

FEB. 1925

RADIO 35 CENTS

BROADCAST

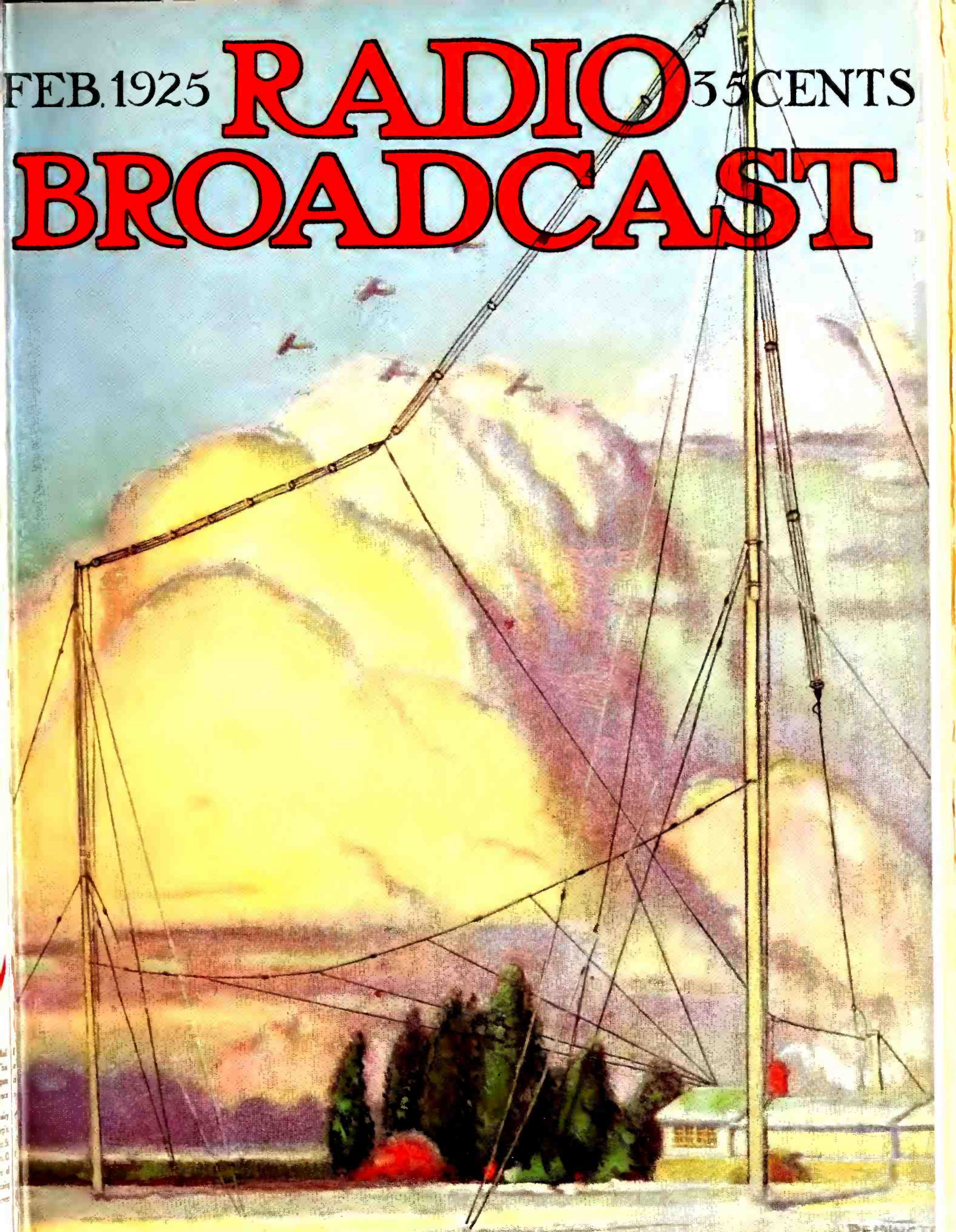

REMYNCTE SCHUYLER

A COMPLETE REPORT OF THE
International Radio Broadcast Tests

DOUBLEDAY, PAGE & COMPANY

GARDEN CITY, NEW YORK



*Magic Notes
from Golden
Throats*

Both the magic and the golden tone quality are retained if your receiving set is equipped with Cunningham Tubes. To detect accurately, to amplify clearly, to give the utmost in radio reception—that is their job. Cunningham Tubes serve long and well. They combine the rarest scientific accuracy with rugged durability.

Since 1915 standard for all sets

Types C-301A, C-299,
C-300, C-11 and C-12—

*In the Orange and
Blue Carton*

Cunningham
RADIO TUBES



E. J. Cunningham Inc.

Branch
CHICAGO

HOME OFFICE
182 Second Street
SAN FRANCISCO

Branch
NEW YORK



PATENT NOTICE: Cunningham tubes are covered by patents dated 2-18-08, 2-18-12, 12-30-13, 10-23-17, 10-23-17, and others issued and pending.

★ Tested and approved by RADIO BROADCAST ★

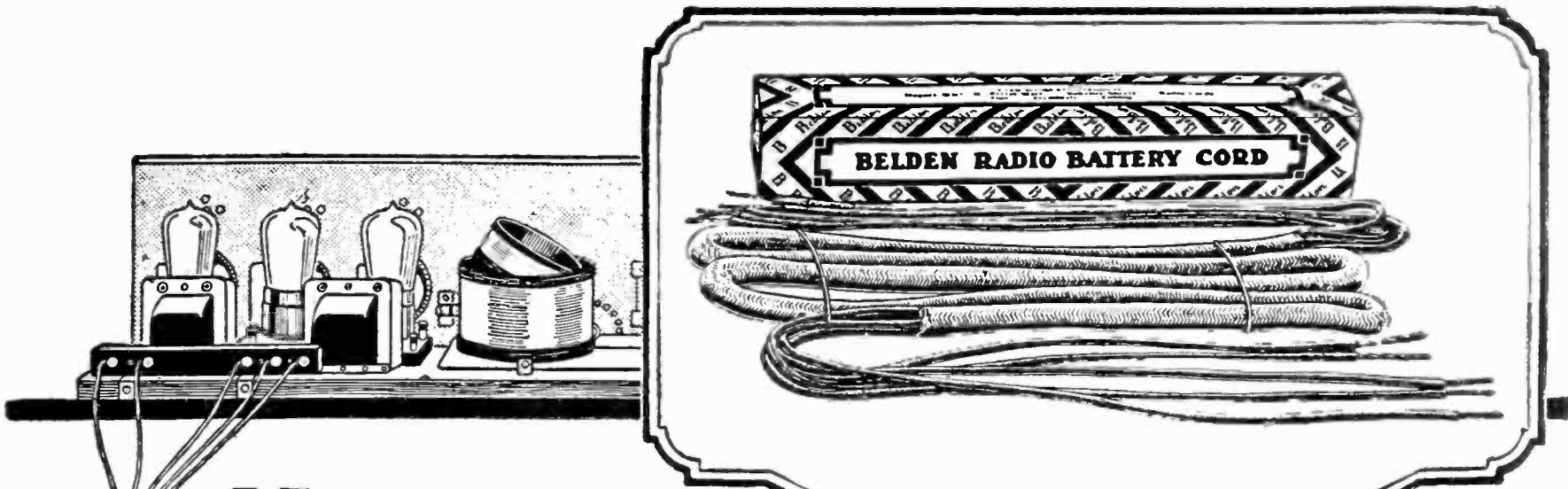

No more crossed wires to burn out your tubes

Color Code

Every conductor is marked distinctly in color to identify each battery circuit.

ONE accidental short-circuit between your A-battery and B-battery wires may burn out every tube in your set. It is folly to spend hours making carefully-soldered connections within the set, and then do a hasty, makeshift job of wiring from the set to the batteries.

The Belden Radio Battery Cord eliminates the danger of short-circuits between wires and insures a neat, compact job of battery wiring that improves the appearance of every set. The five flexible conductors (equivalent to two No. 16 and three No. 18 wires) are rubber-covered and then individually protected with a glazed braid. The five conductors are then enclosed in a glazed brown braid that resists wear and protects the conductors.

Try one of these six-foot Belden radio battery cords, before you burn out any tubes. It is inexpensive insurance against trouble, and you will have a better-looking set.

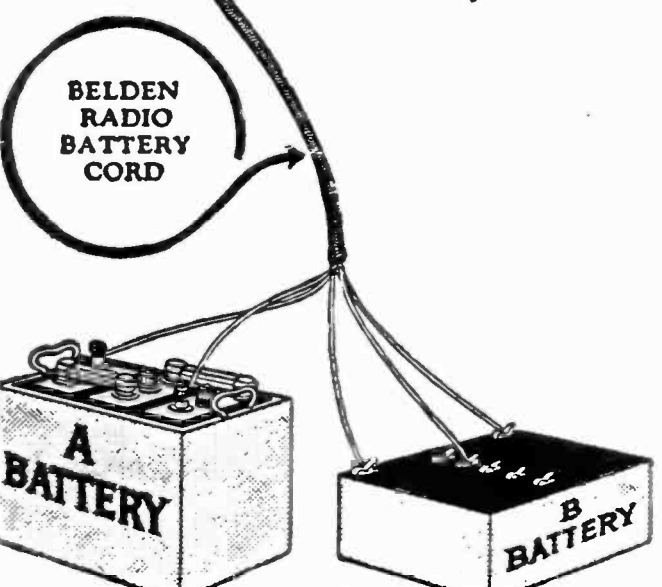

Other Belden Radio Products

Our instructive booklet, "Helpful Hints for Radio Fans," describes many other Belden Radio Products, such as Enameled Aerial Wire, Loop and Litz Wires, New Terminals, Magnet Wire on Small Spools, and many other items. Send for the booklet, right now!

Send for this Free Booklet!



Radio Dealers

Belden Radio Battery Cords are demanded by all careful set-builders. Send for complete dealer bulletin, by writing us on your business letter-head. Write, today!

Belden ★
Manufacturing Company
 2317 South Western Avenue
 CHICAGO, ILLINOIS

Belden Manufacturing Company
 2317 South Western Ave., Chicago, Ill.

Please send me your booklet—Helpful Hints for Radio Fans.

Name _____

Address _____

★ Tested and approved by RADIO BROADCAST ★

Announcing B O S C H

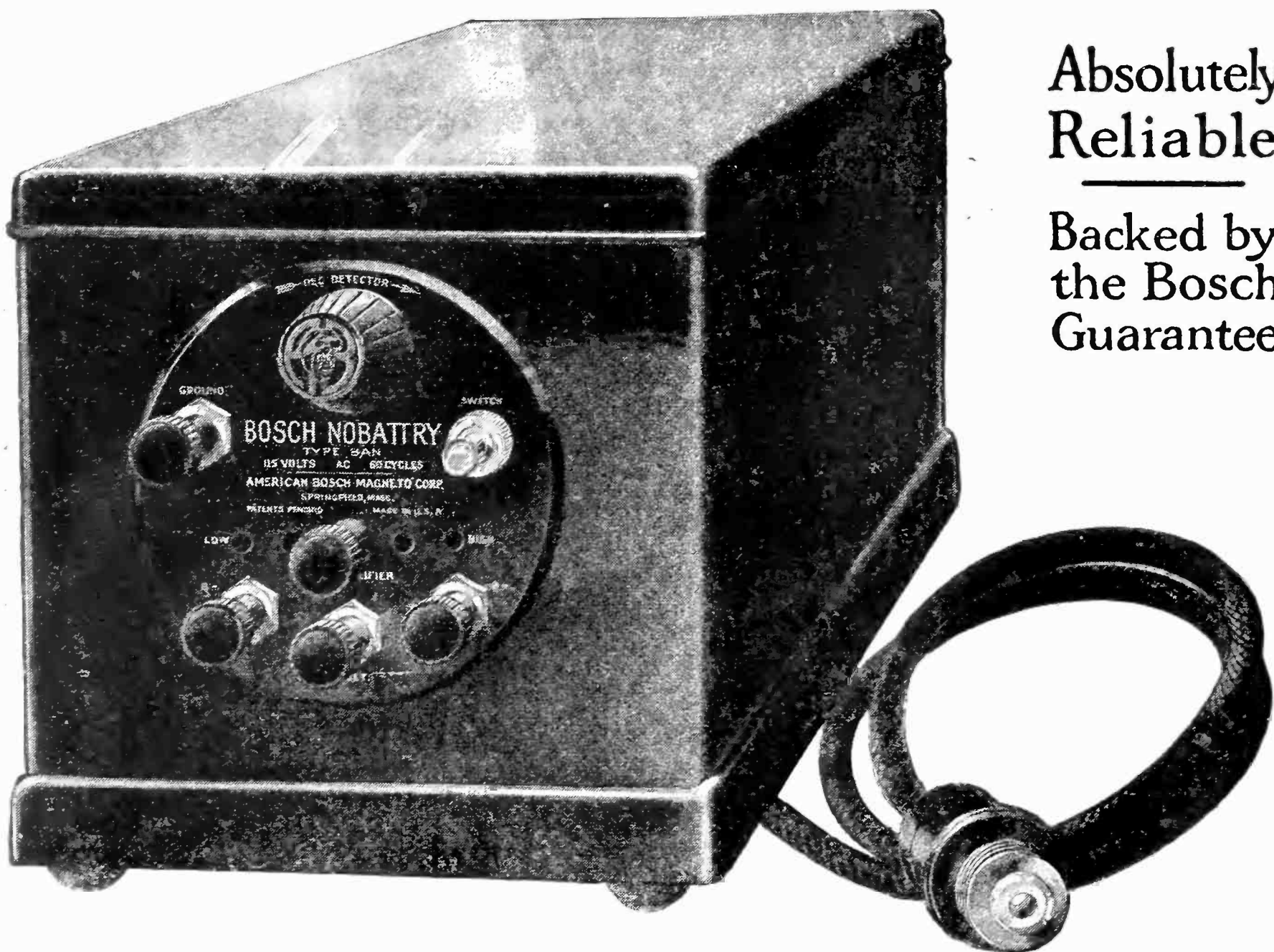

Absolutely
Reliable

Backed by
the Bosch
Guarantee

Delivers "B" current from
the electric light socket

the new

NOBATTERY

The Bosch Nobattery is a device which enables anyone to obtain from an electric light socket perfect and ample plate voltage for radio vacuum tubes. It takes the place of all "B" batteries and is decidedly more efficient, reliable, convenient, and economical.

Bosch Nobattery is a development of the American Bosch Magneto Corporation, which holds a supreme position in the production of fine electrical apparatus. Its great New England manufacturing plants, and its enviable reputation as a producer of high quality precision apparatus should establish immediate confidence in this latest development for the improvement of radio reception.

Do not confuse the Bosch Nobattery with other devices made for eliminating "B" batteries. It is radically different in design and construction, delivering an abundance of current at 15 to 150 volts.

Here's a new radio device you can buy with absolute confidence. It is of the same high quality as all Bosch electrical units, and is backed by the famous Bosch Guarantee of "satisfaction or your money back."

Write for illustrated literature giving full particulars.

DEALERS—Don't delay—the demand is sure to be enormous. Wire to-day for sales proposition and discounts. State whether you are a dealer or jobber, and give references to aid us in quick allocation of territories.

Type BAN for Alternating Current.....\$49.50

Type BDN for Direct Current.....30.00

AMERICAN BOSCH MAGNETO CORP.

Main Office and Works: Springfield, Mass.



Chief Points of Superiority

1. Suitable for any receiving set, using 1 to 14 tubes—will also take care of power amplifier.
2. Unlimited current supply.
3. Requires no attention—does not run down or wear out.
4. Cannot burn out radio tubes even if wrongly connected.
5. Uses no tubes—there's nothing to repair or replace.
6. Costs only a fraction of a cent to operate.
7. Detector voltage adjustable—from 15 to 50 volts.
8. Amplifier voltage adjustable, too—from 90 to 150 volts.
9. Constant voltage—plenty of pep.
10. Gives clear tone, greater volume, and more distance.
11. It is NOISELESS—there's absolutely no hum or distortion.
12. Will operate low power transmitting sets.

Built by the makers of the
world famous Bosch Magneto

Making the New Bradleydenser

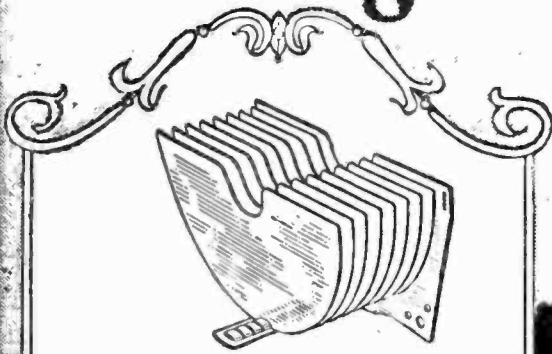

The brass stator plates are soldered to notched spacer bars that maintain perfect alignment.

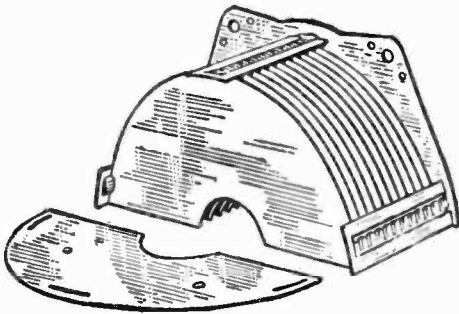

Plates, spacer bars and end plates are all soldered into a solid unit.

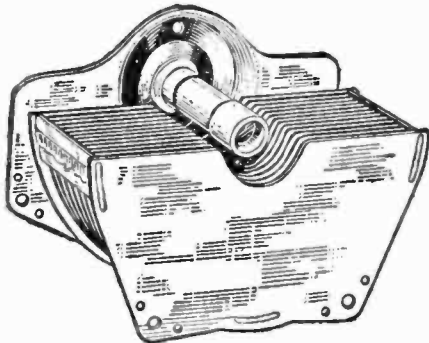

The bearing stud, attached to the stator mounting plate, supports the rotor. See illustration at bottom of this page.

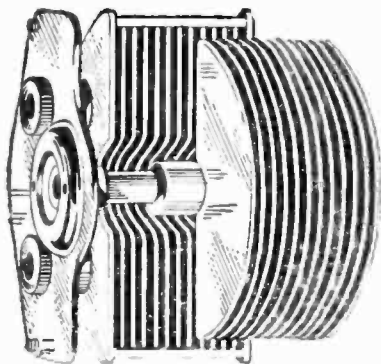

Rotor revolves on a double bearing that is independent of the dial shaft.

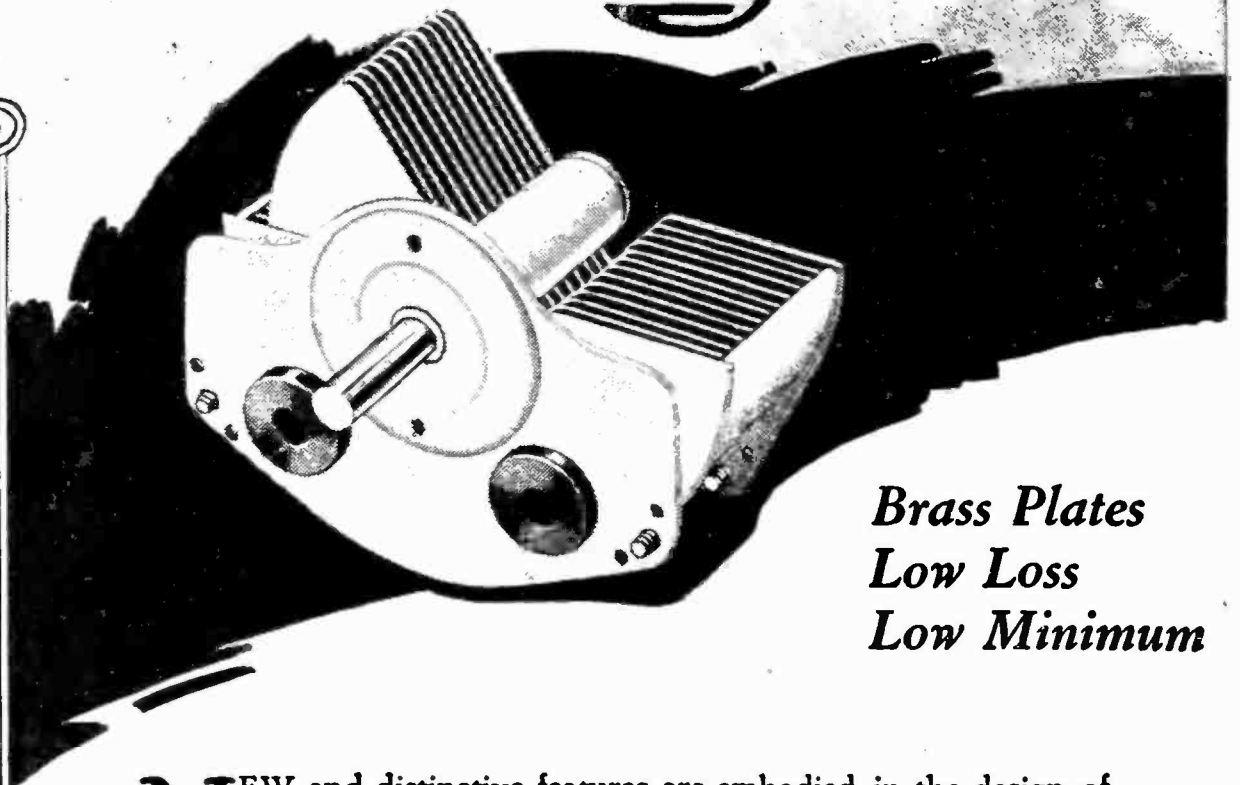

*Brass Plates
Low Loss
Low Minimum*

NEW and distinctive features are embodied in the design of the Bradleydenser. For instance, the rotor revolves on a long double bearing that preserves rigid alignment and yet eliminates the extra outer end-plate. This reduces the amount of di-electric material and increases the efficiency.

Every joint is soldered. This, combined with the use of brass plates, further increases the operating efficiency. Another feature is the dust cap over the stator plates; it is removable without tools.

The Bradleydenser is made in four sizes: 0.00025 M-f. at \$4.50; 0.00035 M-f. at \$4.75; 0.0005 M-f. at \$5.00; and 0.001 M-f. at \$6.00. Leading radio dealers are showing them, now.

Allen-Bradley Co.

Electric Controlling Apparatus

278 Greenfield Ave., Milwaukee, Wis.

Manufacturers of Electric Controlling Apparatus for Over Twenty Years



Disassembled view of the Bradleydenser, showing bearing construction, rotor assembly, and detachable dial shaft. The shaft does not carry the weight of the rotor.

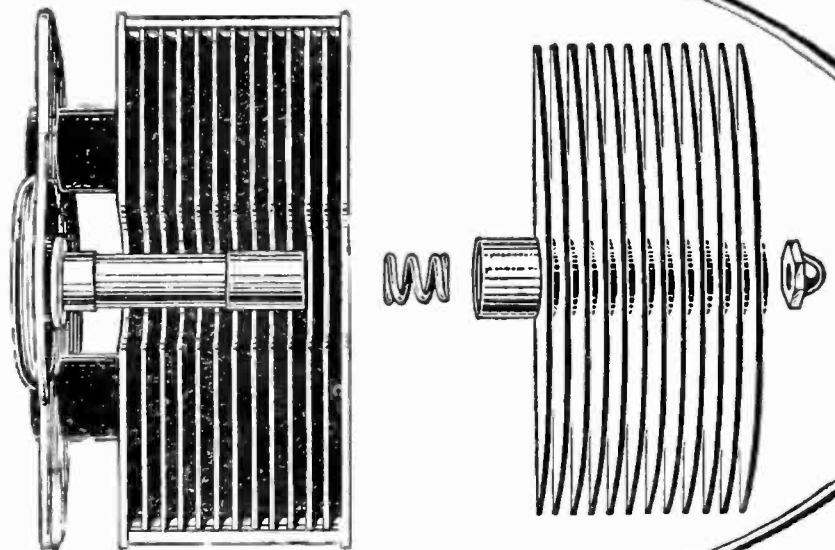

★ Tested and approved by RADIO BROADCAST ★



Use
Any Tube

UV-200 or C-300



Volts - 5
Amps. - 1
Grid Leak
0.5-2
Megohms
Condenser
.00025
.0005 M-f.

UV-201A or C-301A

Volts - 5
Amps. - .25
Grid Leak
2-9
Megohms
Condenser
.00025 M-f.



WD-12 or C-12



Volts - 1.1
Amps. - .25
Grid Leak
2-3
Megohms
Condenser
.00025 M-f.

WD-11 or C-11

Volts - 1.1
Amps. - .25
Grid Leak
2-3
Megohms
Condenser
.00025 M-f.



UV-199 or C-299



Volts - 3
Amps. - .06
Grid Leak
2-9 Megohms
Condenser
.00025 M-f.



Have you used the Bradleyswitch?
It saves batteries and tubes.

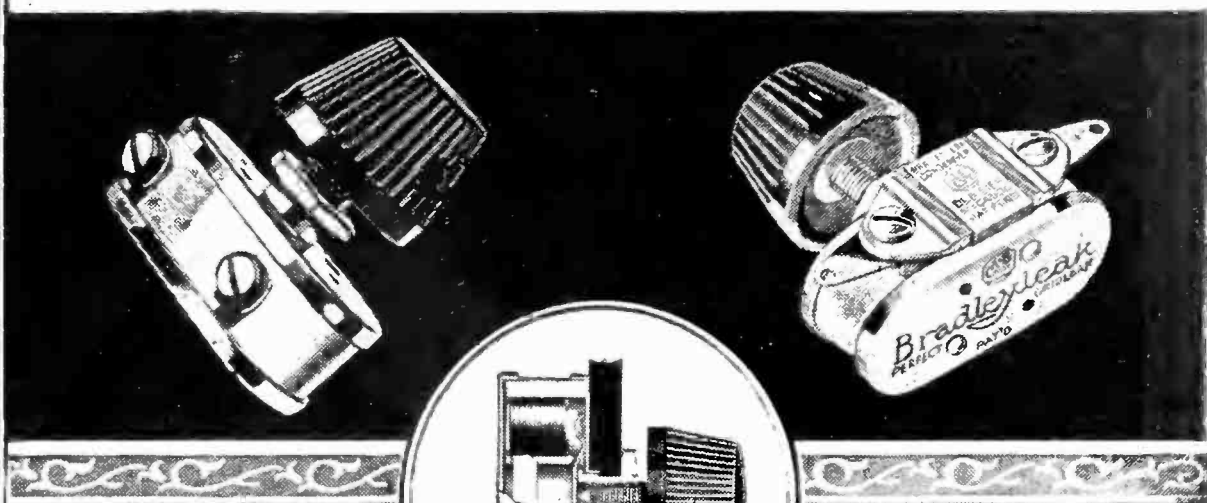

Bradleystat
PERFECT FILAMENT CONTROL

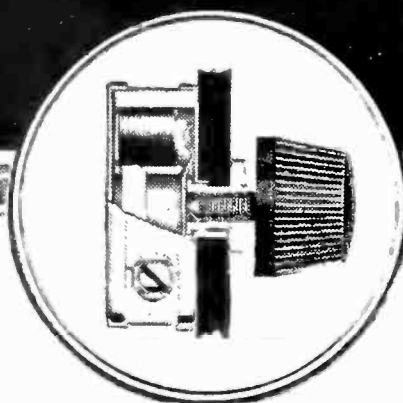

Bradleyleak
THE PERFECT GRID LEAK

Do You Know—

*that any tube can be used in your set?
without changing rheostats or grid leaks?*

IT sounds unbelievable, but it's true. The perplexing problem of selecting the correct rheostat or grid leak is solved by using the Bradleystat and the Bradleyleak. They offer the most marvelous range without steps or noise, and such smooth precision of control that no other rheostat or grid leak can approach them in performance.

The Bradleystat has a resistance range from approximately 1/4 to 100 ohms, by merely turning the adjusting knob that varies the pressure on the graphite discs. It will handle *all tubes* without change of connections, and provide ample control in every case.

The Bradleyleak, with a range from 1/4 to 10 megohms, can be adjusted instantly for any tube, indicated in the adjoining table of tube ratings, by turning the adjusting knob.

Be ready to use any tube in your radio set. Install Allen-Bradley Radio Devices, throughout.

★ **Allen-Bradley Co.**
ELECTRIC CONTROLLING APPARATUS

Sales Office:
Baltimore
Birmingham
Boston
Buffalo
Chicago
Cincinnati
Cleveland
Denver
Detroit



Sales Office:
Evansville
Los Angeles
New York
Philadelphia
Pittsburgh
Saint Louis
Saint Paul
San Francisco
Seattle

General Offices and Factory: 278 Greenfield Ave. Milwaukee, Wis.

Manufacturers of graphite disc rheostats for over 20 years

The MASTER



L. M. COCKADAY

HAS CHOSEN

GENERAL INSTRUMENT
NOLOSS CONDENSERS
FOR HIS SUPER-HETERO-
DYNE REFLEX RECEIVER

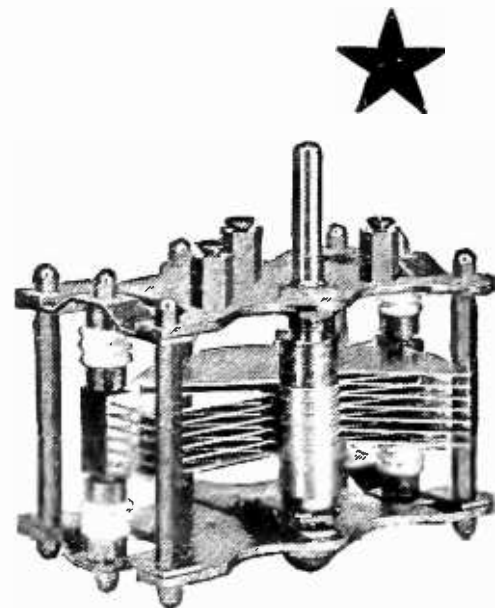

★ Tested and approved by RADIO BROADCAST ★

Hello Central!

Give Me London

THE Final accomplishment of the Super-Heterodyne Reflex Receiver engineered and developed by Mr. Lawrence M. Cockaday as described in the January issue of Popular Radio!

Mr. Cockaday with his Super-Heterodyne Reflex Receiver has proven the fundamental theory that infinite increase of signal strength is accomplished by the decrease of losses.

Real signal strength is the basic necessity for obtaining distance.

With Mr. Cockaday's Super-Heterodyne Reflex Loop Receiver, London was heard clearly on a loud speaker. Paris came in clearly on a loud speaker and Mexico City as though it were a local station.

The following stations were heard clearly and distinctly on a loud speaker with Mr. Cockaday's Super-Heterodyne Reflex Receiver November 27, 1924, in the presence of a representative group of distinguished Radio Engineers.

2LO—London, England
 5NO—Newcastle, England
 2BD—Aberdeen, Scotland
 5PY—Plymouth, England
 ESP—Paris, France
 WKA₂—Porto Rico
 CYC—Mexico City, Mexico

General Instrument No Loss Condensers were used in Mr. Cockaday's set.

This epoch making achievement of Mr. Cockaday is one great step forward to the ultimate radio inter-communication between continents.

The engineering staff of the General Instrument Corporation has assisted in the furtherance of experiments by designing and building variable condensers through which such accomplishments have been made possible.

General Instrument No Loss Condensers are practically without losses. They are designed with engineering skill—built with laboratory precision—mechanically rugged in frame to withstand the hardest abuse—worthy to be used in Mr. Cockaday's remarkable receiver—worthy to be used by you.

General Instrument Corporation

Manufacturers of Laboratory Equipment

423 Broome Street, New York

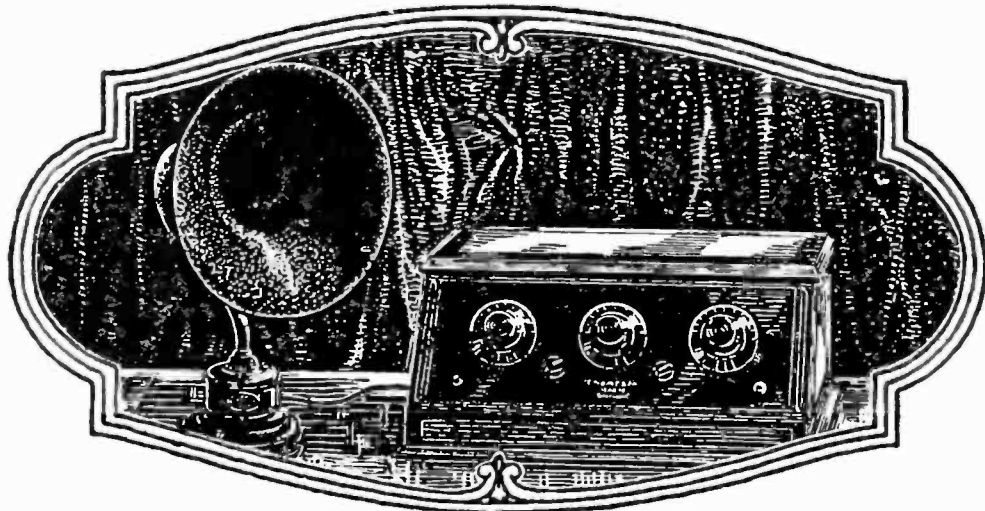

"Experience is the Vital Factor in Excellence"

THOMPSON RADIO

THE Thompson Organization is unique among radio manufacturers in having a background of 15 years experience in designing, developing and manufacturing intricate and delicate radio apparatus for the armies, navies and commercial institutions of the world.

During this time its research laboratories have perfected developments which have contributed largely to the advancement of the radio industry.



This wide experience, now available in the Thompson apparatus, means Receivers and Speakers that embody the latest and best practice in Radio Engineering. A critical investigation of each model will disclose outstanding features of genuine excellence — in artistic appearance, naturalness of tone, simplicity of operation.

Thompson Receiving sets range in price from \$125 to \$180. The Thompson Speaker is now \$28.

Write for attractive literature and name of Thompson dealer near you.

R. E. THOMPSON MANUFACTURING CO.
30 CHURCH STREET
NEW YORK, N. Y.

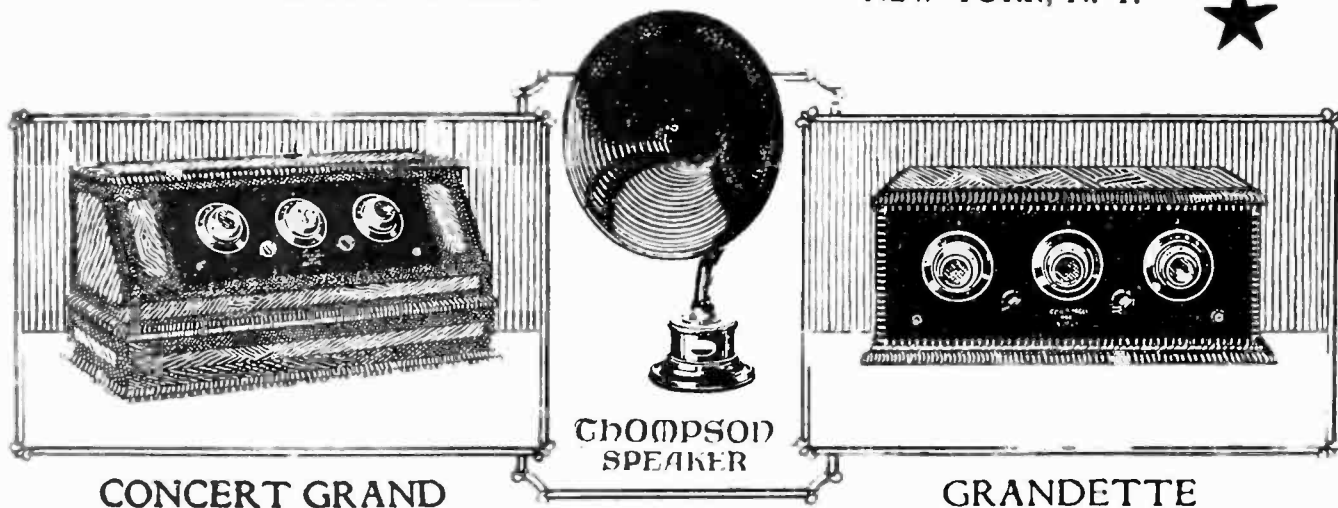

CONCERT GRAND

THOMPSON
SPEAKER

GRANDETTE

★ Tested and approved by RADIO BROADCAST ★

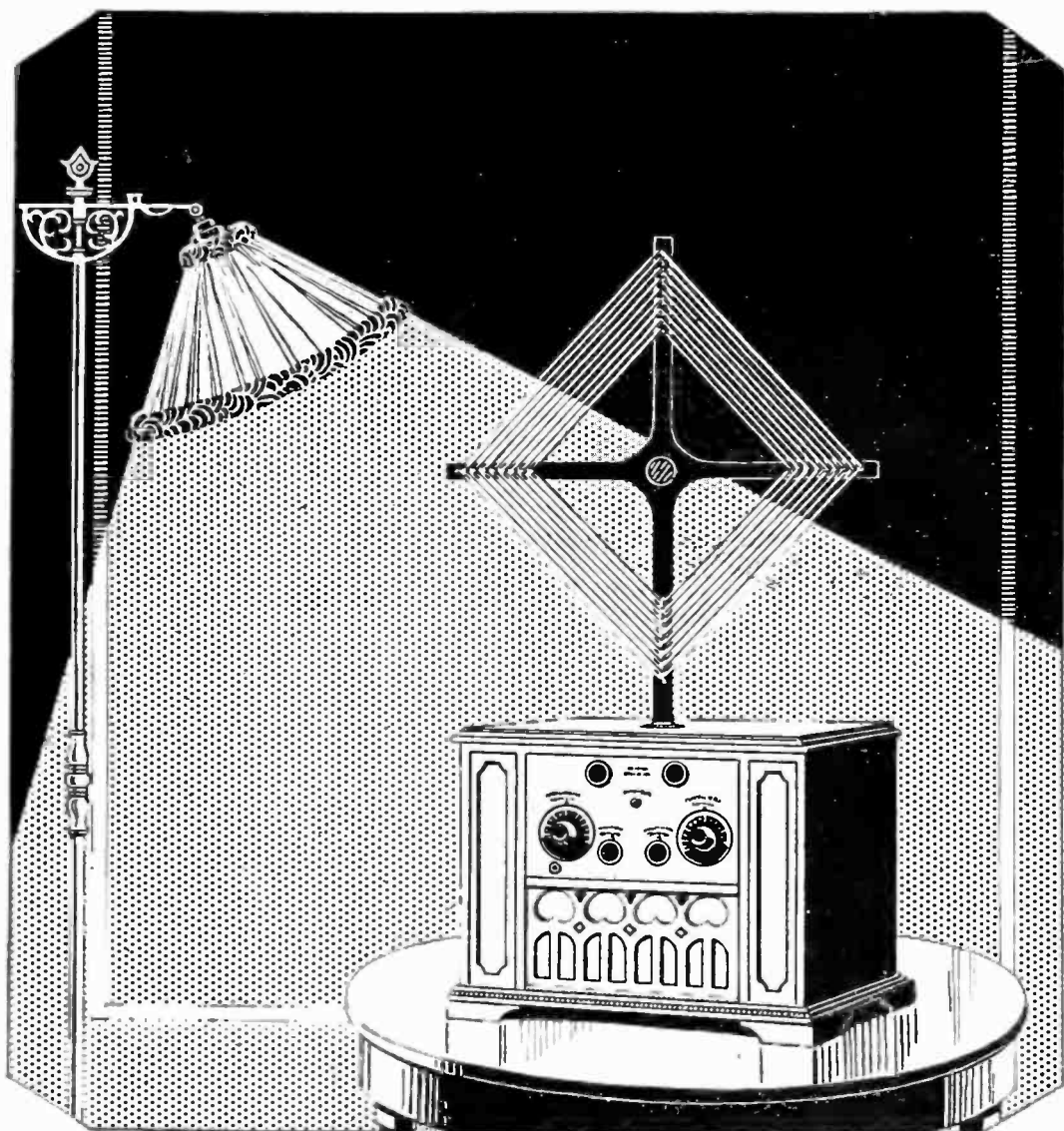

De Forest Radiophone

*Requires no aerial—
no ground wire*

Batteries, De Forest Loud Speaker and Tubes complete within cabinet.

Easily movable from room to room, it is ready to operate within five minutes after it is delivered to your home.

You have the radio habit now! *You'd better have a De Forest*

WHETHER you have an instrument or not, whether you know it or not, you have the radio habit already. Do you go to the theatre? Do you go to political meetings? Do you read the day's news? Do you seek contact with people who offer either amusement or information? Then you're essentially a radio fan, for radio is giving many of the best of these things in a way in which they cannot be obtained elsewhere.

The De Forest is a complete and self-contained instrument with a loop the size of a picture frame instead of an aerial wire, with batteries and loud speaker self-contained.

It can be easily moved from room to

room. It has a remarkable tone quality. It brings out the voice or instrument as sincerely and truthfully as the performer himself does. And it is an immediate result-getter that is simple to operate!

Whatever there is in radio, the De Forest can give it to you. It yields good results from the beginning and gradually increasing results as your skill grows. *There is nothing else like it.*

It will pay you to look up a De Forest Agent

He is willing and equipped to teach you the simple technique of using the De Forest. Let him demonstrate it in your own home.

DE FOREST RADIO COMPANY, Jersey City, N. J.

Also makers of De Forest Tubes—The "Magic Lamp" of Radio



DE FOREST RADIOPHONE

REG. U.S. PAT. OFF.

REG. U.S. PAT. OFF.

★ Tested and approved by RADIO BROADCAST ★

The UTAH
Trade Mark Registered
 Made In Salt Lake City

\$25.00

Phono-Speaker \$10.00



GUARANTEE

Buy a UTAH and use it for two weeks. Compare its tone with the best others are able to produce. If the UTAH does not give at least 50% better reception, return it to your dealer and he will cheerfully refund your money.

NOW! *Radio Music as You Never Heard it Before*

YOU never heard such tone! You cannot guess the wonderful musical possibilities of radio reception until you hear UTAH reproduction.

Rich, mellow, natural tones of instrumental music—the delicate shadings of the human voice—satisfactory volume from a weak and distant station—or big volume from a strong station, without the rasping and blasting that big volume has always caused—That's UTAH reproduction!

The new UTAH Speaker is the latest triumph of acoustical and electrical engineering—the result of two years work by the leading experts in sound reproduction.

Hear It!

Go at once to your dealer's store and ask for a demonstration. Or better yet, take a UTAH home with you and enjoy it for two weeks under our unprecedented guarantee.

UTAH Radio Products Co., 1427 Michigan Ave., Chicago

★ Tested and approved by RADIO BROADCAST ★

The Latest ★ Achievement of the



GENERAL RADIO LABORATORY



The current radio season has seen the advent of many new audio transformers—some of them worthy contributions to better amplification.

Now comes the announcement of the new General Radio transformer which sets an even higher standard of amplification and places the erstwhile leaders in the mediocre class.

Discriminating radio listeners—this instrument has been designed for you. It is an achievement of which the designing engineers are justly proud; it is an instrument which merits the admiration of trained radio ears.

High and low notes are amplified evenly

over the whole audio range so that instrumental or vocal tones are reproduced individually or in combination with a naturalness which delights the most critical radio listener.

Seldom is more than one transformer necessary to operate a loud speaker with good volume.

If you want the best there is in transformer design, the type 285 should be your choice.

Price \$7.00.

Ask for them by name.

At all Reliable Radio Dealers.

GENERAL RADIO CO.
Cambridge, Mass.

GENERAL RADIO CO.



Cambridge, Mass.
U.S.A.

★ Tested and approved by RADIO BROADCAST ★

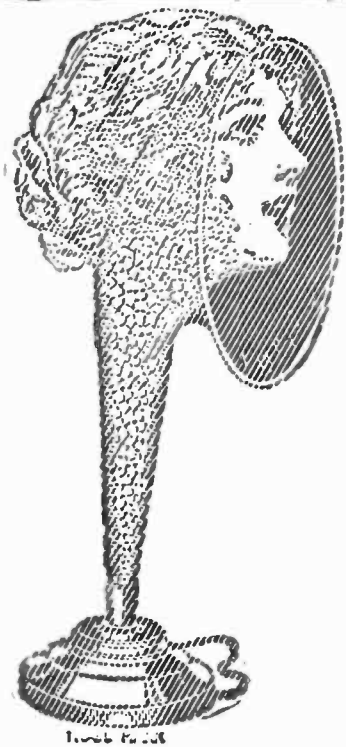

Atlas

TRADE MARK

RADIO REPRODUCTION speaker

You DO NOT want just noise from your radio set.

Tone-range, quality, clarity, volume; each, alone, just noise. But their balanced combination as from Atlas Speakers "gives the best that's in your set". This is balanced Atlas Radio Reproduction.



MULTIPLE ELECTRIC PRODUCTS CO., Inc.
365 Odgen Street, Newark, N. J.
(Dept. W.)

New York, Boston, Philadelphia,
Baltimore, Pittsburgh, Detroit,
Chicago, St. Louis, San Francisco.

Marconi Wireless Telegraph Co.
of Canada, Ltd.
Sole Canadian Distributors

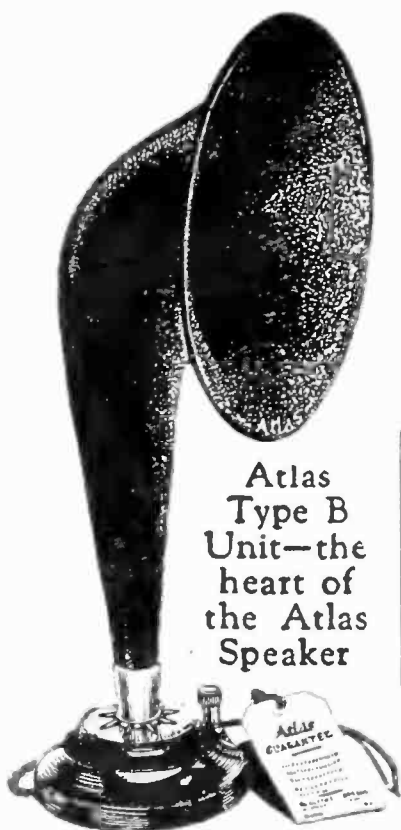

Atlas Model 101 Speaker

Atlas Type B Unit—the heart of the Atlas Speaker

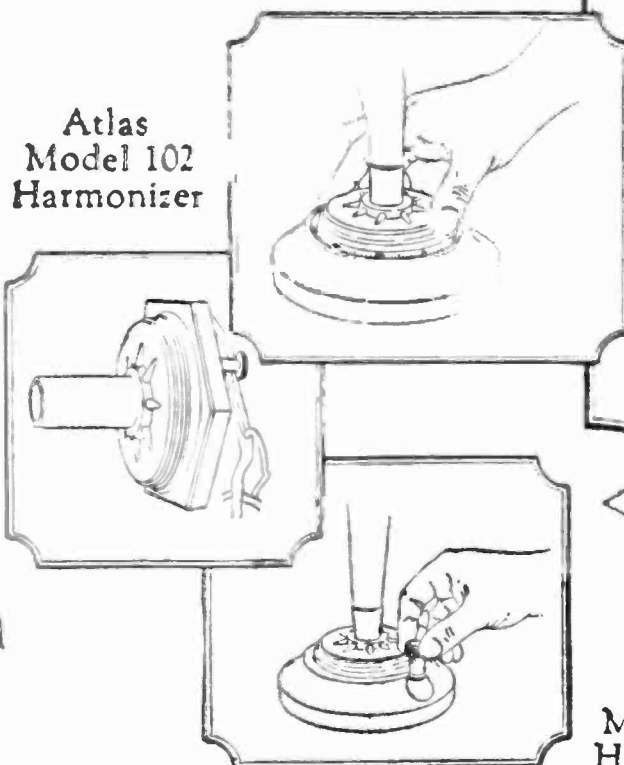

Atlas Model 102 Harmonizer

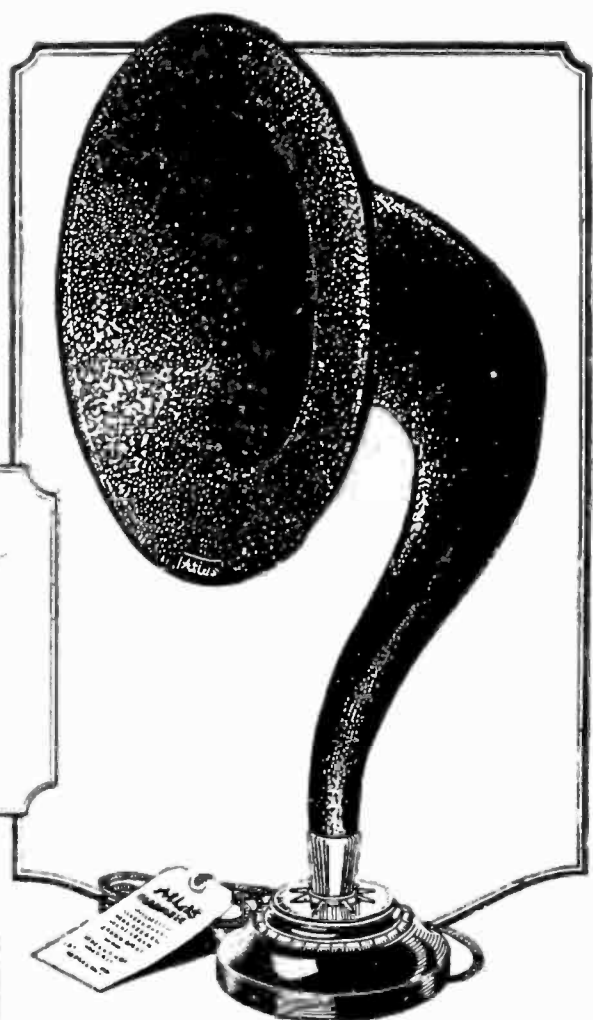

Atlas Model 102 Speaker

Atlas Model 101 Harmonizer

★ Tested and approved by RADIO BROADCAST ★

The instrument for you—if you are particular



ROYAL ELIZABETHAN

Model 150. Combination phonograph and radio. Walnut or mahogany. Price \$350 with loud speaker, less accessories.

You will surely find it in this beautiful line of Royal radio and phonographs

THERE is an instrument in the Royal line of radio and phonographs that will not only meet your wishes for better home entertainment but also give you exactly the enjoyment you desire. Whether you want to hear the programs of the radio broadcasting stations or the most beautiful records, a Royal instrument will reproduce the tones perfectly.



ADLER-ROYAL NEUTRODYNE

Floor Type No. 1 Elizabethan. Dry cells or wet "A" Batteries. 5 tubes. Walnut or mahogany. Price \$350, including loud speaker, without tubes or batteries.

Royal gave to the public a better phonograph which thousands welcomed for its superior tone and beautiful cabinet designs. Now in Adler-Royal Neutrodyne it has simplified radio so that any one can operate it. Merely by setting the dials at certain numbers the radio stations are brought in without the discordant noises that have been associated with some types of radio. You have your choice of two different styles. Set 201A operates with the usual "A" storage battery. Set 199 operates on dry cells.

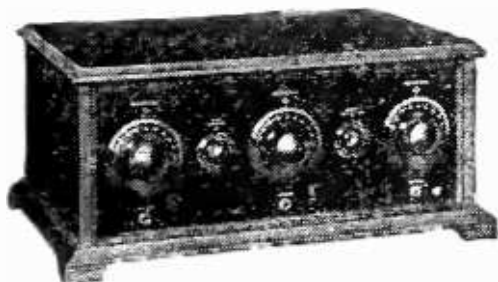

ADLER-ROYAL NEUTRODYNE

Model 201A operates with "A" storage batteries. 5 tubes. Walnut or mahogany. Price \$160. Complete with accessories \$215.

Adler-Royal is on exhibit only at the higher class stores whose reputation is an additional guarantee of the quality of the Royal line.

You will be only fair to yourself if you examine the Royal line and compare it with all others in quality of workmanship, tone reproduction and price.

ADLER MANUFACTURING COMPANY, Inc.
General Sales Office: Dept. C2, 881 Broadway, New York City
Factories: Louisville, Ky.

ADLER-ROYAL *Phonograph and Radio*

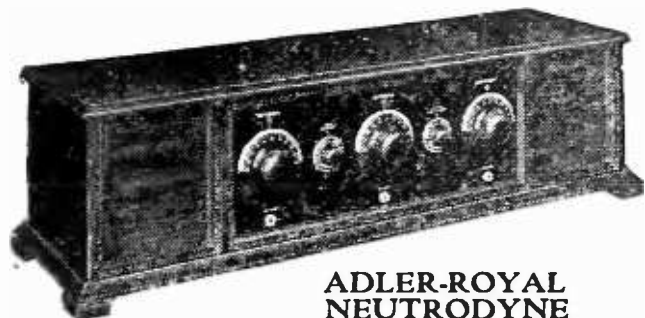

ADLER-ROYAL NEUTRODYNE

Model 199 Table Type used with dry cells. 5 tubes (199) Cabinets walnut and mahogany. Price \$165. Complete \$205.



ADLER MANUFACTURING COMPANY
Dept. C2, 881 Broadway, New York City

Please send me the Adler-Royal illustrated booklet and log.

Name.....

Address.....



The Adler-Royal Neutrodyne is licensed under the Hazeltine Neutrodyne Patents and manufactured for us by King-Hinners Radio Co.

★ Tested and approved by RADIO BROADCAST ★

You can give your set
this big advantage—

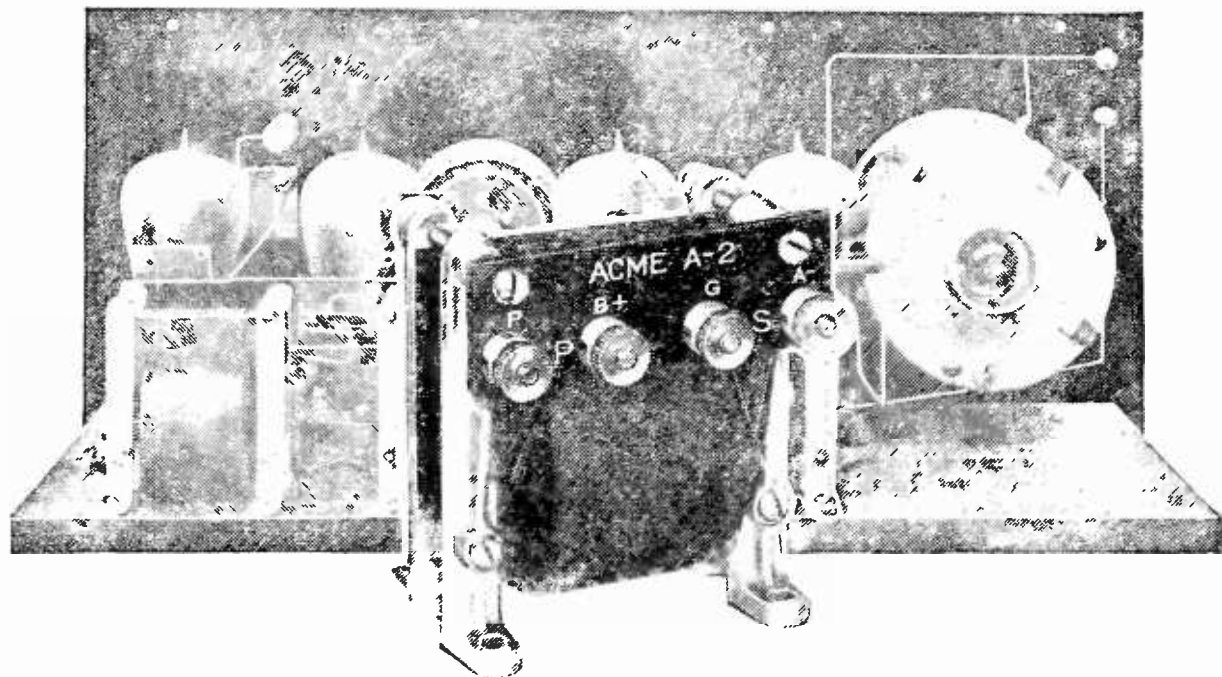

Amplification without Distortion

*How to make sure of getting
everything loud and clear*

YOU can make your set so that it will reproduce clearly and distinctly without distortion. The real pleasure in radio comes when you can understand and enjoy what you hear—voices that are natural—music that is clear in tone. In order to hear clearly and distinctly you want to be sure that you are using amplifying transformers that amplify the sound without distorting it.

Give your set this big advantage—Amplification without Distortion. Whether you have a neutrodyne, superheterodyne, regenerative or reflex the addition of the Acme A-2 Audio Amplifying Transformer will make it better.

The Acme A-2 has become famous among radio owners for increasing the volume of sound without distorting. It has improved thousands of radio sets. If you are bothered by distortion, try an Acme A-2 and note the difference.

Each transformer is tested and carries a guarantee tag. If you want Amplification without Distortion use Acme Transformers in the set you build and insist on them in the set you buy. (That's one of the big reasons why the Acme-reflex Kit-set gives such good results—it uses Acme Transformers.) Send for our 40-page booklet which explains how to get the best results by proper amplification and also contains a number of valuable wiring diagrams. It will help you build a set. Mail the coupon with 10 cents.

ACME APPARATUS COMPANY
Transformer and Radio Engineers and Manufacturers
Dept. F1 Cambridge, Mass.



Have the fun of making your own radio set

ACME

~ for amplification

ACME APPARATUS COMPANY,
Dept. F1, Cambridge, Mass.
Gentlemen:

I am enclosing 10 cents (U. S. stamps or coin) for a copy of your book, "Amplification without Distortion."

Name

Street

City..... State.....

"For Amplification Without Distortion" use ACME Transformers in the set you build. Insist on them in the set you buy and enjoy all the year round Radio

The Amplifying Transformer is the Magnifying Glass of Radio

Type 6-D Broadcast Receiver

Non-oscillating ~ Non-radiating

IN dollar-for-dollar value, the 6-D Receiver leads the field.

This remarkable Receiver excels in every phase of performance—purity of tone, sharpness of tuning, range, volume and ease of operation.

You can pay more, but you cannot buy better reception. By all means, examine the 6-D before making a final selection.



EISEMANN MAGNETO CORPORATION

165 Broadway, New York

DETROIT

SAN FRANCISCO

CHICAGO

SPECIFICATIONS

Circuit: Two stages of tuned radio frequency amplification, detector and two stages of audio frequency amplification. Non-oscillating.

Tubes: Five in all. Jacks provided for either five or four tube operation.

Batteries: Either storage or dry-cells.

Cables: Complete set sup-

plied for "A" and "B" batteries.

Condensers: Single bearing, low leakage losses.

Sockets: Suspended on cushion springs which absorb vibrations.

Cabinet: Mahogany, with distinctive lines and high finish. Ample space provided for "B" batteries.

Panel: Aluminum, with

attractive crystal black finish. A perfect body capacity shield.

Dials: Sunken design. Shaped to fit the hand and permit a natural position in tuning.

Wave lengths: 200 to 600 meters, with uniform efficiency of reception.

Aerials: 75 to 125 feet, single wire.

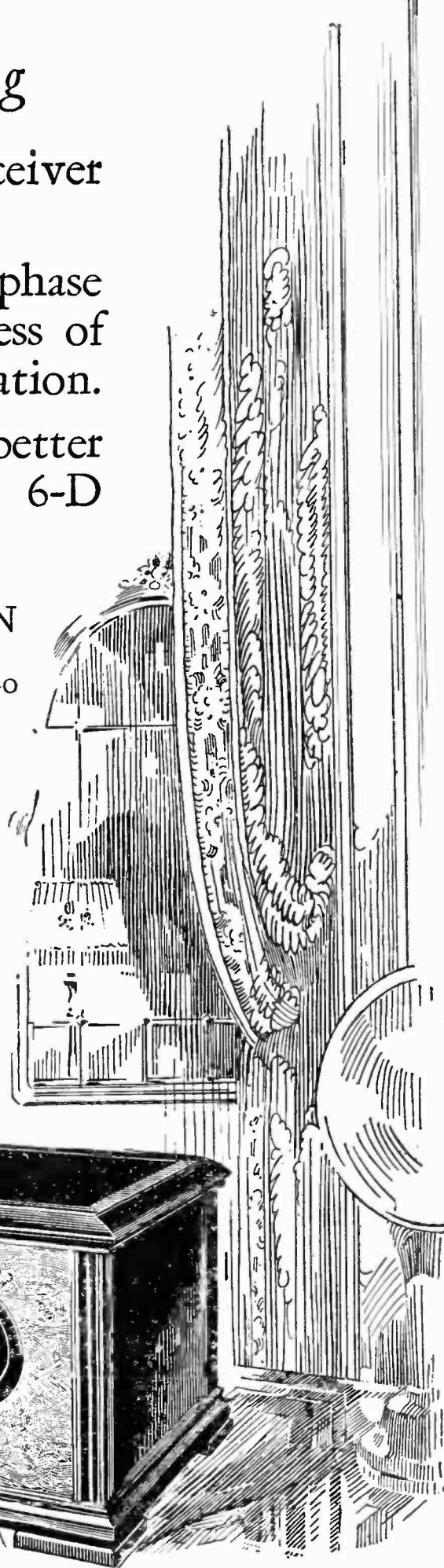

Price \$125.00

without accessories

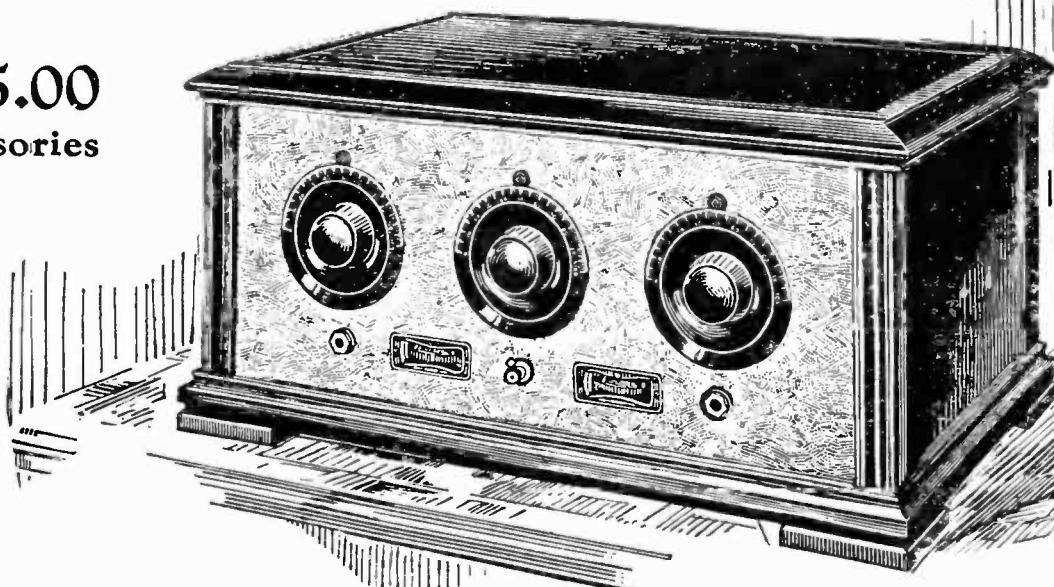

EISEMANN

ELECTRICAL EQUIPMENT

★ Tested and approved by RADIO BROADCAST ★



Each Instrument in PERFECT TUNE



WHEN you tune in a large orchestra, do you hear a great wave of pure harmony? Or do the upper tones of the violins, flutes, oboes and clarinets come in a trifle "flat"?

Because it is itself a true musical instrument, the Bristol Audiophone brings in each instrument and each vocal note in perfect tune. This—not mere noise—is what you should demand in a loud speaker; for it makes all the difference in the world in the performance of your set.

The Bristol line includes five Audiophones, priced from \$12.50 to \$30.00. If not at your dealer's, write for Bulletin AH-3011.

The Bristol Company, Waterbury, Conn.

**Model S
Audiophone
\$25.00**

Rubber horn
14½" in diameter.
Cast metal
throat. Velvet
mat finish of mot-
tled bronze and
gold.

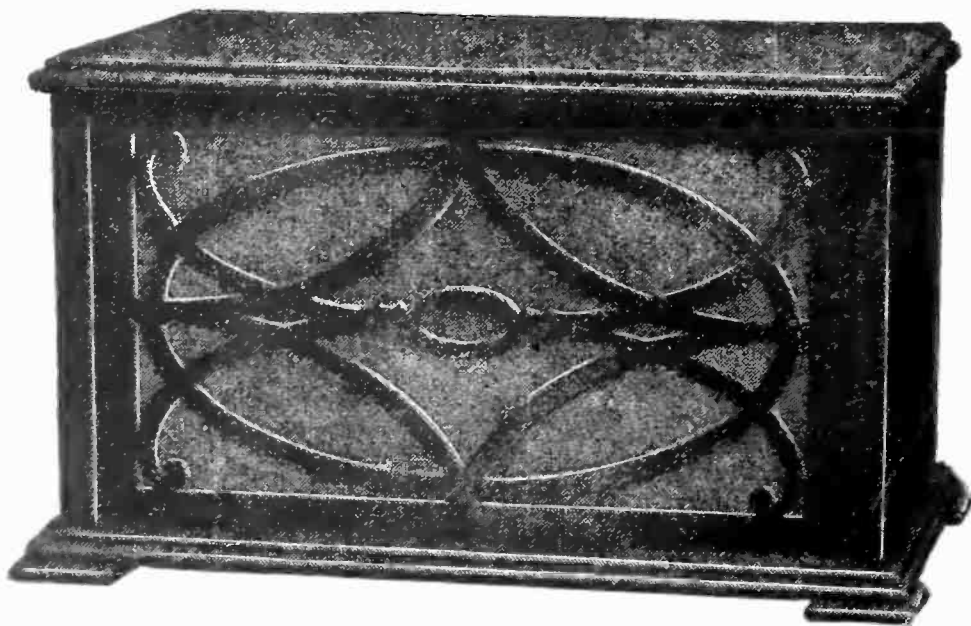

Cabinet Model \$30.00

Beautifully finished mahogany. Full floating wooden horn and cast metal throat. Musically, a companion to the finest set ever built; size 17 x 10 x 10½".



BRISTOL TRADE MARK
AUDIOPHONE REG. U.S. PAT. OFFICE **Loud Speaker**

★ Tested and approved by RADIO BROADCAST ★



Patented
May 15, 1923

Experts Praise Device Which Takes Place of B Batteries

THE radio set owner who has looked forward to the time when he could simply plug in on his house lighting circuit (110 volt 60 cycle A. C.) and obtain the plate current for his set, doing away with B batteries, now has ample reason to purchase a B-Limiter with complete confidence in the results.

He has the endorsement of a great many thousands of B-Limiter owners plus the recommendation of experts who have tested B-Limiters even more exhaustively.

For instance, Captain Robert Scofield Wood, radio editor of the New York World, says in his paper, "The quality of the reception when using this B-Limiter as compared with new B batteries will be found much finer. The signals seem crisp and lifelike."

Andrew McLean Parker, radio expert and radio editor of the Camden (N. J.) Post Telegram, says: "We are genuinely enthusiastic over this device."

Thomas Appleby, founder of the first Wireless School in America and President of Executive Radio Council, 3rd (United States) Radio District, said, "Reception was perfect when using a B-Limiter in connection with a five-tube set."

Just three of the enthusiastic endorsements.

But here you have enough proof to send you to the nearest good dealer for a B-Limiter. Take it home. Learn its operation—how both detector and amplifier plate voltages can be regulated to the fractional part of a volt. Find how convenient it is and how dependable. Ask your dealer for complete information on the Timmons B-Limiter and other Timmons Tested Products. If you prefer, write us direct for literature on all Timmons Products.

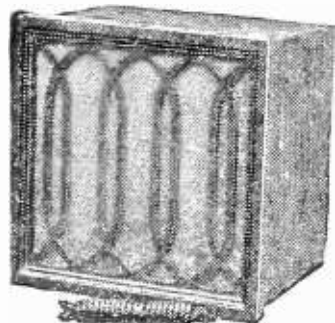

Type N (Non-Adjustable)

Price, \$18

Timmons Talkers

Type A (Adjustable)

Price \$35

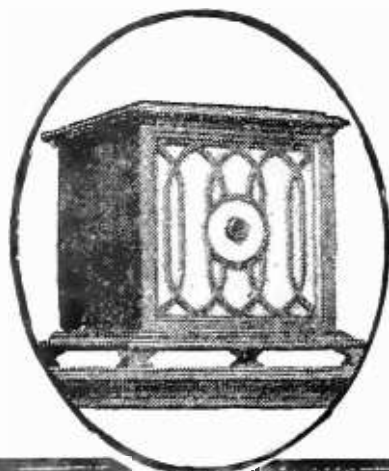

TIMMONS



GERMANTOWN



PHILADELPHIA

★ Tested and approved by RADIO BROADCAST ★

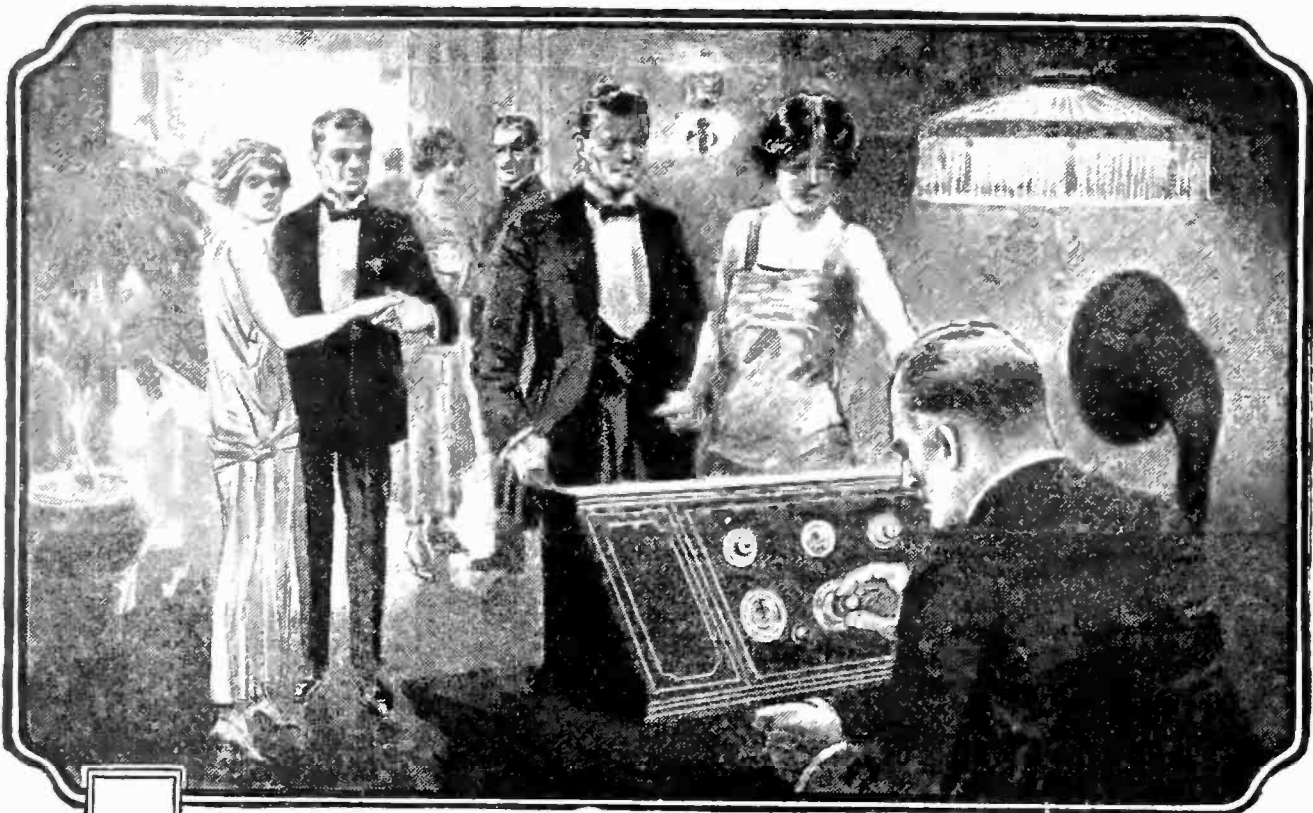

Are you ready to TUNE IN that DISTANT STATION?

NOTHING is more discouraging to a radio fan than to find his batteries down on a good night—too weak for distant reception.

A weak battery is a noisy battery and, further, current flow is irregular—the reception comes and goes.

A great many pleasant evenings have been spoiled by weak batteries. Hours have been wasted tinkering—when a weak battery was the cause of all the trouble.

The Westinghouse Rectigon Battery Charger is the friend of every radio fan. It will charge your battery over night.

The Rectigon will enhance many fold the pleasures of radio reception. It can be obtained at a small cost.

Make a Rectigon a part of your equipment and forget battery troubles.

See our nearest dealer.

Westinghouse Electric & Manufacturing Company
South Bend Works South Bend, Indiana
Sales Offices in All Principal Cities of
the United States and Foreign Countries

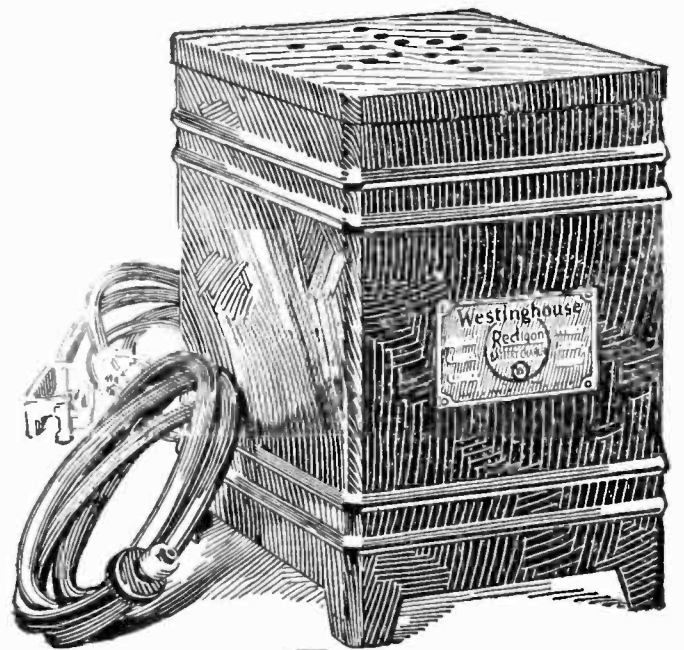

Westinghouse

★ Tested and approved by RADIO BROADCAST ★

A New Star

The Eaglet 3 Tube
Dry Cell
Neutrodyne

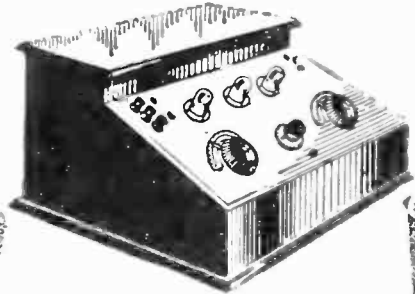

\$ **75**

**The World's Greatest
Popular Priced Set**

Manufactured and Guaranteed by
EAGLE RADIO CO.

Makers of
The Famous Models A and B
**EAGLE NEUTRODYNE
RECEIVERS**

Your protection for quality
and unparalleled

VALUE

Ask the Dealer—He Knows



EAGLE RADIO CO.
19 Boyden Place, Newark, N. J.

★ Tested and approved by RADIO BROADCAST ★

DAVEN RADIO PRODUCTS

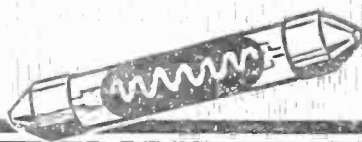
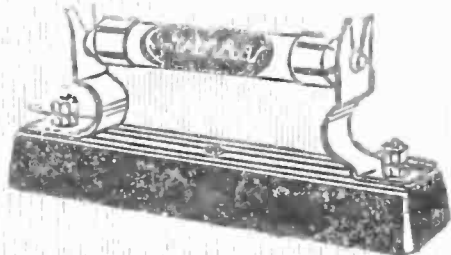
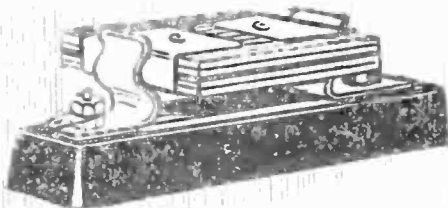
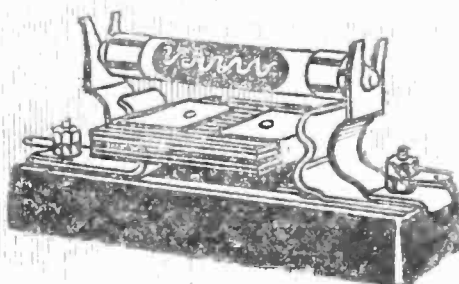
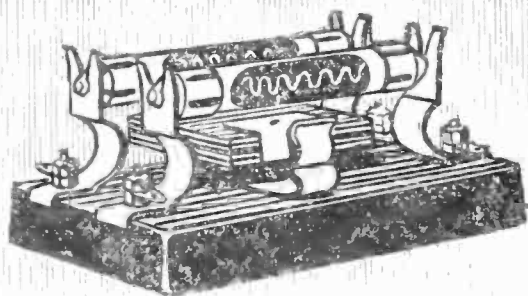
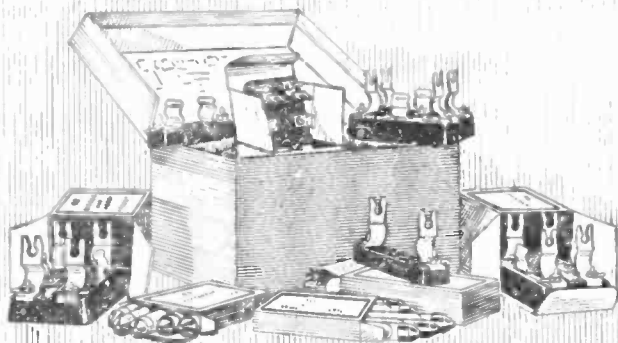
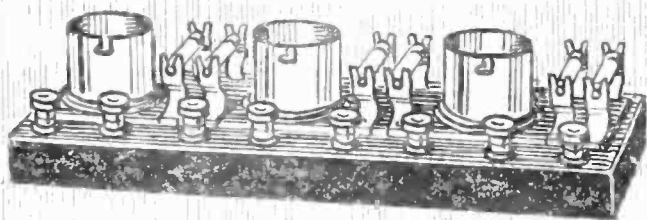

THE history of the Daven Radio Corporation dates back before the days of Radio Broadcasting. Its engineers have concentrated their efforts in the perfection of amplifying devices, which have been copied and duplicated by others, but their quality never equalled.

In perfecting the Daven Resistance Coupled Amplifiers, many careful laboratory experiments were made at great expense. The SUPER AMPLIFIERS and the knock-down kits are the results, and have convinced the most skeptical that Resistance Coupling is the ultimate method of amplification.

The SUPER-AMPLIFIER comes to you in complete form, ready to install. All the connections are underneath the molded Bakelite base. It gives wonderful volume, and is absolutely distortionless.

THE KITS are for those who prefer to build their own. They are easy to assemble and may be used in any standard tuning circuit. Sockets and mica-fixed condensers are not included, but instructions are furnished giving complete information and diagrams. Supplied for either three or four stages.

Ask your dealer for our 25c booklet "The RESISTOR MANUAL" which tells all about the many possibilities of Resistance Coupled Amplification and how to use it.

TRADE MARK

DAVEN RADIO
"The Sine of Merit"
CORPORATION ★
Resistor Specialists

Newark

New Jersey

The Aristocrat of Amplifiers

★ Tested and approved by RADIO BROADCAST ★

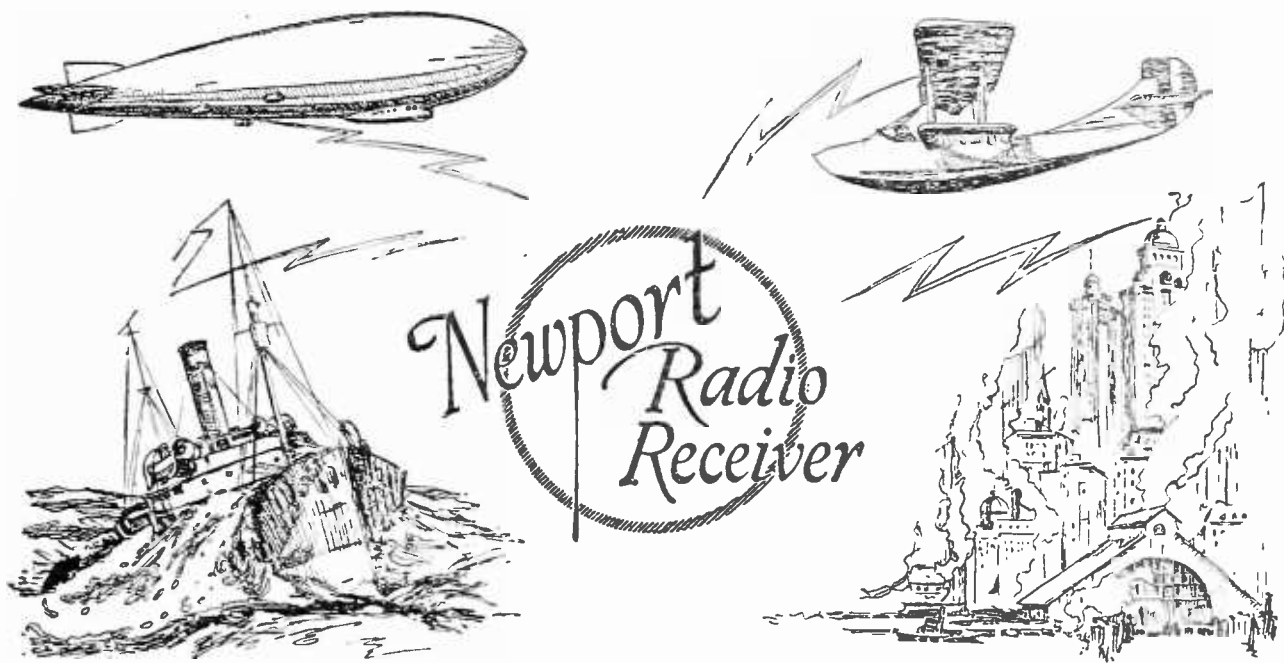

Beckon the World to your Fireside Via the Newport

The distance getting ability of the Newport Radio Receiver will tumble the world into your living room.

Your Newport will bring to you the capricious music of to-day or the romantic arias that have stirred Time; it will permit the leaders of human thought and enterprise to discuss with you, privately, any subject in which you are interested; it will bear to you the thrill of tense moments in sportdom. The aviator flying so nonchalantly over your housetop will tell you what he is seeing from the pilot's seat. The diver is explaining the mysteries and beauties of the ocean's depths. One can almost "feel" the ship ploughing her way through the seas, so colorful and realistic are the interesting programs broadcast by the Atlantic liners. One of the great dirigibles has broken from its mooring mast! Can she be saved? The crew will tell you via your Newport.

All the drama and romance of present time are at your beck and call through the distance getting ability of the Newport.

*The Newport is a Good Receiver
Built in a Piece of Fine Furniture*



Newport Radio Corp.
1250 West 54th Street,
New York City



★ Tested and approved by RADIO BROADCAST ★



TWIN GIANTS

IT requires *good* audio transformers to take the output of the detector tube and add nothing but volume. And AmerTrans are real giants when harnessed to the task of transforming weak signals into clean-cut, enjoyable, loudspeaker entertainment. Give the audio side of your set the consideration it deserves and use a pair of AmerTrans.

{ AmerTran is made in two types, one quality—
A F 6 — ratio 5: 1 and A F 7 — ratio 3½: 1.
Buy them by the pair! }



AMERICAN TRANSFORMER COMPANY

181 EMMET STREET, NEWARK, N. J.

"Transformer builders for over twenty-three years"

Price either model \$7.00
At your dealers.

AMERTRAN
TRADE MARK REG. U.S. PAT. OFF.

Send for leaflet giving useful
amplifier information.

★ Tested and approved by RADIO BROADCAST ★

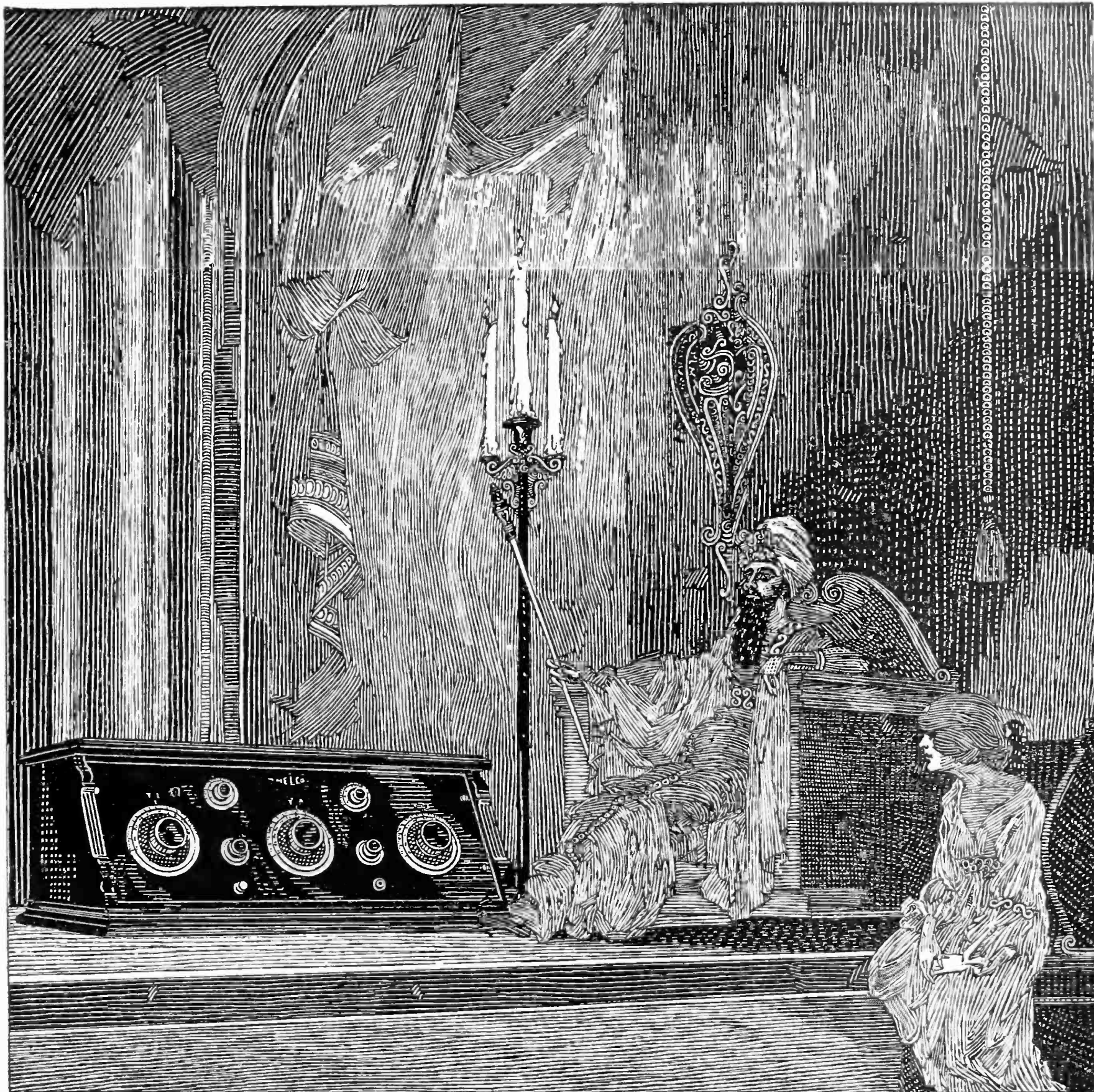

A Thousand and One Nights Entertainment

The MELCO is a silver-tongued Scheherezade — offering a thousand and one nights entertainment.

Entertainment without interference, noises and fade-aways. Supreme radio reception—Full-toned, clear-throated true to life.

Ask for interesting literature

MELCO SUPREME RECEIVER ★

TUNED RADIO FREQUENCY

AMSCO PRODUCTS INC. BROOME & LAFAYETTE STREETS, N.Y.



★ Tested and approved by RADIO BROADCAST ★

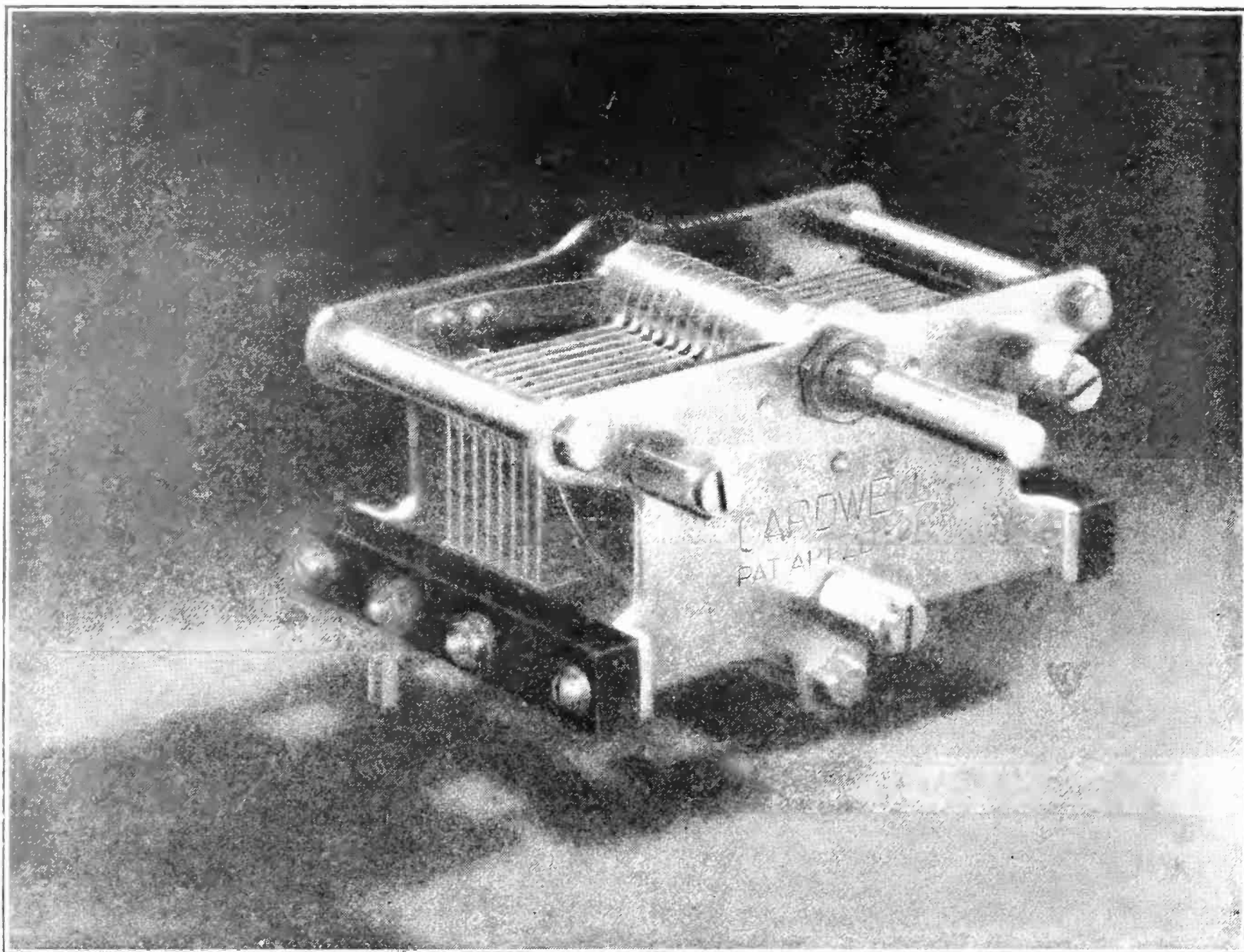

Insist on **CARDWELLS**

The *first* "low-loss" condensers

★

CARDWELL invented the original *low-loss* condenser, using metal end plates and a grounded rotor. The phrase "low-loss" was in fact first applied to Cardwell Condensers by engineers to distinguish these highly efficient condensers from the ordinary varieties.

Cardwell Condensers have been universally adopted by radio editors, experts, and professionals. Cardwells have become the standard of comparison.

Performance is the only real test of a condenser. And Cardwell Condensers have proved their superiority because of their scientifically correct

design—small area of contact between insulation and stator supports, rigid three-point frame, permanent alignment, accurate adjustment, etc.

Such details permit exceptional distance records, smooth tuning free from noise, and prevent changes in capacity at given settings.

Use Cardwell Condensers in all receivers. There's a Cardwell Condenser for every requirement—seventy-six different types. A post-card brings you an education on condensers.

Allen D. Cardwell
Manufacturing Corporation
81 Prospect St., Brooklyn, N. Y.

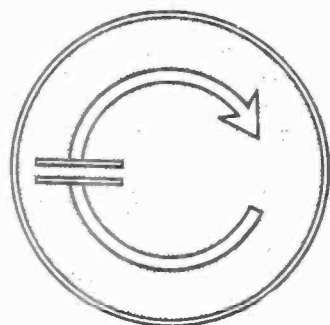

TRADE MARK
 Registry Applied For

★ Tested and approved by RADIO BROADCAST ★

GOLDEN-LEUTZ
PLIODYNE-6

TRADE MARK REG.

"The Perfect Broadcast Receiver"

\$60.00

**COMPLETELY
 CONSTRUCTED**

WITHOUT ACCESSORIES

Transportation Prepaid

A New Superior Broadcast Receiver

**SIMPLE—LONG RANGE—HIGHEST QUALITY—
 NON RADIATING—NON REGENERATIVE**

**Two Stages Tuned Radio Frequency, Detector and
 Three Stages of Audio Frequency Amplification**

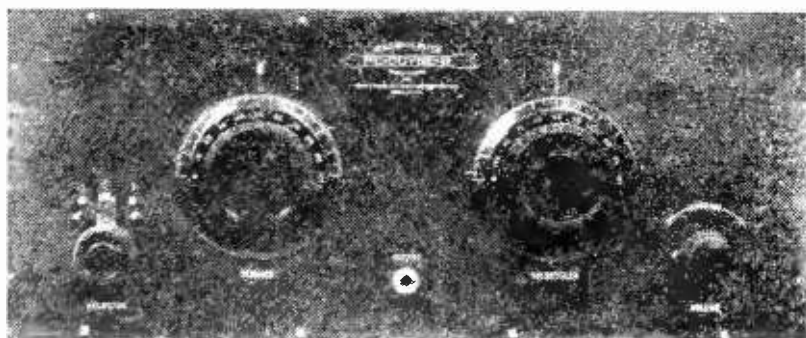

PLIODYNE 6
 Front View Showing Simplicity of Control

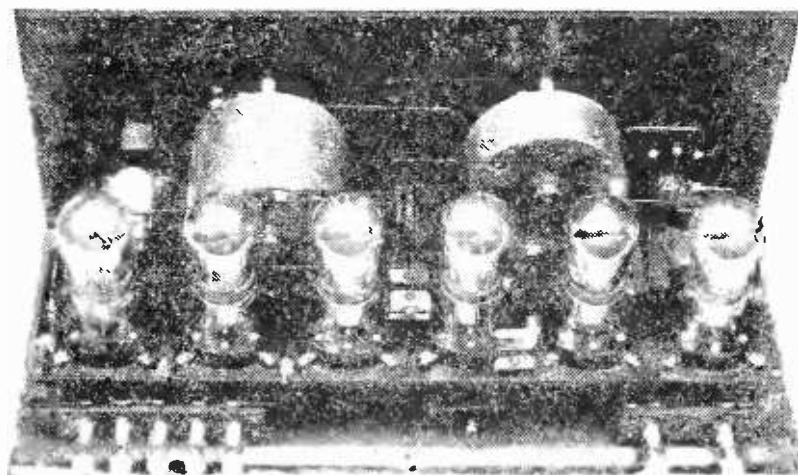

PLIODYNE 6
 Interior View Showing Compact and Efficient Design

A New Marketing Plan

Rather than sell this high grade receiver to wholesalers at \$120.00 less 50% discount, we are going to sell it direct to you at wholesale, saving you \$60.00 and at the same time giving you the finest set that can be bought for twice the amount.

Our Guarantee

We guarantee every GOLDEN-LEUTZ "Pliodyne 6" to be the finest broadcast receiver that can be manufactured using 6 tubes or less and to be satisfactory to you in every way and to reach you in perfect condition.

GOLDEN-LEUTZ, Inc.

476 BROADWAY

NEW YORK CITY

LICENSED UNDER FARRAND AGREEMENT AND HOGAN PATENT NO. 1,014,002

★ Tested and approved by RADIO BROADCAST ★

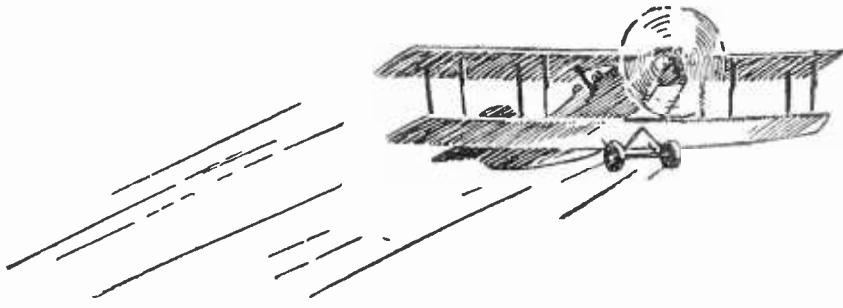

Bringing to earth the airplane type receiver

RADIO frequency transformers as designed by Jackson H. Pressley, Chief Engineer, Radio Laboratories, U. S. Signal Corps, Camp Vail, New Jersey, and manufactured by the Sangamo Electric Company, assure you of precision instruments.

The essential needs for airplane use are:

First—Extreme compactness with maximum amplification per transformer stage;

Second—A transformer so designed that there is negligible coupling between stages no matter how they are spaced;

Third—Stability without the aid of manual controls.

It was only after months of experimenting that Mr. Pressley was able to attain these results, and the adoption of his transformers as standard for airplane use speaks for itself.

A set of these radio frequency transformers and coupler coil will be delivered anywhere in the United States for \$22.50 (Introductory Price).



ASSOCIATED SANGAMO ELECTRIC COMPANIES

CAPACITY 3500 METERS PER DAY

SANGAMO ELECTRIC COMPANY
Springfield, Illinois

BRITISH SANGAMO COMPANY LIMITED
Pondersend, Middlesex, England

SANGAMO ELECTRIC COMPANY
OF CANADA LIMITED Toronto, Ontario

ASHIDA ENGINEERING COMPANY
Osaka, Japan

8820-2

Domestic Offices—New York, Chicago, Birmingham, San Francisco, Los Angeles. Radio Division—50 Church Street, New York

★ Tested and approved by RADIO BROADCAST ★

The Modern "Arabian Nights Entertainment"



Connect the Mu-Rad MA 20 to Any Electric Light Socket and be Entertained without Further Effort ~ ~ ~

"This rug, my master," said the merchant to the prince, "will carry you where you will. Simply express the wish and instantly you are transported".
—Arabian Nights Entertainment

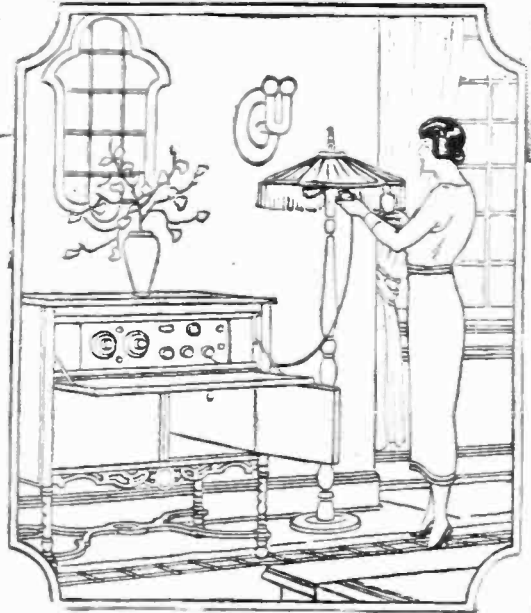

The New MU-RAD RECEIVER MA-20

The Last Word in Radio

THE "magic carpet" expressed the medieval idea of the ultimate in swift transportation. TO-DAY, the radio scientists' conception of the ultimate in radio reception is the new *Mu-Rad Receiver MA-20*. The entertainment from the great cities of a continent at your command with even less effort than playing a phonograph. Select the stations you want simply by turning the dials to certain numbers—always the same. No batteries to wear out or recharge.

NO Antenna or Loop
A or B Batteries
Battery Charger

Cabinet Model MA-20

The MA-20 can also be purchased in a handsome Adam Brown hand-rubbed finish mahogany cabinet with engraved Formica panel.

Write for Literature and the Name of The
★ Nearest Store Where You Can See the
Mu-Rad MA-20

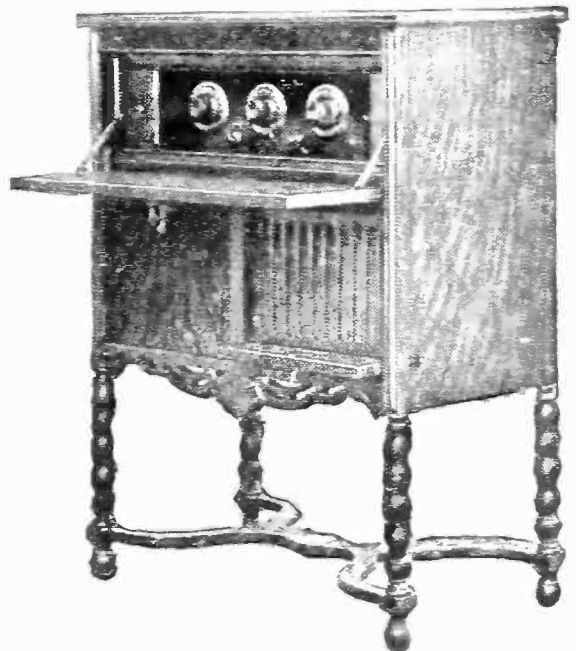

MU-RAD LABORATORIES, INC.

803 FIFTH AVE., ASBURY PARK, NEW JERSEY

★ Tested and approved by RADIO BROADCAST ★



Most Practical Ratio

An ideal operating ratio—not too low nor too high—for infinitely close tuning with perfect ease. A ratio approved by leading radio engineers and proven by the silent endorsement of thousands of users.

New Accuratune Feature

No back lash.
No cutting of condenser shafts.
No wobble of dial.

New Accuratune Micrometer Controls mark an unusual advance in tuning devices! Designed upon a new principle which eliminates all lost motion and back lash. Increasing tuning efficiency over that of any known vernier or tuning device. A truly wonderful instrument—indispensable in DX work.

Accuratune Micrometer Controls fit all standard condenser shafts. Mount flush with panel. Easily replace ordinary dials with no set alterations.

At your dealers, otherwise send purchase price and you will be supplied postpaid. Price \$3.50.

Canadian Representatives

Radio, Ltd.
Montreal



MYDAR RADIO COMPANY, 9-D Campbell St., Newark, N. J.

ACCURATUNE

REGISTERED *GEARED 80 to 1* U.S. PAT. OFF.
MICROMETER CONTROLS

★ Tested and approved by RADIO BROADCAST ★

Adapto

RADIO CABINET

Converts Your Radio Receiver
Into a Thing of Beauty

You can now dress up your radio set—convert it instantly into a beautiful console receiver.

The Adapto Cabinet is uniquely designed to enclose all batteries and accessories. Adjustable mounting frame—to fit any size or any make radio set. A beautiful art design, made of finest woods by skilled cabinet craftsmen. Equipped with inbuilt horn, adaptable to any unit.

Write for Circular.

Furnished in rich mahogany or
walnut finishes.

35" long, 45" high and 18" deep.

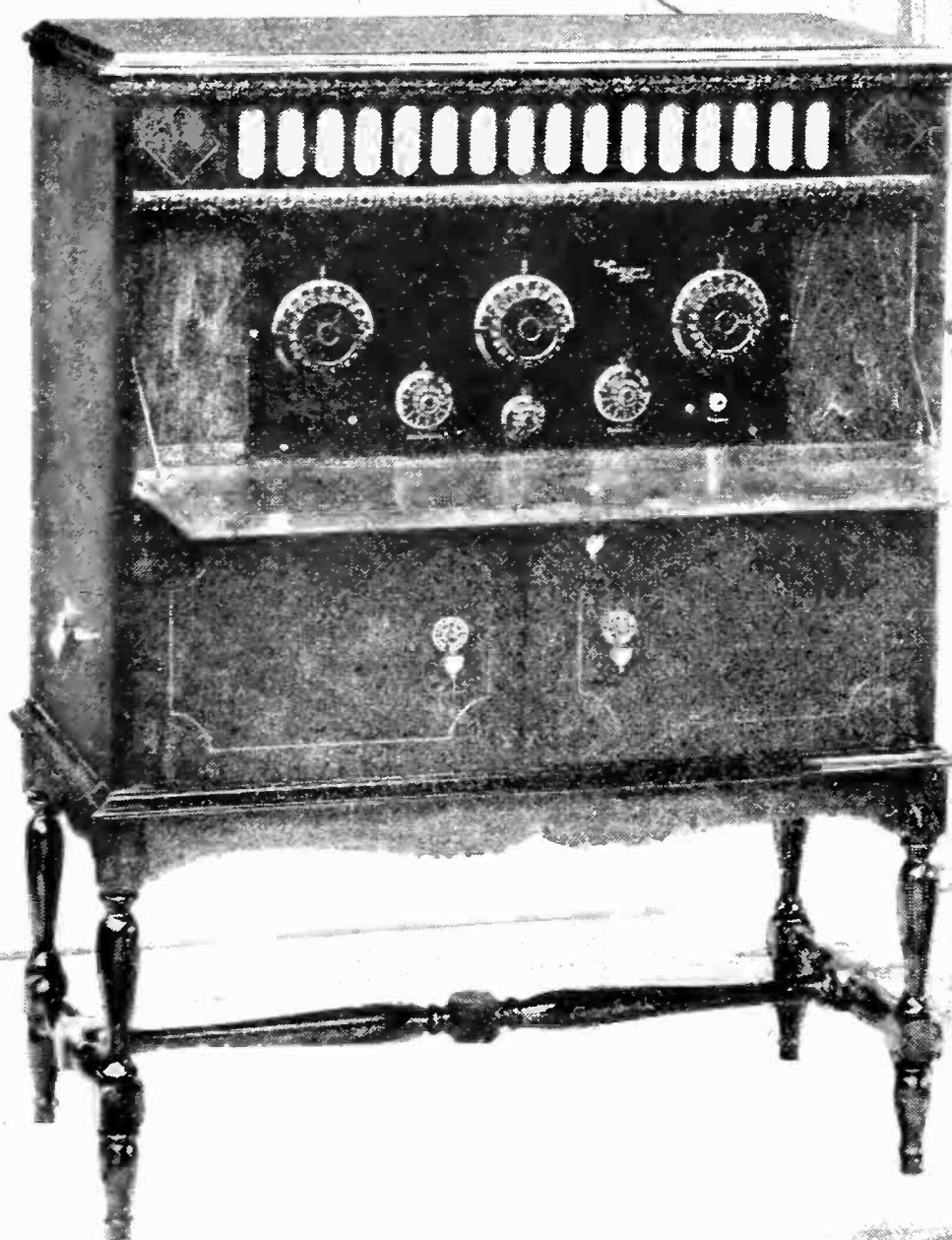

L. R. DONEHUE CO. ~ PERTH AMBOY, N. J.

★ Tested and approved by RADIO BROADCAST ★

FREED-EISEMANN

RADIO RECEIVERS



Here are questions asked you every day:

Is the Neutrodyne the best receiver?—is the FREED-EISEMANN the best neutrodyne?—are dry cell tubes as good as storage battery tubes?—is the loop as efficient as the regulation aerial?

Most times — to most questioners — you shrug your shoulders and say it's a matter of individual preference.

But it isn't. It's a matter of *knowledge*. Each of these questions and many more are answered in our booklet "Buying a Radio" written for the layman, with a personal word for the expert. Your copy comes free for the asking. Write us.

Four-tube and five-tube models. Prices \$100 up. . . slightly higher in Canada and west of the Rockies.

Freed-Eisemann Radio Corporation
Manhattan Bridge Plaza, Brooklyn, N. Y.



★ Tested and approved by RADIO BROADCAST ★

Tower's

Tower's Scientific

THE MOST POPULAR HEADSET

in the World

Sales prove it

\$2.95



Every set tested and approved by government licensed radio operators



The Reason

Out of the jungle of yesterday, leaving behind the maze of inaccurate, uncertain apparatus, TOWER'S Scientific phones have blazed a trail to undisputed leadership, being recognized as the

World's Greatest Headset Value

Millions today enjoy music and entertainment reproduced in those clear, mellow tones so characteristic of TOWER'S Scientifics.

TOWER'S Scientific headsets are guaranteed to be made of the best materials money can buy—highest test enamel, insulated magnet wire, best grade five-foot tinsel cord, unbreakable caps, polished aluminum cases, using the famous scientific head-band constructed for maximum comfort.



If your dealer cannot supply you order direct

THE TOWER MANUFACTURING CORPORATION
98 BROOKLINE AVENUE Dept. I BOSTON MASSACHUSETTS

Scientific

★ Tested and approved by RADIO BROADCAST ★

Radio Broadcast

ARTHUR H. LYNCH, EDITOR

FEBRUARY, 1925

COVER - - - - -	<i>From a Painting by Remington Schuyler</i>	
THE HUB OF THE INTERNATIONAL RADIO BROADCAST TESTS -	<i>Frontispiece</i>	
HOW MICHAEL PUPIN SUCCEEDED - - - - -	<i>Myra May</i>	659
THE WAY OF THE TRANSGRESSOR - - - - -	<i>William P. Green</i>	666
WHAT REFLEX MEANS - - - - -	<i>Julian Kay</i>	671
THE INTERNATIONAL RADIO BROADCAST TEST OF 1924	<i>Arthur H. Lynch and Willis K. Wing</i>	676
THE LISTENERS' POINT OF VIEW - - - - -	<i>Jennie Irene Mix</i>	684
SOME EXPERIENCES WITH THE BLIND AND RADIO -	<i>Charles T. Whitefield</i>	692
THE MARCH OF RADIO - - - - -	<i>J. H. Morecroft</i>	694
WHO OWNS OUR BROADCASTING STATIONS? - - - - -	<i>Dudley Siddall</i>	706
"NOW, I HAVE FOUND . . ."		711
OUR BUSIEST DAY - - - - -	<i>Don S. Knowlton</i>	714
IN THE R. B. LAB - - - - -		717
Loss Stabilizing R. F. Circuits		
A Six-Tube Roberts Receiver		
Wire Sizes and Current-Carrying Capacity		
Laboratory Hints		
HOW TO BUILD A ONE-DIAL REFLEX RECEIVER - -	<i>John C. Davidson</i>	723
WHAT WE ARE DOING WITH BROADCASTING - - - -	<i>P. P. Eckersley</i>	731
A WINDER FOR SMALL INDUCTANCES - - - - -	<i>Allan T. Hanscom</i>	737
PROBLEMS OF RECEIVER DESIGN - - - - -	<i>Walter Van B. Roberts</i>	742
WHAT OUR READERS WRITE US - - - - -		745
THE GRID - - - - -		746
Testing the Roberts Circuit		
A Six-Tube Loop Set		
A Three-Tube R. F. A. F. Reflex Receiver		
A One-Control, One-Tube Reflex Receiver		
Jacks, and How They Are Used		
A Push-Pull Power Amplifier		
Calibration Curves		
Battery Switches for Testing Sets		
AN ANNOUNCEMENT - - - - -		752
NEW EQUIPMENT - - - - -		754
AMONG OUR AUTHORS - - - - -		756

Copyright, 1925, in the United States, Newfoundland, Great Britain, Canada, and other countries by Doubleday, Page & Co.
All rights reserved. TERMS: \$4.00 a year; single copies 35 cents.

F. N. DOUBLEDAY, *President*
ARTHUR W. PAGE, *Vice-President*

NELSON DOUBLEDAY, *Vice-President*
RUSSELL DOUBLEDAY, *Secretary*

S. A. EVERITT, *Treasurer*
JOHN J. HESSIAN, *Ass't. Treasurer*

Doubleday, Page & Co.
MAGAZINES

WORLD'S WORK
COUNTRY LIFE
GARDEN MAGAZINE & HOME BUILDER
RADIO BROADCAST
SHORT STORIES
EDUCATIONAL REVIEW
LE PETIT JOURNAL
EL ECO
THE FRONTIER

Doubleday, Page & Co.
BOOK SHOPS

NEW YORK: LORD & TAYLOR BOOK SHOP
PENNSYLVANIA TERMINAL ARCADE
LONG ISLAND TERMINAL ARCADE
38 WALL ST. AND 55 LIBERTY ST.
ST. LOUIS: 223 NORTH 8TH STREET
4914 MARYLAND AVENUE
KANSAS CITY: 920 GRAND AVENUE
TOLEDO: LASALLE & KOCH
CLEVELAND: HIGGINS CO.
NEWARK: 34 PARK PLACE

Doubleday, Page & Co.
OFFICES

GARDEN CITY, NEW YORK
NEW YORK: 120 WEST 32ND STREET
BOSTON: PARK SQUARE BUILDING
CHICAGO: PEOPLES GAS BUILDING
SANTA BARBARA, CALIFORNIA
LONDON: WM. HEINEMANN, LTD.
TORONTO: OXFORD UNIVERSITY PRESS



Radiotron
WD-11.
The ideal dry
cell tube.

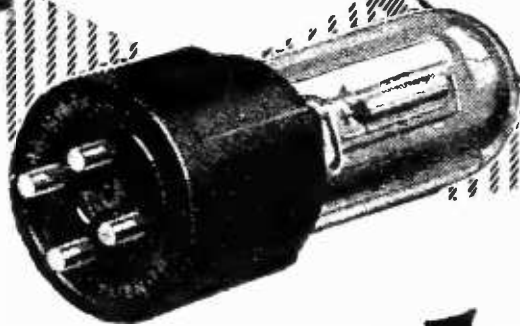

Radiotron
WD-12.
The standard
base dry cell
tube.

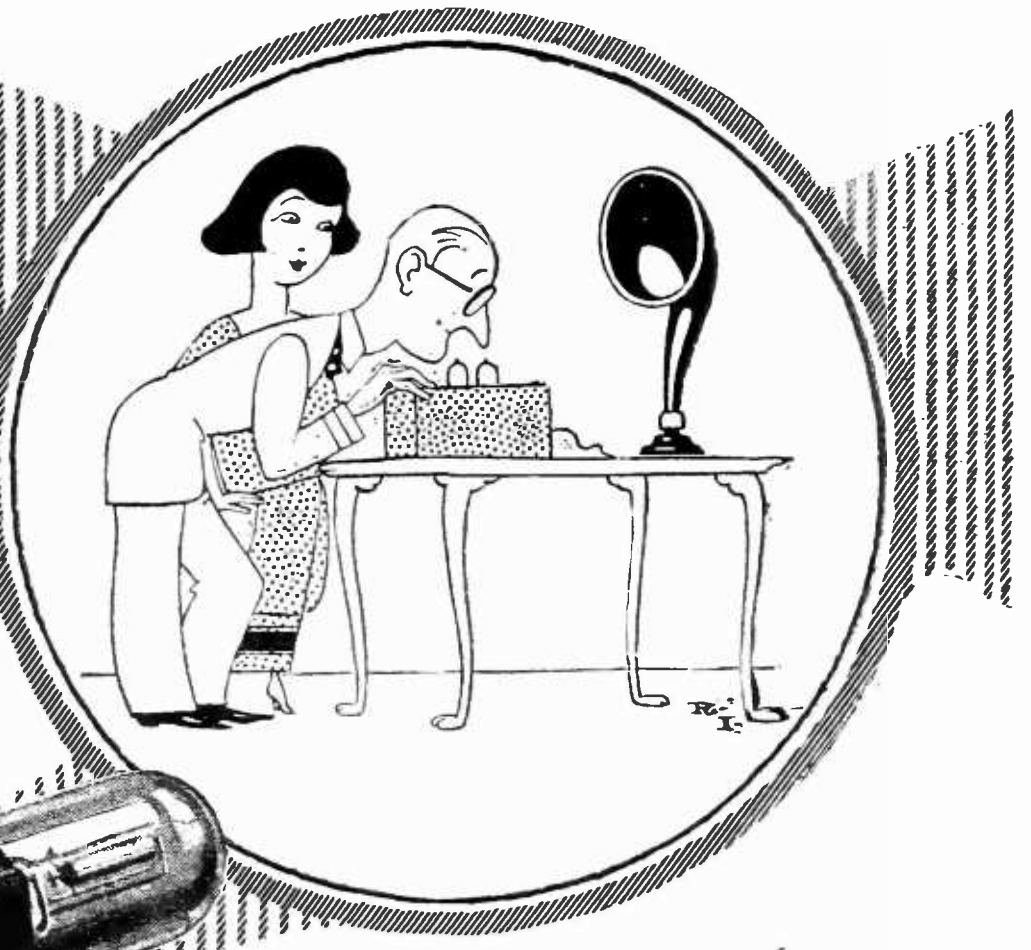

Get a good detector

Radiotrons WD-11 and WD-12 are the same tube but with different bases.

Radiotron WD-12 has a standard navy-type base. With it, you can change your set to dry battery operation. Ask your dealer today.



This symbol of
quality is your
protection

What will Radiotron WD-11 and WD-12 do as detectors? First—they are sensitive to weak signals—superlatively sensitive, as remarkable distance performances show in thousands of one-tube sets. Second, they are good “oscillators”—and that is important in regenerative circuits. And third, they are quiet in operation—add no electrical noises to the music, or speech. Radiotrons WD-11 and WD-12 are famous as audio and radio frequency amplifiers—too—and have made possible the hundreds of thousands of dry battery receivers that are in use today. They mean clear, true reception—over big distances—with dry batteries! Be sure to get a *genuine Radiotron*.

Radio Corporation of America

Sales Offices: Suite No. 32

233 Broadway, New York

10 So. La Salle St., Chicago, Ill.

28 Geary St., San Francisco, Cal.

Radiotron

REG. U. S. PAT. OFF.

★ Tested and approved by RADIO BROADCAST ★

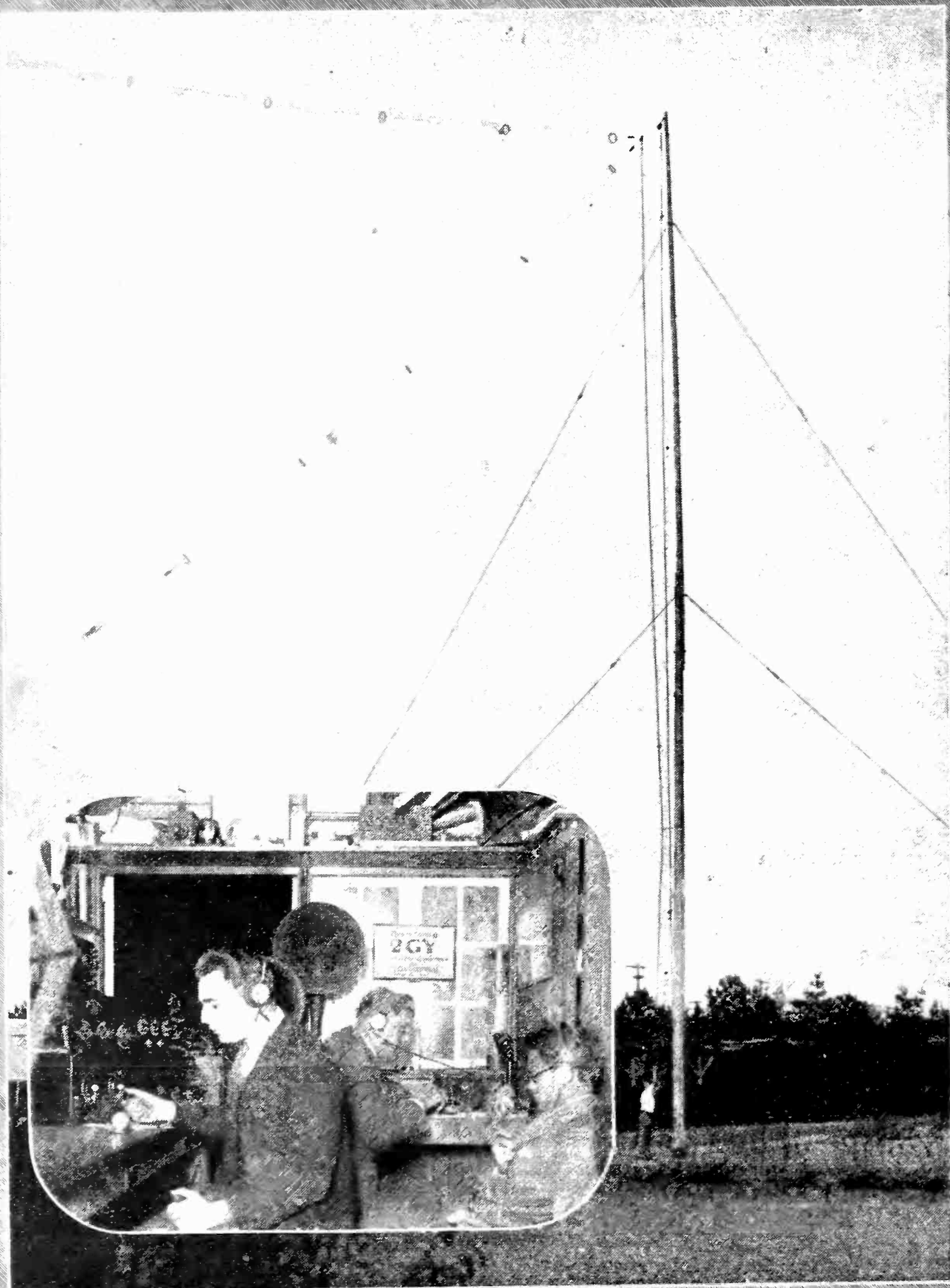

THE HUB OF THE INTERNATIONAL RADIO BROADCAST TESTS

The masts of the receiving and transmitting station at the laboratory of this magazine. Two separate cage antennas are used, one for receiving and one for transmitting. The insert shows a corner of the laboratory with John B. Brennan, Willis K. Wing, and Zeb Bouck of the editorial staff. Mr. Brennan is operating a super-heterodyne and a Knockout four-tube receiver as an alternate. Mr. Wing is operating the line which controls the wireless circuit to London, and Mr. Bouck is talking over the radio to official listening posts at Mitchel Field

RADIO BROADCAST

Vol. 6, No. 4



February, 1925

How Michael Pupin Succeeded

A Story Which Reads Almost Like a Chapter From Horatio Alger, Jr.—The History of “Immigrant to Inventor,” Whose Electrical Inventions Have Greatly Aided Radio, the Cables, and Telephony

By MYRA MAY

A STURDY, dark-haired boy, clad in a summer suit of clothes and wearing a red Turkish fez, crept close to a stack on an ocean liner during a particularly cold March crossing to America in 1874. He was a queer figure, this youngster of fifteen, minus the traditional mattress and blanket of the immigrant, with no friends or family aboard and only the warm smoke stack for company.

Yet he kept his courage, although he had only five cents in his pocket, when he landed at Castle Garden, at the Battery, New York. The genial sunshine, the activity in the harbor, the swarms of people, all thawed out his loneliness and augured that he had reached the land of opportunity. When he left the ship, he bought a prune pie from a vendor. The pie, however, proved a snare and a delusion.

It was filled with prune pits instead of the actual prunes. Having spent his entire capital, he nonchalantly strolled up Broadway.

So Michael Pupin, now professor of electromechanics at Columbia University, and widely known as the inventor of the Pupin coil, entered America.

He had run away from home. Back in Hungary, he had been known as a bright boy who had too easily absorbed the nationalistic theories of the radicals and so had been transferred from his own

local school to Prague. There, disgusted with the military spirit of the academy, he decided to run away to America. It was a sudden decision. There was no time to write home and discuss the plan, but time only to hurry to Hamburg where an immigrant ship bound for America sailed. To supplement his scanty funds, he sold his warm clothing,

“The more boys work with their apparatus, the more knowledge of the science of electricity they will obtain and the more will their interest in the marvels of radio be aroused. Radio is the coming science and if its disciples attain as much practical experience and grounding in electrical principles as is possible to crowd into their lives, they can be sure of making progress.”

—PROFESSOR PUPIN.

his books and even then, lacking sufficient money, he had to sell his heavy sheep's wool overcoat and cap to eke out his steerage fare. Then clad in the light summer suit—his sole remaining garment—plus the red fez, he came aboard.

Immigrants had to supply their own bedding. But young Michael Pupin, too poor to buy even a mattress and blanket for the hard bare floor of a third-class ship, hugged close to the smoke stack and fought off intruders. He had national traditions and five cents to bring to the new country.

Discharged from Castle Garden, Pupin looked with bewildered eyes at the clanging horse cars, at the thick network of telegraph wires overhanging the buildings, at the handsome new custom house, at the New York of 1874. Prague and Budapest had seemed bustling cities compared to his native village but the vastness of New York overshadowed even those cities.

TWO-FISTED AMERICANS

HE WAS soon accosted by a group of newsboys attracted by the novel fez. Pupin could speak no English, and the bully of the crowd, finding that he could not fight him with words, substituted fists. These Pupin understood much better. In his native Hungary, he had tended cattle and out in the open had learned wrestling from the sportive herdsman. He was lithe and strong. It was not long before he had his adversary down on the ground yelling "enough."

"I then had my first introduction to America," Professor Pupin relates. "In Europe a crowd stuck together, putting up a united front against the stranger. Over here, on my first morning, the newsboys initiated me into the fraternity of fair play. When the boys saw that I had won the fight honorably, they cheered me and when a large official in blue

suddenly appeared, they apparently interceded in my behalf, for the large official dropped his gruff tones, released my arm and even handed me my battered fez, torn and dusty from the scuffle. My adversary shook hands with me and as I swaggered back to Castle Garden the whole crowd cheered. I already liked America.

Even in far-off Hungary the fame of Franklin and Lincoln had penetrated. Now, while working on a Delaware farm—almost his first job—the immigrant boy learned the legends of Pocahontas, of the Jamestown settlement, the gallant Captain Smith, and many of the other blood-quickenings tales of pioneer America.

IN PHILADELPHIA LIKE FRANKLIN

THE lessons which I learned from my farm teacher seemed to prove that America was a great country with equal opportunities

for all if we could only take advantage of them," Professor Pupin says. "I made up my mind to find new opportunities for myself, to leave the Delaware farm and to journey to Philadelphia."

"I had compared myself to Benjamin Franklin, whose story I loved because he had been my incentive in coming to America and because he had first awakened an interest in electricity. I made my entrance into the town in the most approved Franklin manner, walking along the street eating a roll. Although I wandered five days I could find no work. I was ready for opportunity but it seemed to have passed me by. My heavy farm boots were almost worn out from hard use I had given them while I searched for a job. My ten dollars—wages I had brought from the farm—was nearly gone. As I sat in Fairmount Park and ate a big Philadelphia bun, I reflected that even Franklin with all his hardships, had been an American and had known the printing trade and all I knew was

Once in a Lifetime

The story of the success of Michael Pupin, who progressed from a poor immigrant, who landed in New York with five cents in his pocket, to a famous scientist known and respected by the entire world is one which can't be read very often. But a success such as his happens just frequently enough to assure the world that such things can happen, after all. It was not altogether by what the enthusiastic fiction writers call "sheer pluck and indomitable energy" that Pupin arrived at the position he now holds. There is a great deal of what we call ability involved. Professor Pupin, in addition to being a scientist of unquestioned standing and prominence, is personally, a tremendously good fellow, as any of his acquaintances will tell you. Miss May's story is published through arrangement with Charles Scribner's Sons, New York, who publish his autobiography, *From Immigrant to Inventor*. Many of the photographs used in this article are reproduced through the courtesy of Scribner's.

—THE EDITOR.

how to drive mules. While I moodily speculated on my difficulties, a farmer approached me and offered me a job driving mules. I accepted and once more left for the country."

But the farm was hot, the opportunities to learn English or a new trade negligible, so once more Pupin took up his wanderings. From the farm in southern Maryland, he journeyed to Baltimore and thence to New York. In those days before the Pennsylvania tunnel, trains deposited their passengers at Jersey City and a ferry took them over from there to New York. Along with the rest of the crowd, Pupin was landed in lower New York in the heart of the shipping district.

As he walked uncertainly through the unfamiliar neighborhood, he saw a small hotel with a German name. It was an oasis in a region of strange sights and sounds. The proprietor had a son about Pupin's own age and the two became friends immediately.

Pupin's funds were so limited that the two boys decided their first consideration must be to get him a job. This, however, was no easy matter. During the previous year the entire country had suffered from the great panic of 1873. This was the summer of 1874, but the

country was not yet settled again. There was widespread unemployment. No matter how early the two boys went in response to advertisements for labor, they were sure to find long lines ahead of them. In those gloomy days men were so desperate they waited all night at the newspaper offices so that they could read the "help wanted" inserts in the first editions and stand all night in line to apply for work the next morning.

Pupin and Christian, the son of the hotel keeper, soon discovered that the erstwhile farmhand would never get a job in this way. More drastic methods were necessary in a neighborhood so close to the shipping center. The opportunity finally presented itself. During a strike of longshoremen, Christian, who acted as Pupin's business manager, signed up his client as a scab.

"My job was to help the sailors paint the ship," Professor Pupin remembers. "Partly as a means of protecting us from the strikers and partly as a means of getting the work done quickly, we substitute workers were out in the bay. Of course, I knew nothing about painting but bitter need for employment will give us ability to do almost anything. At the end



CASTLE GARDEN, NEW YORK

Where Pupin landed from the German immigrant ship in 1874. Castle Garden has since been converted into the Aquarium and immigrants no longer land there, but down the Bay at Ellis Island.

of three weeks, when I returned to the little German hotel and my friend, I was a full-fledged painter with thirty dollars, which was more money than I had ever earned before.

My new found work was short-lived. Christian left town for a Western city and I, with my best friend gone, was no longer interested in the German hotel. I rented a small room near Cooper Union, in an entirely different part of New York.

WHERE HIS STUDY REALLY BEGAN

THEN I started hunting work as a painter. Conditions were hopeless; more than a year had passed since the great panic, and labor was still a drug on the market. I tramped the streets from early morning until the last shop closed, but I could not find employment. My little hall bed room was so unfriendly that I formed the habit of spending my evenings at Cooper Union. Here I first read of the mysteries of science and tried to reason out the phenomena of sound and light.

"After I had hunted work in vain for several weeks I finally created a job for myself. I

followed coal wagons and when the coal was dumped in front of its destination, I would offer to put the coal in the cellar for fifty cents a ton. It was back-breaking work. I frequently toiled two days to make a half a dollar. But when it was over, I could buy a bowl of filling bean soup and a chunk of brown bread for five cents at the Bowery Mission, so I never starved.

"When the coal was in the cellar I would suggest that I paint the walls and ceiling of the basement. My story of being a journeyman painter out of work and forced to carry coal for fifty cents a ton was so heartrending that owners were often glad to help me by giving me painting jobs. Carrying coal and refurbishing damp, dismal cellars were not cheerful occupations for the winter, you will admit."

In the spring, Pupin paid a return visit to the German hotel keeper. He was full of sympathy for the unfortunate immigrant and promised to get him a steady job. Within a few days he had made good his word. Pupin had a position in a cracker factory, working with a squad of boys punching the name of



PUPIN'S BIRTHPLACE

In Idvor, in Banat, Hungary. The house is the first on the left. Pupin left his native Hungary in 1874 to come to this country where he landed with scarcely a cent in his pocket

the company on sweet biscuits. It was not the mechanical act of pressing the name on the crackers that interested him, for that merely required a certain manual dexterity. It was the boiler room in the factory that fascinated seventeen-year-old Pupin.

Early in the morning, before the factory whistle blew, he was shoveling coal, watching the fires, and learning engineering from the fireman. There, in the boiler room, he had his first lessons in engineering. He was puzzling over the phenomena of light and sound, but the boiler-room professor could not shed much light on his difficulties.

A BOILER SHOP SCHOOL

THIS improvised school, with its science department in the basement, had a classical course which was given on the top floor. In a philanthropic attempt to utilize some waste space to the advantage of the workers, the company had made sleeping accommodations in the attic of the factory. Pupin, a homeless waif, lived in this make-shift dormitory. One of his roommates was a crippled German student with a remarkable knowledge of Greek and Latin, a veneration for ancient civilization, and a contempt for modern industrialism. He instilled in Pupin a love for the classics. At the close of the factory day the two machine workers forgot their manual labor during the long mill hours, and recited Latin prose and reveled in the sound of Greek verse.

Naturally under these circumstances, Pupin longed for more education. He had no money to pay for college tuition. But a boy who had taught himself the ways of a new land could find the means to get further education. He did. The factory was his high school. For a science laboratory, he used the boiler room and for his classical subjects, he had an expert tutor in the German scholar. In his Columbia College entrance examinations he did so brilliantly that he was given a scholarship for the entire four years.

College over, Pupin was offered his choice of a fellowship in either literature or science. His record in both departments had been equally high, but he chose the science.

"When I was a little sheep herder in the old country," Professor Pupin confides, "we used to warn each other about straying cattle by means of signals which we sent by tapping on a knife stuck deep in the hard ground. I had observed that the sound was carried for greater distance through the hard ground than through the air. I could not understand why. It was a problem that fascinated me so that when I had the chance to continue my studies, I selected science in the hope that it might answer my question."

In Europe, Professor Pupin worked at Cambridge and then studied for a doctor's degree at Berlin. Meantime Columbia University, his alma mater, had organized a department of electrical engineering in the school of mines. When Pupin heard of it, he applied for the position. Needless to say a student who had made his brilliant college record, who had won scholarships in Europe, was promptly given the post at Columbia.

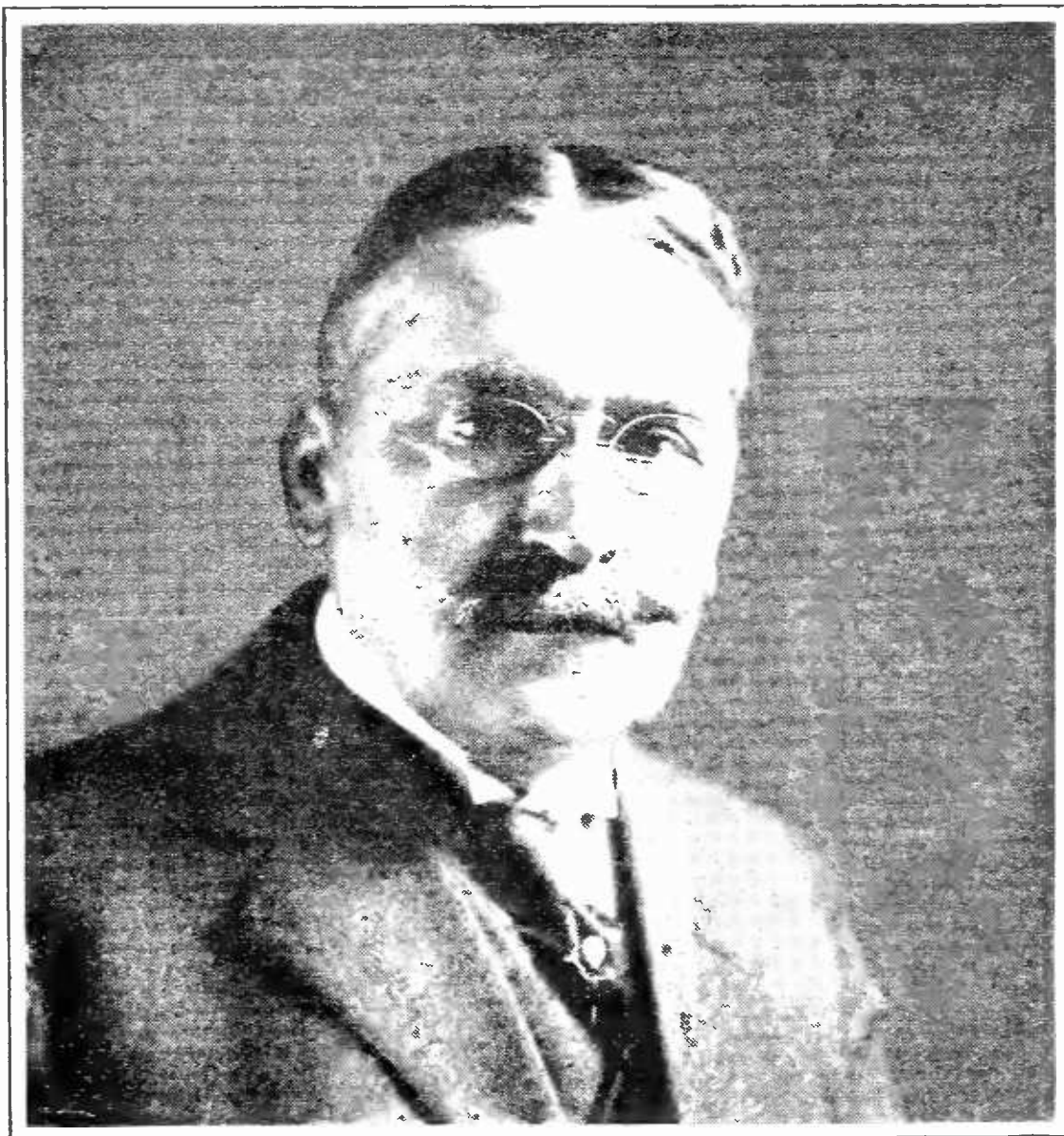

© Underwood & Underwood

A RECENT PHOTOGRAPH

Of Professor Pupin, who now holds the chair of mathematical physics at Columbia University

A PROFESSOR AT COLUMBIA

THE physical equipment of the new department was primitive. There was only a temporary shed, a "cowshed" the students called it, with a laboratory equipment of a dynamo, a motor, and an alternator. It seemed a hopeless prospect to the young teacher fresh from the marvels of European science but his enthusiasm was such as to conquer all difficulties.

"From my studies of the experiments of the European physicists, I concluded that sound, like light, traveled by the vibrations being carried from one wave to the other, reinforced by each wavelength. I believed that by shortening the length of the wave, the sound could be carried further and on this basis I perfected my induction coil. By using three or four coils to the mile on a long-distance telephone wire, the size of the wire could be considerably reduced. Not long ago, a friend of mine, a telephone executive, figured that my invention had saved the telephone company about a hundred million dollars and went on to say that without it long-distance communication could never have been greater than about twelve miles."

Professor Pupin has not only cradled the art of long-distance telephonic communication but he is responsible for six out of the nine basic radio inventions. In 1895-6, while he was an assistant professor at Columbia and working in the derided "cowshed" laboratory, he evolved an apparatus for electrical tuning and rectification, and in 1902 he sold his patents to the Marconi Company. This fact is not generally remembered.

Professor Pupin, fresh from his European studies, had become much interested in the theories of Hertz, the father of radio, and had begun experimenting with them. At that time, the rectification electrical transmission of sound was not known, the waves brought an indistinguishable buzz which Professor Pupin

hoped to make audible. After a year's experimenting, he succeeded.

Sounds which the waves brought could now be understood. But the growth of radio had only just begun. Professor Pupin, who nurtured radio in its infancy, brought it still another step forward. He suggested modifications which transformed these explosive electrical motions into more or less damped oscillations.

All of us know to-day that when our receiver is not in resonance with some particular transmitter,

we simply turn a knob to get the desired wavelength. But in the 1890's tuning wasn't so simple. In fact, troublesome wavelengths were one of the biggest drawbacks to the science. Professor Pupin undertook to correct this deficiency. Through exhaustive experiments, he devised an apparatus which superimposed these waves and got them in phase.

"The electrical tuning at the receiving end, as we know it, came into use when

Marconi took over my invention of electrical tuning," Professor Pupin explains. "Selectivity was thus introduced into wireless reception and it eliminated some of the objections to the new form of electrical communication. Rectification of the received electrical oscillations by crystals of asymmetrical conductivity, or by my balanced electrolytic rectifier was the next advance."

A TEACHER OF FAMOUS MEN

AS A teacher, Professor Pupin has started many of our most famous radio figures on their triumphant way. At one time three boys were working under him for their doctor's degrees. They were E. H. Armstrong, J. H. Morecroft, now of Columbia University, and Alfred N. Goldsmith of the College of the City of New York. It was in Professor Pupin's laboratory at Columbia that Armstrong successfully developed his feed back circuits. It was in Professor Pupin's laboratory



PROF. M. I. PUPIN
In 1883 when he graduated
from Columbia University

that Robert Andrew Millikan began his scientific career.

Pupin, this famous teacher of famous men, exhorts boys everywhere to "monkey with their sets."

"The more boys work with their apparatus, the more knowledge of the science of electricity they will obtain, and the more will their interest in the marvels of radio be aroused," he says. "Radio is the coming science, and if its disciples attain as much practical experience and grounding in electrical principles as is possible to crowd into their lives, they can be sure of making progress."

During the war, Professor Pupin did research work for the United States Government

in radio communication. His results became government secrets and outside of the fact that his war activities necessitated many trips to Key West, the world knows nothing of his work. As a product of his activity at this time, he helped organize the third arm of our national defence—the National Research Council, an organization of scientific men with headquarters in Washington.

The story of America contains many epics of boys who, beginning at the bottom, struggled to the top, but none illustrates more clearly than this one the chances for a penniless, working boy to achieve a technical education and to become a power in the scientific world.



THE CHURCH

Where Pupin worshipped as a young boy in Idvor

The Way of the Transgressor

A Word About Common Deceptions in the Sale of Tubes, Batteries, Antennas, and Complete Sets—Some Guides for the Tyro Wandering in the Radio Forest

BY WILLIAM P. GREEN

Associate Director of the National Vigilance Committee, Associated Advertising Clubs of the World.

PROBABLY the most outstanding instance of outright fraud in radio today, is found in the manufacture and sale of counterfeit tubes, both in tube construction and in fake labels and cartons. The counterfeiting at times would almost baffle an expert.

In some instances former employees of large electrical manufacturing concerns which hold tube patents are ferreted out as members of these counterfeiting rings. They hold forth in secluded spots, sometimes in the rear of a garage or perhaps in a private residence. No signs are in evidence to indicate what is being done on the premises. Frequently the blinds are drawn. In many cases investigators have found it difficult to secure entrance at all, visitors being required to state their business in a front hallway or even out on the sidewalk. As many as eight hundred tubes a day have been manufactured in one of these places alone.

Recently a complaint was made to the National Vigilance Committee that a concern in a middle western city was selling tubes represented to be genuine Radio Corporation of America products, under circumstances that appeared suspicious. Tubes were purchased at the store and forwarded east for examination. This examination showed that the grid, plate, and the glass bulbs were not genuine R. C. A. products. The bases were the genuine article. The use

of the base in this way made it possible for the tubes to be sold with every appearance of being a genuine Radio Corporation product.

Occasionally the practice of buying up worn out tubes of standard make, in order to secure the bases, is discovered. Add to the base a counterfeit filament and other essential parts and the finished product has all the appearance of the genuine article. Even the identification mark, such as the well known General Electric circle frequently is counterfeited. The counterfeiting of the cartons and the directions accompanying standard make tubes usually is accomplished by means of the ordinary photographic plate process.

One manufacturer of counterfeit tubes may sell to many distributors. As a general rule the distributor knows what he is buying and when questioned about the tubes he is marketing, he refuses to disclose the source of supply.

The manufacture of counterfeit tubes is, of course, outright fraud. It is not to be classed with many other forms of deception and trickery that put in an appearance.

REPAIRED TUBES

THIS counterfeiting of tubes is one of the handicaps in radio to the removal of which manufacturers and retailers are devoting much attention.

Some concerns advertise that they will repair radio tubes and this raises the interesting point of whether the tube actually is repaired

Truth in Advertising

Is the splendid slogan of the Associated Advertising Clubs of the World, and this forms the second of a series of excellent articles by Mr. Green, an official of that organization, on common deceptions in radio merchandising and advertising, all of which are violations of faith, whether the deceptions are committed intentionally or otherwise. The first of Mr. Green's articles appeared in RADIO BROADCAST for August, 1924, and discussed fraudulent practices in selling complete radio receivers. The Better Business Commission, which is now organized in 36 cities in the United States, has also in some cities taken steps to insure that radio dealers abide strictly by the highest code of professional ethics in their advertising and merchandising. Neither this magazine nor Mr. Green wish to give the impression that the radio business is full of irresponsible and conniving dealers. That there are not more dealers whose methods are not above reproach is remarkable, considering their now large numbers. Every one who buys radio apparatus should be interested in what Mr. Green has to say.—THE EDITOR.

or a new tube constructed on the old base. This question is closely concerned with the patent rights of the leading manufacturers of tubes.

There is one Federal decision which holds in effect, that the replacement of a vital part is a violation of patent rights.

Most certainly the filament of a vacuum tube is the vital element of the product (said an official of the Radio Corporation of America in discussing this question). It is the part that emits the electrons, producing the actual phenomenon of detection or amplification. There is no substitute that can be used for this filament. If it is omitted, no results whatever will be obtained. In most so called repair work, the replacing of the filament is not the only thing that is done. A new vacuum must be obtained to permit the electrons to pass from the filament to the plate. The tube, therefore, must be evacuated anew

and, as a matter of fact, it costs almost as much to repair certain tubes on a commercial scale as it does to make a brand new product.

This question of tube manufacture and repair still is fraught with some uncertainty. The chief interest of the consumer is in the question of whether tubes are genuine or counterfeit, actually repaired or completely rebuilt, and, in any case, whether the result, as determined by actual use, is in accord with the representations made by the advertiser. The average consumer is not much interested in patent rights or infringements. What he wants to know is whether the merchandise he buys is what it is represented to be, in name, quality, and utility.

Still other conditions which vitally affect the public are coming in for consideration.

Perhaps the most interesting of these is the cut price situation. Some retailers, as a steady policy, offer sets at prices on which the manufacturers claim the retailer cannot possibly make a profit. These manufacturers do not claim that the merchandise is not always

genuine or that it is defective, although many purchases have been traced where such was the case. Their chief contention is that in some instances cut price merchandise is offered as a leader in order to bring the customer into the store as prey for the sale of other inferior goods. Undoubtedly it is true that radio offers a fertile field for certain types of "bait advertising" because of the number of accessories needed with a set. In many cases the total cost of such accessories equals or exceeds the cost of the set itself.

The source of supply of cut price merchandise is a constant problem with the radio manufacturer. Much of this cut price merchandise is secured through indirect channels. The retailer asks some friend in a distant city, who happens to be in good standing with the distributor, to order certain goods which, when received, are relayed to the retailer desiring them. Another source of supply is the overstocked retailer who, when a representative of a cut price store appears on the scene, is glad to unload at a price approximating the manufacturer's.

One retailer, whose chain of radio stores features cut price merchandise, maintains that the radio manufacturer's profits are in proportion to his sales and that the retail price is not a factor in his profits at all.



L. E. HOLLAND

Who is serving his third term as president of the Associated Advertising Clubs of the World. Himself an ardent radio enthusiast, Mr. Holland has been keenly interested from the beginning in the protection of the radio industry and the public from deceptive merchandising and advertising practices

DOWN WITH THE ROOF WIRES

Regardless of the type of tube set you operate, this indoor aerial will equal, and in many cases exceed, any outdoor aerial you may be using.

MORE THAN A SHADOW OF DOUBT

Extravagant claims, which in many instances, actual trial shows to be unjustified, breed certain dissatisfaction and tend to impair the enthusiasm of radio purchasers. The radio public itself should cooperate to require advertisers to tell the truth about their products

"If the manufacturer maintains a sentimental attitude as to how his goods shall be priced by the retailer," he argues, "let him total his cash book at the end of the year and he will find that the radio chain store quite probably has moved one hundred times as much merchandise as the collection of small jobbers."

Careful reading of magazines and newspapers continues to disclose practices which bear out the statement that radio is passing through a period in which the buying public must exercise great caution and discrimination. Take as an illustration a recent advertisement of a well known battery by a retail store. It read—

**We are the only dealer in
the city in a position to supply
the public with unlimited
quantities of this**

NEW

108 volt B battery

The fact was that this battery, instead of being a new model, was being discontinued. The agency handling the advertising copy explained that the word "new" was intended to mean that the batteries were fresh from the factory and that "unlimited" meant that enough were available to supply the store's trade. Certainly the word "new" in the copy was objectionable because the average reader might well take the advertisement to mean that the manufacturer was bringing out a new model.

THE OVER-ENTHUSIASTIC ADVERTISER

NOW and then advertisers inadvertently get off on the wrong foot. Around the time of the national political conventions, an eastern manufacturer of radio sets advertised in newspapers on the Pacific Coast, urging the public to buy his product in time to listen in. Investigation developed that Kansas City was the nearest point from which the conventions were being broadcast and the feat of reaching that far east from the west coast during the day time, when range of reception is very limited, was anything but a certainty. Again we have the manufacturer of a well known loud speaker, whose advertising in the middle west emphasized the pleasure to be derived from listening in on New York grand opera. It is well known that the Metropolitan company is not heard over the air.

Another case in point is the loose statements made about "noisy batteries." One radio expert to whom the writer talked recently stated that such noise practically never occurs in batteries used for filament supply but that it sometimes is found in plate batteries. The cause is either a defective cell in the battery, or a loose connection between the cells. Almost any dry cell, he pointed out, even those of the most reliable makes, may develop noise when they are nearly used up.

Other extravagant claims are made concerning the life of batteries. This is a difficult factor to determine, and it is here that batteries of different manufacture may be expected to vary materially if at all. Only usage can determine the real utility and life of any particular battery with consideration, of course, for proper care. This is all the more reason why purchasers of radio equipment should give real consideration to the makes and types of batteries they purchase for their sets in order that they may have the maximum protection on the money expended.

Claims for new and startling discoveries in the battery field likewise should be carefully examined. Years of study have brought them to their present point of efficiency and most of the possible improvements could hardly be called revolutionary.

Within the last year one concern has advertised that its batteries will enable the operator of a radio set in the middle west to hear England or South America as clearly as Detroit or Chicago. The advertising copy was so worded as to make it appear that whatever troubles are encountered with a set may be removed by substituting the batteries ad-

vertised for those in use. This is obviously absurd.

Another type of advertising into which the public should inquire carefully before purchasing the goods advertised is that offering various indoor aerials either of the loop or single wire type. Representations that such aerials will equal or outdo the results obtained with an outdoor aerial, regardless of the type of set used, are not always justified, as shown by actual experience in certain locations and under varying conditions. Results obtained at close range may not be possible at all over long distances and it would be well for purchasers to have a very definite understanding that the merchandise may be returned if it does not live up to the claims made for it.

Then again, we often hear mathematics spoken of as an exact science. One might reasonably conclude from this that statements in radio advertising that are based on mathematical calculation could be taken without the proverbial grain of salt. That such is not always the case, however, was demonstrated recently when a well known radio store advertised a standard make receiver at half price, with the added attractive offer that with each purchase an extra piece of apparatus, designed to increase signal strength, selectivity and to improve tone quality, would be given *free*.

Price figures were set out in detail, as illustrated in the following:

List price of receiver	\$150.00
List price of extra unit	25.00

Now if the receiver were being sold at half price, and the extra unit given free with each purchase, the customer would have to put on the counter only \$75. to be entitled to the complete outfit. On the contrary, however, the price quoted was \$87.50. Either the receiver was not being sold at half price or the extra piece of apparatus was not being given free to each purchaser of a set. The advertising agency explained the discrepancy by saying that a mistake had been made in the figures.

BUY CAREFULLY

RADIO BROADCAST, through its columns, is endeavoring to inform the public concerning practices by reason of which purchasers of sets and accessories should shop carefully. The National Vigilance Committee of the Associated Advertising Clubs of the World recently prepared a resumé of practices which may be useful to the radio public in reading radio ad-

vertising and in making purchases on the strength of it. This resumé is as follows:

- 1.—Appropriation of radio tube type numbers, or any substantial or material part thereof, such numbers having been originated by and become identified with the products of certain well-known manufacturers is a form of unfair competition. Illustrations of such original type numbers are "WD-12", "UV-199" and "201-A" as applied to the tubes of the Radio Corporation of America, and "DV-2" as applied to the tubes manufactured by the De Forest Radio Telephone and Telegraph Company. Tubes manufactured by any other companies should be advertised and sold under their own original and distinctive identification marks.
- 2.—Sets built by retail stores and containing certain licensed parts bearing the names of well-known manufacturers of sets using the same circuits, should be advertised and sold in such a way as to make it perfectly clear to the public that they are store built rather than factory built. Neutrodyne sets are a case in point.
- 3.—When a concern seeks to advertise any type of radio product concerning which there is reason to believe that the patent or license rights do not permit the manufacture or sale of the product, the concern should be required to make a reasonable showing that it is within its legal rights and entitled to market the merchandise.
- 4.—Claims for radio apparatus, such as distance reception, should in most cases be based on average performance rather than some rare, exceptional feat. If the exceptional instance is featured, the advertis-

SPECIAL OFFER
FOR TODAY ONLY
THE SENSATIONAL COLUMBIA
REFLEX
At the Unheard-of Price of
\$79.50

DOES THIS MEAN WHAT IT SAYS?

In going to a store in response to an advertisement like this, it is important to observe whether or not the retailer has on hand a sufficient number of these sets to fill a reasonably popular demand. Often only one set, advertised as the sample ad above shows, are being offered as bait to get the public into the store. The customer should be careful to see that the accessories he buys with the set are genuine and recognized by the trade as efficient products



WHICH IS GENUINE?

The only distinguishing mark between the two tube cartons cannot be detected in the photograph. The carton on the right is genuine and the one on the left is counterfeit. The tube which came in the counterfeit container was counterfeit. The color of ink on the genuine container was a deeper red than the false one

ing copy should make clear the fact that the same result is not to be expected in average day to day performance. Much disappointment and dissatisfaction may be avoided if radio novices are given some information in advance that atmospheric disturbances, seasons, and other conditions affect radio reception.

- 5.—Merchandise advertised as being reduced from a certain list price and represented as possessing the list price value, should carry all of the advantages, such as factory guarantees and repair privileges, to which any purchaser who buys at the regular list price is entitled. Otherwise the customer is not getting the complete service or value that is included in the regular list price quoted in the advertisement.
- 6.—Advertising of radio sets should state what accessories, if any, are included at the price quoted, and if accessories are not included, this should be apparent from the wording and arrangement of the advertising copy.
- 7.—Claims as to batteries and other accessories should accord with such limitations of

performance as recognized scientific opinion in the industry has determined that the purchaser may reasonably expect from a particular type of product. Guarantees, refunds and other sales appeals should be free from the ambiguity or tricks that sometimes make them the source of current dissatisfaction and a future distrust of advertising.

- 8.—When a set is advertised at a reduced price after the model has been discontinued by the factory, it should not be represented as still possessing its regular list price in a way that leads the public to believe that it is securing a much better current value than actually is the case.

- 9.—When any particular piece of radio merchandise is featured through advertising as a leader, the concern should be required to have a sufficient supply on hand to fill a reasonable public demand.

- 10.—Claims for the efficiency of indoor aerials, as compared with outdoor ones should be made with due consideration of the types of radio sets to be operated, distances from broadcasting stations, location of the aerial or loop in the buildings where used, etc.

- 11.—Advertising of radio devices to reduce station interference should not infer that any number of broadcasters may be eliminated at one time, when such is not the case. Claims of the perfect operation of such devices should be made with due regard for usage under exacting conditions, in that such merchandise usually is purchased by reason of unfavorable location, or out of date receiving apparatus, etc.

- 12.—In advertising radio accessories, such as dry batteries, which show certain shelf depreciation over a period of time, use of the word "new" should carry with it a clear indication of whether reference is being made to a new model of the article involved, or merely to the receipt of new stock fresh from the factory.

What Reflex Means

How One Tube is Made to Do the Work of Two—Problems of Reflexing and How They Are Solved—Various Uses of Reflexing—Another Family Tree Diagram

BY JULIAN KAY

THIS article in this series of informative articles about some of the technical phases of radio written in a decidedly non-technical fashion deals this month with the use of reflexing. The patent on the reflex system dates back to February, 1913, when Schloemilch and Van Bronck had their application approved. There are few who have heard something about radio who haven't also heard the word "reflex." Many radio listeners want a good review of reflexing and that is just what Mr. Kay has done. Other articles in Mr. Kay's "What's In a Name?" series have discussed the various classes of receivers in use, radio-frequency amplification, audio-frequency amplification, and the super-heterodyne.—THE EDITOR.

THE old song that "every little bit added to what you've got makes just a little bit more" applies nowhere in radio quite so well as in this reflex business. Given a small pocket book and a long way to go via radio, what is one to do? The answer is to add just the little bit more—and that is what reflexing effectually does.

In the preceding articles of this series, the various forms of detectors and amplifiers have been analyzed as separate units. Some mention has been made of complete receiving equipment such as the neutrodyne and the heterodyne, both of which are really efficient combinations both of detectors and amplifiers. It is in the latter class of complete receivers that the reflex lies.

The Family Tree diagram on page 672 shows the place of the reflex among radio circuits. It is a combination, a sort of trick combination if you will, of a detector and two amplifiers. The reflex idea may be extended to other complete receiving systems, such as to the neutrodyne, for example in the Fada 160, or to the super-heterodyne as in the Radiola.

The main idea of reflexing is to do away with one vacuum tube, to make one do the work of two. And while it is fairly simple to build a detector and an amplifier as separate units, it is a more difficult problem to build a reflex that works as well as the more complicated apparatus it replaces. Unless the reflex is correctly constructed from tried and true methods it will lose as much or more than it gains—a state of affairs that is not true economy.

Fig. 1 shows the general scheme. Energy from the output of the circuit is fed back into the input so that the apparatus involved does double duty. The necessity for the frequency changer lies in the fact that one cannot perform this feeding back stunt without having something happen—a something usually made evident by howls and groans. In other words, the amplifier oscillates.

A SIMPLE FORM OF REFLEX

A SIMPLE form of reflex with which everyone is familiar is the well known "tickler" feed back affair. In this case, shown in Fig. 2, some of the radio frequency energy is placed in the input again by means of a coil inserted in the output or plate circuit. If the tickler is brought near enough to the secondary coil, the system oscillates. The remarkable amplification that results just before oscillation takes place is well known.

If the same scheme could be applied to audio-frequency amplifiers, much more amplification

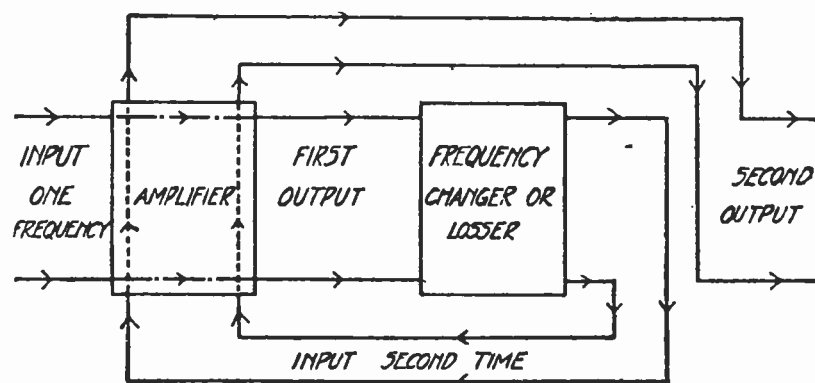
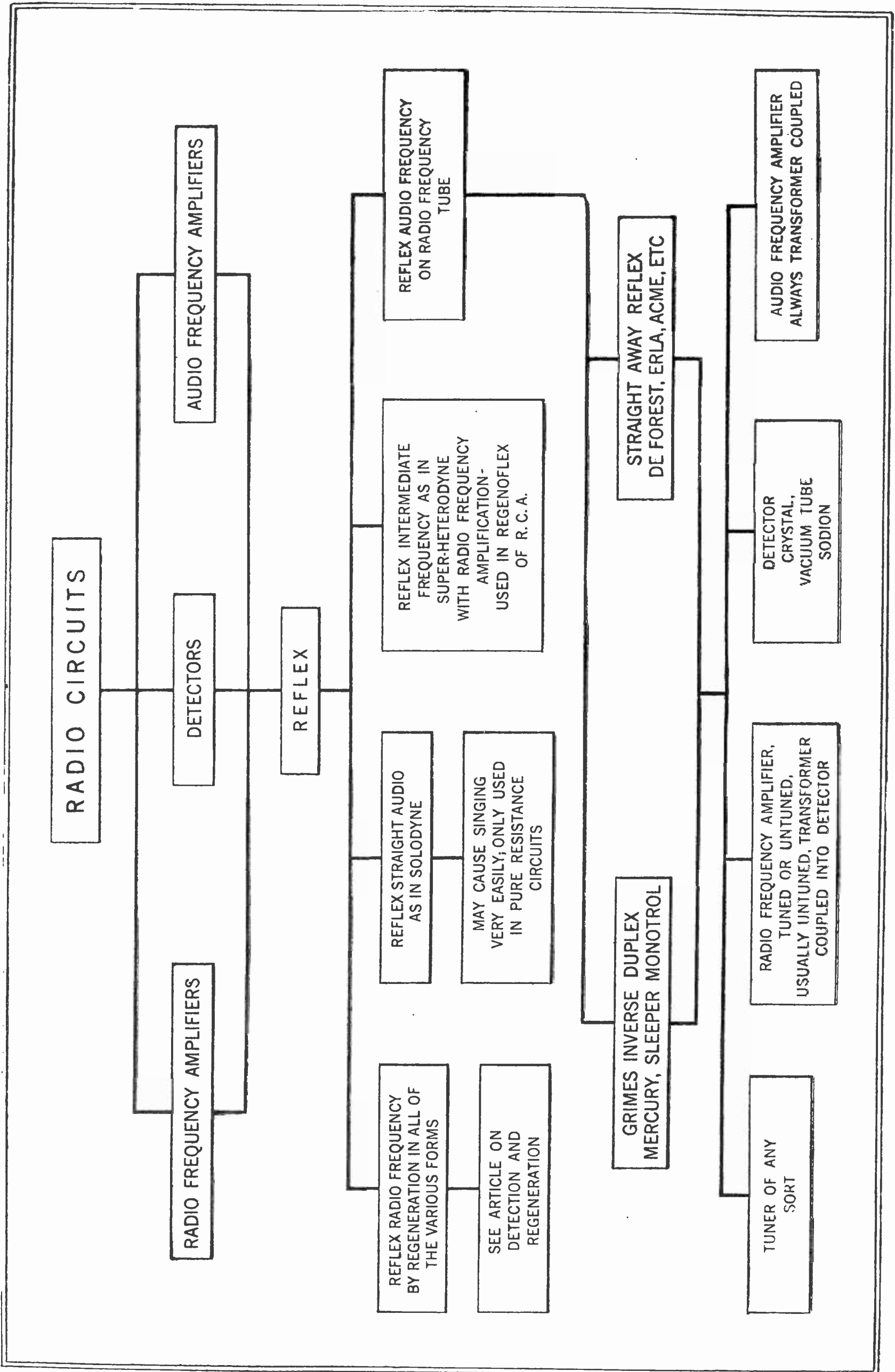

FIG. 1

The reflex idea. The main idea in all reflex circuits is to make one tube do the work of two



THE FAMILY TREE FOR REFLEX CIRCUITS

might be expected. Here, however, we are dealing with a different problem. In the tickler case we are interested in a very small percentage of the total frequency, that of the incoming signals, say one million cycles. The tuning is so adjusted and the position of the

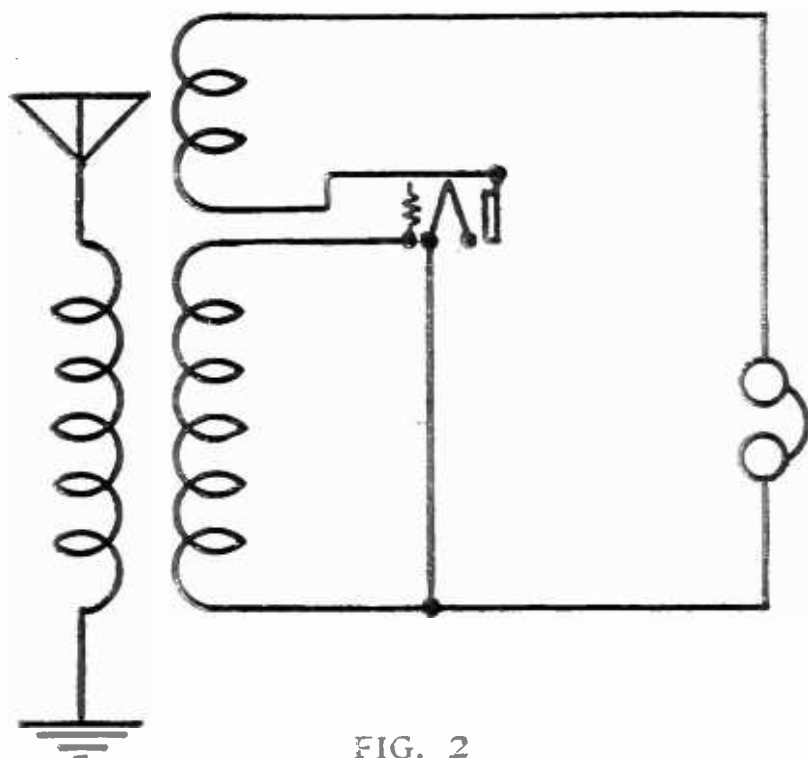

FIG. 2

One of the simplest forms of reflex and one of the best known. The coil in the plate circuit is known to all users of regenerative sets. Some of the radio frequency energy is fed back again through the tickler coil to the primary circuit

tickler so arranged that oscillations over this comparatively narrow band can be controlled.

In audio-frequency amplifiers, however, we are interested in the uniform amplification of the whole band of frequencies from fifty to several thousand cycles. If the tickler were adjusted for one particular frequency, oscillations would probably occur at another. For code reception where all signals can be brought to a single audible note, say 1000 cycles, the audio amplifier may be made to regenerate in this fashion with remarkable results.

In the case of the resistance-coupled amplifier, as illustrated in Fig. 3, part of the output energy of one tube is sent around the circuit again. There are certain precautions that

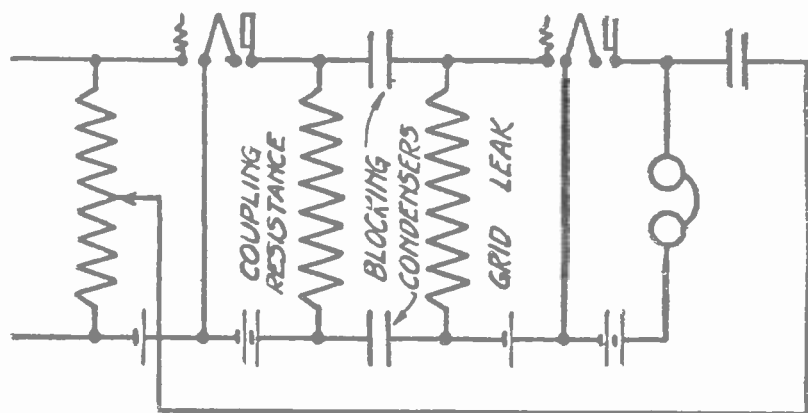

FIG. 3

Reflexing in a resistance-coupled audio-frequency amplifier

must be taken before such a scheme works, precautions with what the engineer would call the "phase relations." In general such feedback is undesirable because of the difficulty in controlling the system.

WHEN AMPLIFIERS OSCILLATE

AUDIO-FREQUENCY amplifiers very frequently do oscillate, a result of some undesirable coupling between the output and the input. A high pitched squeal may betray this state of affairs, but often the oscillations take place at a frequency above audibility. Lack of amplification and some distortion is the result. It is for this reason that all grid and plate leads in multi-stage amplifiers should be as short and as far apart as possible.

In practice, then, a frequency changer follows the amplifier that is to be reflexed and it is the greatly changed frequencies that are returned to a preceding part of the circuit to go the rounds again. Fig. 4 shows the general principle. Incoming signals are sent through a radio-frequency amplifier where they are boosted in amplitude. They are then changed

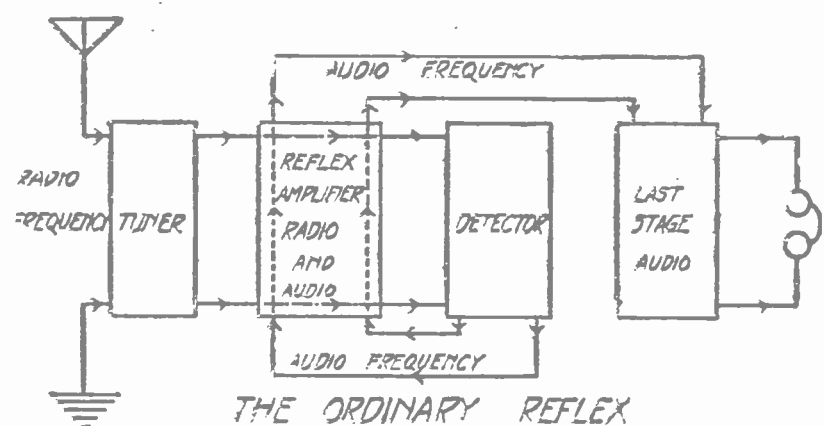

FIG. 4

A schematic diagram of the application of the reflex principle to a common type of circuit. The paths of the various frequencies are made quite clear by the arrows

in frequency by the detector and are sent back to the first amplifier. This first tube, as in the Roberts Knockout circuit, has currents of two widely different frequencies flowing through it—so widely different that no interaction occurs. For instance at 300 meters the incoming signals have a frequency of around one million cycles, at least one hundred times greater than any audio-frequency tone that will be amplified.

The detector may be any one of the various forms. Quite often a crystal is used, although louder signals will result from using a tube detector. The crystal is somewhat tricky in adjustment, a fact that has some bearing on the tuning and upon the quality of signals, as will be explained later.

The advantage of the reflex trick is obvious. With two tubes, one used as a detector and the other functioning as both radio- and audio-frequency amplifier, we get results equal to that when three tubes are used. This reduces the first cost of the set by one third and at the same time decreases the space required as well as materially lessening the battery upkeep.

REFLEXED SUPER-HETERODYNE

ONE of the best examples of reflexing is that performed on the super-heterodyne. Fig. 5 shows how the idea is applied. Following the first amplifiers, the frequencies are materially reduced by means of a detector and are then fed back into the amplifier whence they go to other intermediate-frequency amplifiers. Another stage of reflex might be applied as the dotted lines show, but the trouble from oscillations and from overloading probably would not warrant this decrease in tubes.

THE INVERSE DUPLEX

THE Inverse Duplex credited to Grimes is a good example of a complicated reflex, as shown in Fig. 6. In this case radio signals are amplified twice. Then the detector output of low frequency is fed back into the second radio amplifier, thence into the first radio amplifier and finally into an audio stage all its

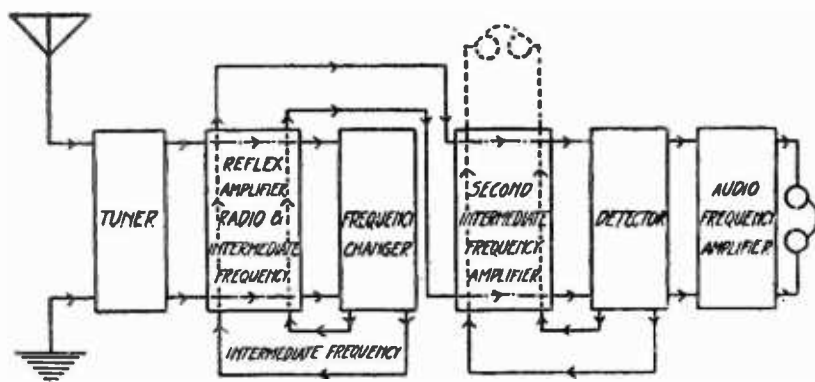

FIG. 5

A schematic diagram of the Radio Corporation reflexed super-heterodyne. Some very delicate and rather difficult technical problems are involved in making a circuit of this sort commercially practicable, but it was done by Messrs. Armstrong and Houck of the Radio Corporation

own. The "inverse" idea comes from the fact that the second stage of radio is the first stage of audio, and the first stage of radio is the second of audio—just try and figure that out!

Other reflexes are shown on the Family Tree diagram and do not differ materially from those described.

REFLEX TROUBLES

THE only advantages in the use of reflexing lie in the economy of apparatus and space effected. Electrically there is no advantage in

performing three operations in two tubes in place of three. In fact, unless considerable care is taken, there are several disadvantages. For the fan, however, who is cramped for funds, who wants to get "just a little bit more" out of his apparatus, the reflex is the thing. RADIO BROADCAST has taken considerable pains to perfect the Roberts circuit which works and works remarkably well. By following the detailed directions that have been given for its construction, any one can have

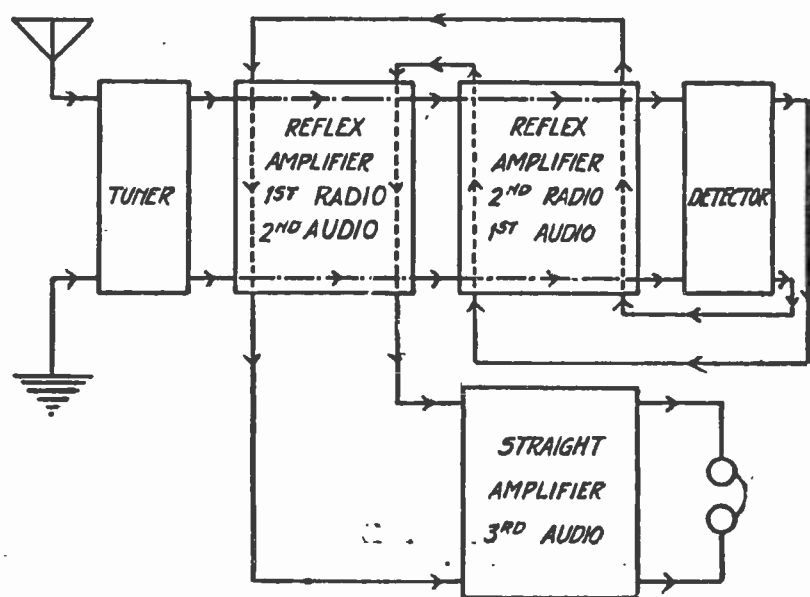

FIG. 6

The inverse reflex system usually known by the trade name as the "inverse duplex"

an unqualified success with the circuit. The other fellow has done the experimenting on it, it is now on a *pro bono publico* basis.

There are several inherent disadvantages in the reflex scheme. In the first place there are currents of widely different frequencies in the amplifier tubes. It is not the fact that these frequencies are far apart that matters, for therein lies its success, but the fact that the tubes are doing double duty. Their plate circuits are traversed by two currents, either of which may be enough to overload the tube.

Receiving from a local station may cause the entire straight portion of the tube "characteristic" to be used. Addition of more voltage from any source may cause the curved portion of the characteristic to be used—and this means modulation or distortion.

Overloading is particularly liable to take place if high ratio transformers are used. This effect was described in the article on audio-frequency amplifiers in RADIO BROADCAST for November, 1924. The remedy, of course, is the proper C battery and a lower turn ratio. As far as the writer knows there is no very high ratio transformer on the market to-day with a proper characteristic, so that one is safe only by avoiding the "10 to 1" coils.

Another defect is the introduction of high

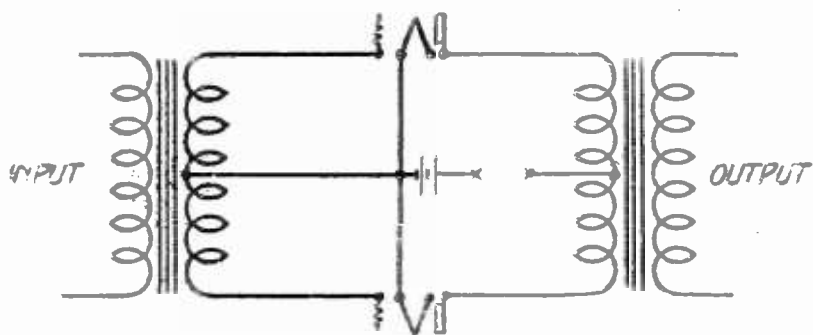

FIG. 7

The usual push-pull audio-frequency amplifier circuit. A special case of the push-pull circuit is discussed in the accompanying article

resistance into the various circuits, either through the transformer winding or by the crystal detector. This makes tuning broad, and in the crystal case it makes the tendency toward oscillation somewhat greater. For this reason, potentiometers are used to make the amplifier grids positive—a bad practice at best. Every adjustment of the crystal changes the resistance in the circuit, and necessitates readjustment of other parts of the set. Under certain conditions better signals may be obtained by removing the crystal contact, a sure sign that something is wrong. Often a point may be found that gives loud signals which if used in an ordinary crystal circuit would not be sensitive at all. This is due to the semi-regeneration which occurs in the circuit and is caused by the crystal resistance.

THE PROPER TRANSFORMERS

PROVIDED the ratio is not too high and the resistance not too great, any good audio transformer may be used in reflex circuits. Here as in any other audio amplifier circuit, only the best transformers should be used—if one is interested in quality as well as quantity. Much depends upon the proper value of by-pass condensers, and the poor quality emanating from some reflexes may be traced to these small components.

For example, a small condenser placed across the secondary winding of an amplifying transformer has the same effect as a large condenser shunted across the primary. The result is that high frequencies find a ready path through this effective primary capacity, and they naturally refuse to bother going through the transformer. The average transformer is a poor device anyway beyond 3000 cycles and when shunted by a condenser of too large a capacity it misses most of the high notes.

The coming year promises much in the way of good transformers. The writer has seen one new coil that will probably be on the market by the time this is being read and doubtless

others are being perfected. The overall amplification of this transformer and a UV-201-A tube is far beyond that attained at the present time in the point of equality of amplification over the audio band. The future of radio seems to point toward better and better reproduction, a future that will be present as soon as more nearly perfect transformers are for sale.

PUSH-PULL REFLEX HOKUM

DURING the past year, the writer has seen several articles on how to reflex a push-pull amplifier. Enormous amplification is claimed, as one might suppose from getting two tubes to act as four. Who couldn't get signals loud enough to stop the clock with a four stage amplifier, one of which is push-pull?

What is wrong with this scheme?

Fig. 7 is the conventional push-pull amplifier. Between the B batteries and the output winding are two "X's" which should normally be connected together. Now the great advantage of the push-pull amplifier connected as shown, lies in the fact that all of the distortion due to overloading is balanced out, appearing only at X and not in the output. If one placed his receivers at X he would get all of the distorting harmonics and none of the fundamentals.

Fig. 8 is one of the reflex schemes. The normal output is fed back into the input as

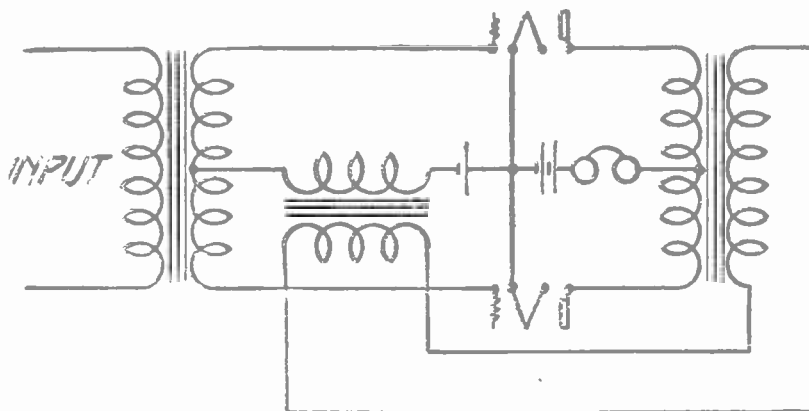
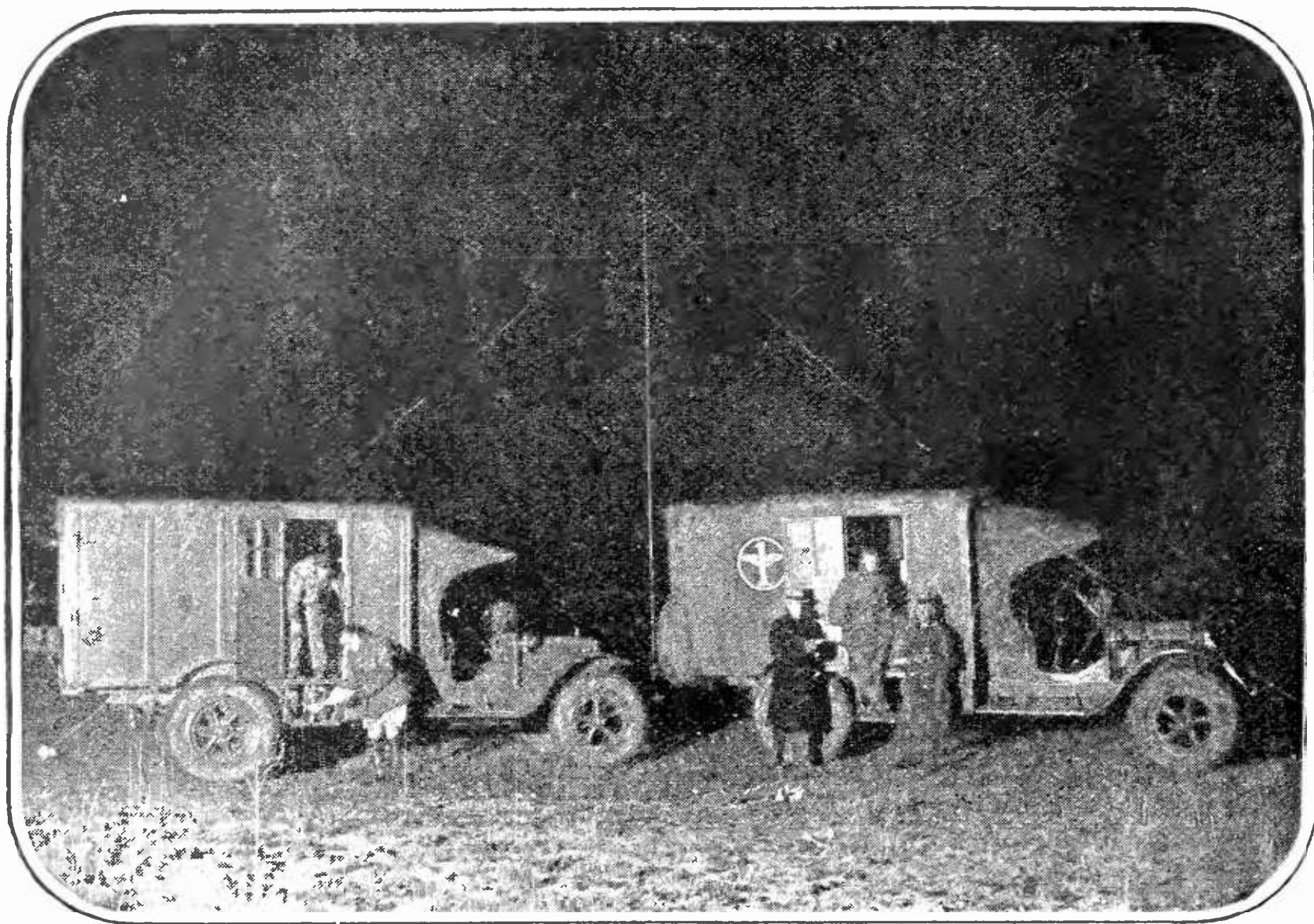

FIG. 8

A reflex scheme which has been exploited to some extent which contains a serious technical flaw explained in the article

shown and the receivers are placed where the distortion is greatest. Another scheme is to interchange the output coil and the receivers, thereby sending the distortion around again. In either case the amplifier will probably howl, and should if it does not, for here is a straight case of feeding the output back into the input without the usual ceremony of changing frequencies! Other ideas, fully as unnecessary, have appeared for reflexing the push-pull transformer arrangement as if it were not valuable enough by itself.



JUST BEFORE ELEVEN O'CLOCK

On the first night of the International Radio Broadcast Test at Mitchel Field, Long Island Under command of Capt. H. M. McClellan, men of the 5th Observation Squadron, U. S. Air Service, set up special radio receiving and transmitting trucks shown in the photograph. Communication was maintained with the laboratory of the magazine by short wave radio telephone and code. Various stations in England, France and Radio Iberica, Madrid, were heard here

The International Radio Broadcast Test of 1924

A Review of the Second Annual Test Between Europe and America—What They Proved Socially and Technically—Sidelights on the Event Which Interested Nations

BY ARTHUR H. LYNCH AND WILLIS K. WING

THE thousands of letters, telegrams, telephone calls, and personal messages which we received during and after the International Radio Broadcast Tests, concluded a short time ago, proved conclusively that the signals from foreign broadcasting stations were heard in every nook and cranny of the United States. Reports came with surprising accuracy and regularity from California and Oregon as well as New York State and Maine.

The average moderate-sized house has, perhaps, twenty-five forty-watt electric lamps to light it, which consume about one kilowatt of energy. Consider, then, that these avid and enthusiastic radio listeners who strained at their receiving sets each night of the tests were trying to pick up signals from transmitting stations using a power equivalent to that consumed by about fifteen forty-watt lamps, and then marvel, as we all do, that the foreign broadcasts were so generally and so well heard.

Marconi, when he hoisted his kite aerial near St. Johns, Nova Scotia, on December 6, 1901, used twenty-five kilowatts of power in trying to push the historic letter S across the stormy reaches of the Atlantic. The English and Continental broadcast pioneers, A. D. 1924, were using five hundred watts, less than one fiftieth of that power! It took Marconi weeks of effort to record the signal S, with no other obstacles but natural ones and the crude receiving apparatus at his command. North American listeners were trying to hear foreign programs with receiving sets of advanced design, it is true, but against great odds. Your listener, in 1924 not only had the difficulty of unusually unfavorable natural conditions, but he had to cope with man-made interference which is well-nigh impossible to overcome, in the form of squeals and howls from improperly designed and operated receivers, which were so pernicious in almost every locality you could name, that receiving with any great degree of success was nearly impossible.

It is safe to say that every one of the broadcasting stations in Europe and England was heard at one time or another during the tests while but few of the American stations were heard abroad. Those that were heard were

using power considerably above the average. Inasmuch as the average European transmitter is not capable of any greater range than the transmitters used here, it seems reasonable to assume that our receivers are more sensitive than those used by the average listener in foreign countries. It will be remembered that but few of the European stations were heard in this country last year, which would seem to indicate that we have improved our receivers very materially during the past twelve months. Within the next year one can assume that additional improvements will be made in receiver design. It is also probable that high-power broadcasting stations, now being seriously considered, will result in much better reception of our programs by foreign listeners.

When a receiver is made more sensitive, it is more susceptible to interference as well as more responsive to the signal desired. It may, therefore, be desirable to use greater power for broadcasting of this nature. Then, too, there is the possibility of broadcasting on short waves for the purpose or rebroadcasting in a distant locality or foreign country. A very excellent indication of the progress being made in this direction may be seen from the success with which the programs from KDKA, the

Pittsburgh station of the Westinghouse Electric and Manufacturing Company were re-broadcast by the British Broadcasting Company during the tests.

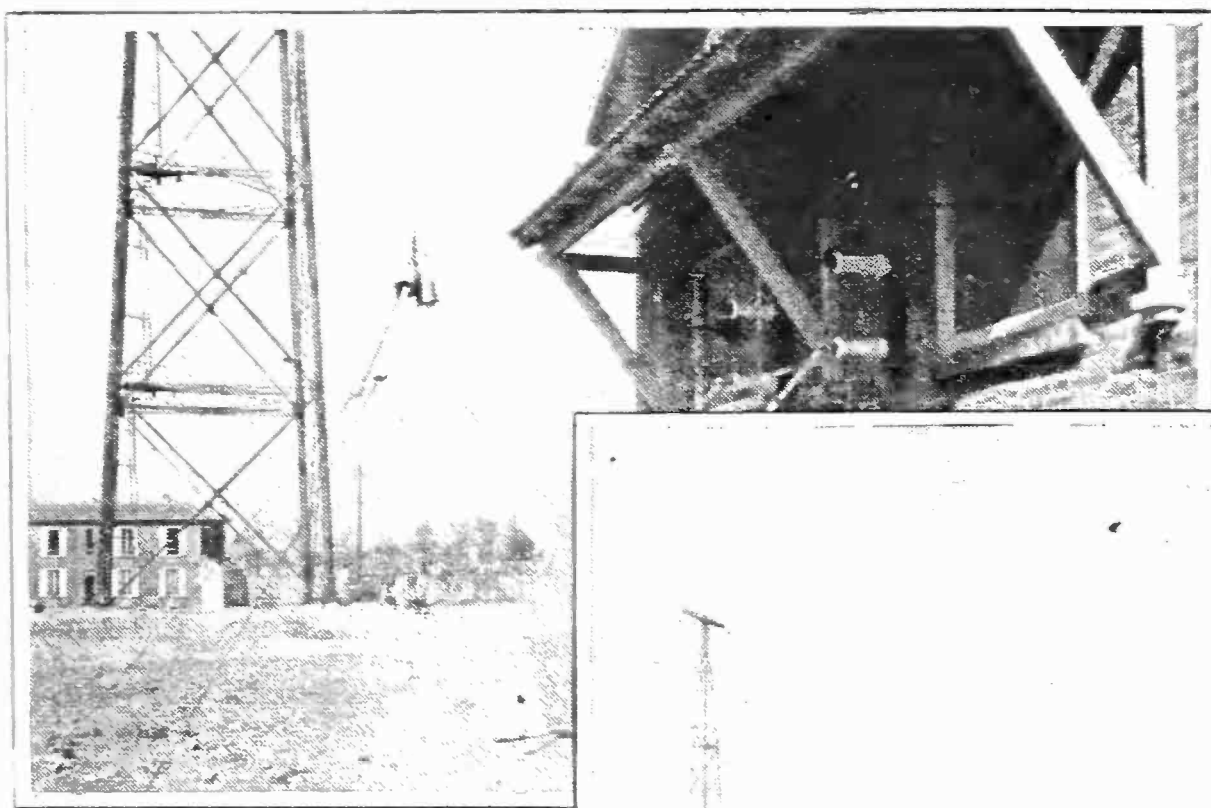

THE "RADIO PARIS"
STATION AT PARIS

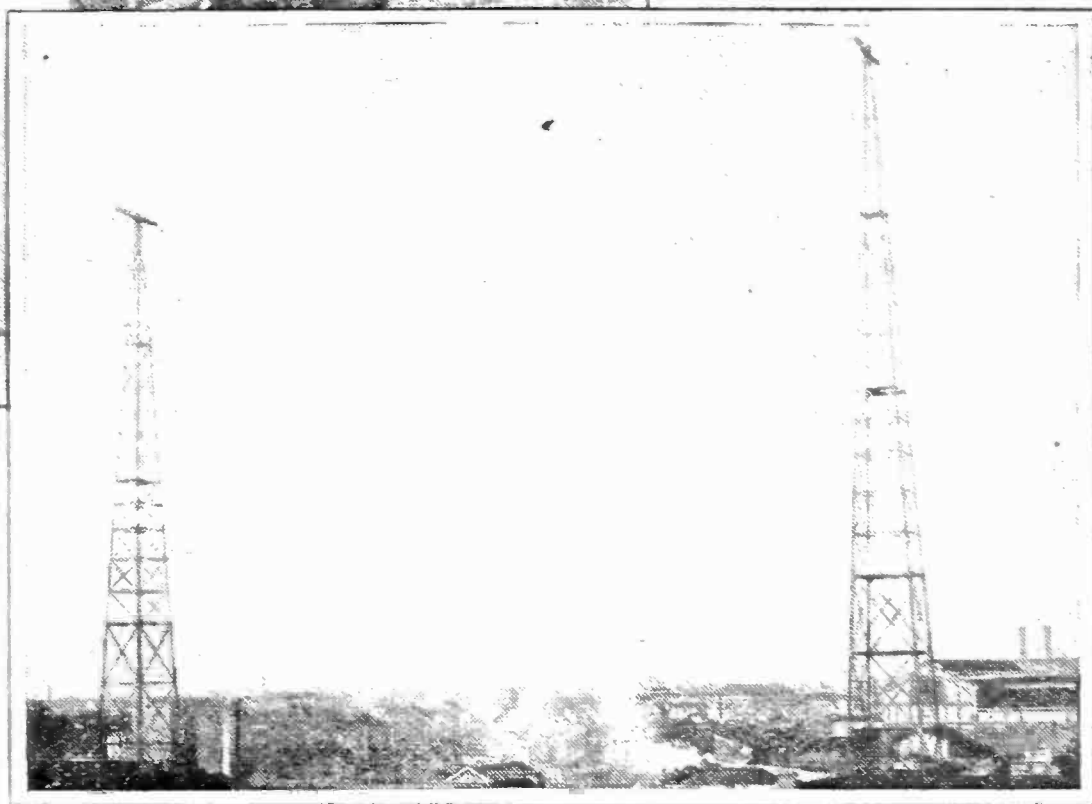

With the logical assumption that more powerful American signals will be available in our tests next year, it is probable that American programs will be more generally heard abroad than they were in 1924. And when we assume that perhaps more power will be available from broadcasting stations abroad and that our receivers will be improved in design and operation alike, completely satisfactory international broadcasting will without question move another step nearer.

RECEPTION IN THE UNITED STATES IN
1923 AND IN 1924

WE HAVE been asked how reception in North America during the tests this year compared with that of last year. In 1923, the English stations were reported in every section of the United States and in many parts of Canada by relatively few listeners. This year, the English and Continental stations were reported by literally thousands and thousands of listeners in every part of the nation. Many more cities and towns were represented. The difference may be laid, first to the hearty coöperation of American, Canadian, Mexican, Porto Rican, and Cuban

broadcasters in keeping off the air during the foreign transmission times. Secondly, receiver design has improved, and thirdly, the owners of those receivers have grown more expert in their operation.

As a striking example of what can be done in the future, the reception of Mr. F. R. Hoyt, of Stamford, Connecticut, is of considerable importance. Each evening of the test he brought in the foreign programs with such volume that he was able to make phonograph records of them.

A listener on a small island off Beverly, Massachusetts, where there were no radiating receivers about, carried foreign programs almost without interruption until the distant announcer stepped away from his microphone and closed the program.

Several listeners of Maumee, Ohio, a suburb of Toledo, on several occasions received the foreign stations with clarity that they were able to put the loud speaker near the telephone which was connected by long-distance lines to our office in Garden City, nearly seven hundred miles distant. We heard a part of the program picked up from Madrid and Paris.

One of our readers who used a Knockout

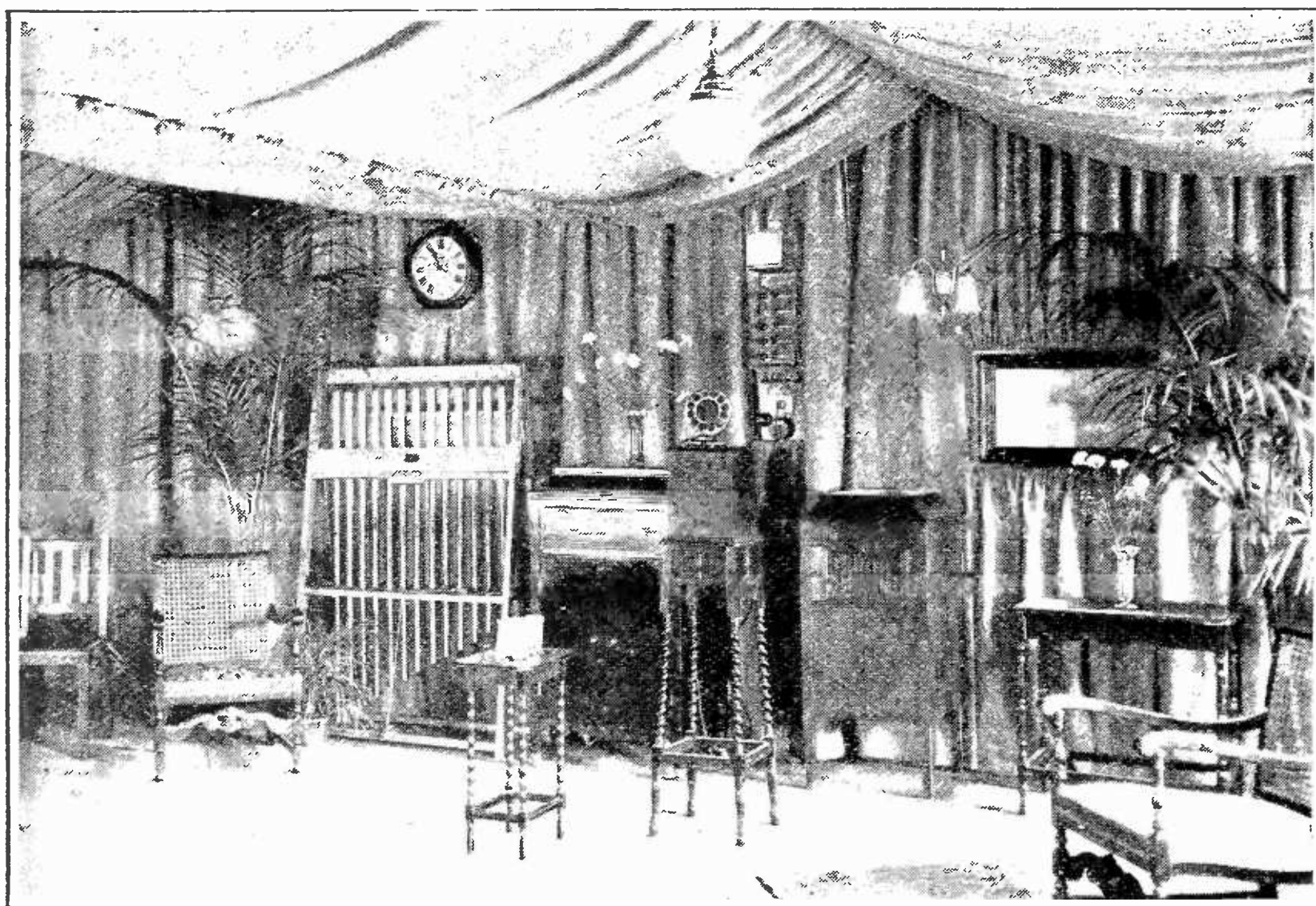

THE STUDIO AT BOURNEMOUTH, STATION 6 BM

The signals from this station, operating on a wavelength of 385 meters were generally heard all over this country. The installation here looks more like that of the average American studio because the apparatus is that of the Western Electric Company

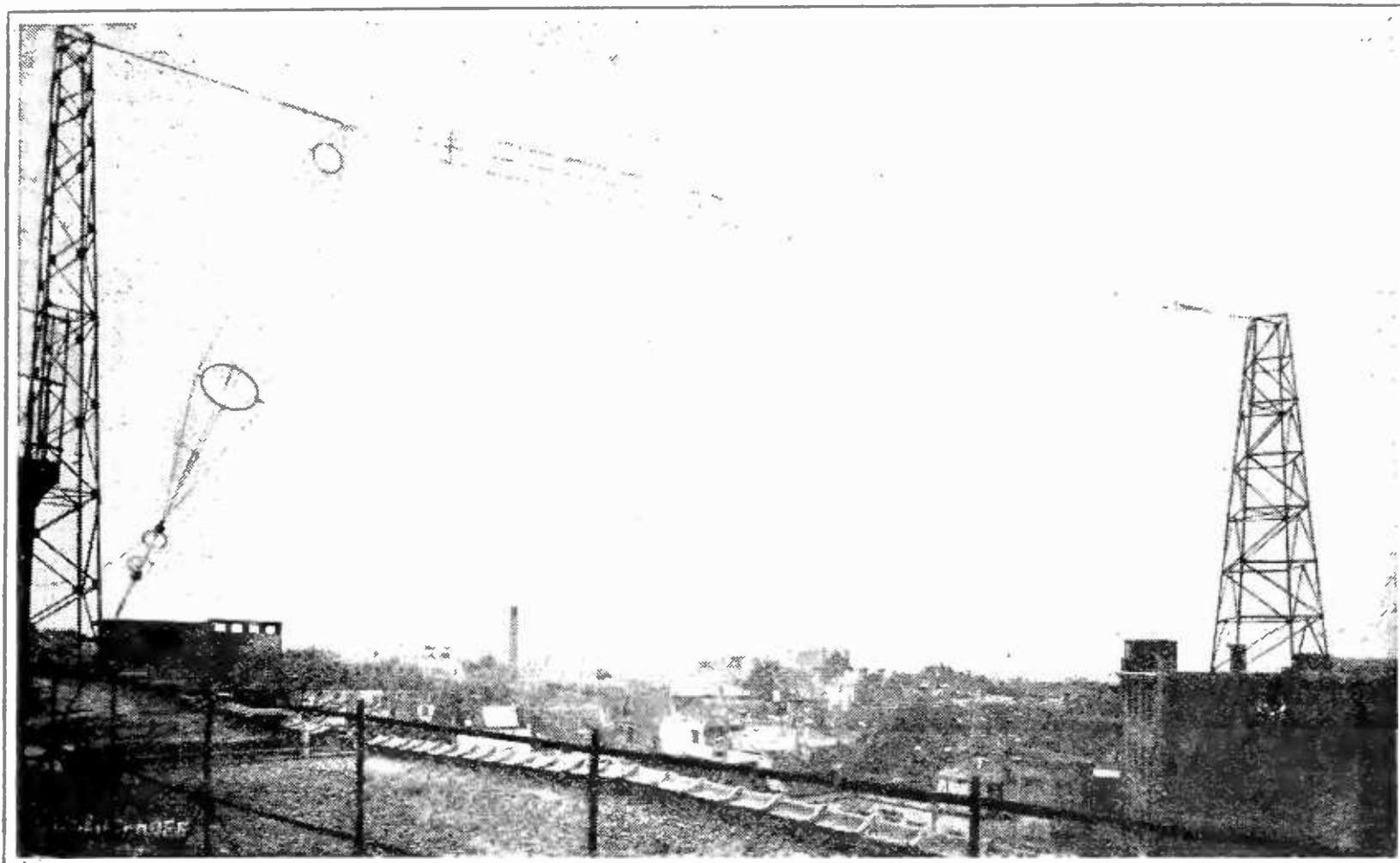

STATION SBR BRUSSELS

Signals from this station, on 265 meters were reported as far west as Denver, Colorado

four-tube receiver at his home on Long Island received Madrid every night they broadcast with intensity enough to permit a group of his friends plainly to hear their programs through the loud speaker.

Verified similar instances of just this sort occurred times without number all over the country as any reader may discover by inquiry in almost any radio group.

THE COMMUNICATIONS AT HEADQUARTERS

HAD the announcements from foreign stations been more frequent, the total number of verified North American listeners to those stations would without question be enormously increased. Many heard fragments of programs and even one or two complete musical numbers but the station faded out before the announcement was made. This made the work of verification at our office much more difficult, because the foreign stations were transmitting between four and five o'clock in the morning their time, and it was obviously very difficult to get many artists at their studios at that time. Their programs depended much on the ingenuity of the studio manager. Most of the selections broadcast from the English stations were phonograph records of well-known operas, although organ music was sent from several of the English stations during the early nights of the tests.

Very general good sportsmanship was shown by listeners on this side who heard programs on wavelengths on which no American stations were sending. These listeners wrote us, wired, and telephoned about the signals they had heard, but made no effort to claim reception when they had not intercepted a definite announcement.

But there were other sides to the communications. "Last night, at 11:20, I heard a woman singing a soprano solo. What foreign station did I hear?" was a question asked more than once, probably in all seriousness. A radio enthusiast in Costa Rica wrote in that he had heard nothing about the tests until on the second night, he heard announcements from several American stations. Accordingly, he tuned-in on the foreign wavelengths and heard the test programs in succession from both continents. Another listener in Denver, Colorado, wrote in to ask what American amateur station was using the call letters 5 NO, saying that he heard a radiotelephone program whose operator used that call. It should be remembered that American amateurs use call letters beginning with numerals.

THE ARRANGEMENTS IN ENGLAND

THE burden of making the extensive and difficult arrangements for the tests on the Continent and in England fell on the capable shoulders of Hugh S. Pocock, editor of the

Wireless World and Radio Review. Mr. Pocock, working with the British Broadcasting Company in the tests of 1923 made the complete arrangements then, and coöperated with them in verifying reports and in answering correspondence with the great number of interested British listeners. This year, his problem was a vastly more difficult one. Arrangements with scattered broadcasting stations on the Continent had to be made. Programs were finally arranged with stations in Spain, France, Belgium, Italy, Denmark, and Germany, and difficult problems were excellently solved. Working in close coöperation with him was Captain A. G. D. West, assistant chief engineer of the British Broadcasting Company, and when Captain P. P. Eckersley, chief engineer of that company, returned from his trip to this country to attend the Hoover Radio Conference in Washington, he, too, lent his valuable aid.

North American listeners owe a great debt to the broadcasters abroad who sacrificed their rest for seven nights and sent programs from four to five A. M. It was no small task to maintain their regular schedules and to make the necessary arrangements for the special late test programs as well.

The operators at the high-powered transatlantic stations of the Radio Corporation of America at Carnarvon, Wales, and at Christiania, Norway, listened for American broadcasting, and were successful in hearing many complete programs.

ARRANGEMENTS IN THE UNITED STATES

THE first task on this side was to secure the coöperation of the five hundred and fifty American broadcasters. This meant the sacrifice of probably their most valued program hour to allow listeners here a clear ether for the foreign signals. Without notable

exception they agreed to make every necessary arrangement. In Canada, Mr. Jacques Cartier, director of station CKAC, *La Presse*, at Montreal undertook to make arrangements with the fifty-odd stations north of the border. Coöperating with him were the independent stations and the large chain operated by the Canadian National Railways. In addition, the Cuban Telephone Company aided, with their station PWX, as did other Cuban broadcasters. Station WKAQ, at Porto Rico, also joined in the arrangements. The stations of *El Excelsior* and *El Universal* in Mexico City helped as well.

Among the organizations who lent their best efforts toward the success on this side were the United States Army Air Service, who extended their facilities at Mitchel Field, Long Island, the General Electric Company, who gave complete information about the tests through their various stations.

In transmitting periods from this side station WGY made all their announcements in five languages

to make identification of their signals easy for foreign listeners. The Radio Corporation of America had the operators of their high-power stations listen for foreign broadcasting, and the staff at their Chatham station turned in several complete logs of reception. The broadcasting stations of the Corporation took a very active part in the tests as well. In addition, the Westinghouse Electric and Manufacturing Company gave the full support of their stations and on at least one night, programs from KDKA were re-broadcast in England for listeners there. The Radio Trade Association, the American Radio Association, the National Association of Broadcasters, the Esperanto Association, and the Ilo Association were most effective in their respective fields.

Newspapers throughout the country were most active in covering the tests as a piece



CAPTAIN H. M. MCCLELLAN

—United States Army Air Service, at a special super-heterodyne loaned him by RADIO BROADCAST. This is the same "super" which was successful in reaching out to London and other English stations in the transatlantic tests of last year. This receiver brought in Madrid, Bournemouth, Newcastle, Cardiff and Paris this year

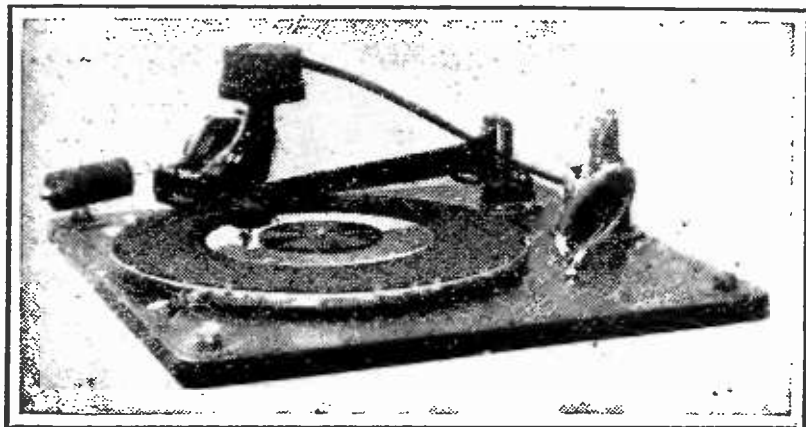

THIS DEVICE RECORDED FOREIGN BROADCASTING ON A DISC RECORD .

A series of thirty records was made by Mr. F. R. Hoyt, of Stamford, Connecticut, using this method of recording the signals. These discs show very plainly how considerable was the interference effected by the users of oscillating receivers. Some of the foreign signals recorded came through with great volume

of important international news. Practically every paper listed local test listeners who heard the foreign stations. Radio editors of many of the dailies were in touch with our offices by telegraph and telephone exchanging information. Some very complete and careful logs and reports came to us from a number of radio editors who took great personal interest in the tests.

Almost a thousand manufacturers of radio receivers were assigned official numbers and acted as official receiving stations and were most helpful in submitting reports of their reception. And other manufacturers sent receiving equipment and in some instances sent engineers to install and operate it, at our headquarters, at Garden City. These receivers were successful in many instances in picking up the foreign stations and, by means of liaison maintained between them by special buzzer circuits put up for the purpose, it was possible for several receivers here to keep an accurate log of several foreign stations at the same time. These logs were very valuable in checking the reports from listeners throughout the country, which began coming in by telephone before the hour for receiving was completed.

AT GARDEN CITY

THEN, too, it was possible for us to keep in touch with the three receiving sets operated at Mitchel Field by means of the short wave transmitter, which was loaned us by the Radio Corporation of America for that purpose.

Many of the manufacturers, who had accepted assignments to act as official listeners,

went to no end of trouble to see that their work was effective. In several instances they had receivers installed in four or five different locations and arranged for telephone communication between them, in order that each would have a check on the others and so that the reports of reception could be wired to Garden City as soon as practicable.

The Western Union Telegraph Company and the Postal Telegraph Company made great effort to see that listeners knew where to wire their requests for verification of foreign broadcasts before the tests actually took place. The former organization went to the trouble of distributing more than two million circulars, telling people how to route their telegrams to us, in order to expedite their delivery.

Several manufacturers offered prizes for the best reports of reception of the European stations with receivers of their manufacture and in one instance they called upon us to pick the winner.

Many of those who took part in the tests last year will remember that the listening periods were only half an hour in duration, while this year the much more satisfactory period of one hour was put into effect. Next year we hope to have the test so well organized that no hitch whatever will arise and it is probable that a representative of RADIO BROADCAST will visit Europe in order to arrange the programs, so that a check of the broadcasting carried on during any test period will be found in the papers throughout this country and Canada the next morning. We



©Underwood & Underwood
A SILVER CUP

Was presented by J. D. R. Freed, president of the Freed-Eisemann Company to Mrs. Edna M. Smith of Springfield Gardens, Long Island, the first listener using one of the receivers manufactured by that company who heard verified foreign signals

hope to arrange a program which will be adhered to very closely, on which there will be a very close time check and it is very likely that the European broadcasters will make much more frequent announcement of their call letters and location, since the shortcomings of this year's effort have been brought to their attention.

It is very likely that with a year in which to make our preparations and inspired by the great success we have had this year, it will be much simpler for us to enlist the aid of those who have, up to now, been somewhat lukewarm concerning the interest they believed listeners would take in tests of this nature. What more conclusive proof could there be of this interest than the fact that hundreds of thousands of us, everywhere in the North American Continent, Europe, and Australia, spent approximately two hours each night for a solid week listening to (or in some cases just listening for) stations in other lands?

THE RESULTS

THE International Radio Broadcast Tests interested great numbers of people who had yet to be convinced of the possibilities and benefits of radio. They showed to practically every listener that the menace of the radiating

receiver is so serious that some definite, militant, and constructive measures have got to be taken in the very near future to protect radio receivers and to give listeners an air clear from artificial, unnecessary, and absurd man-made interference. And, too, they brought listeners on this continent a little closer to their brothers across the sea.

We have long talked in beautifully figurative language about "hands across the sea," but now in a very real sense we have voices across the sea. No matter now if the voices could not deliver any very complete message. It is enough that one entire continent was listening for another, that radio folk grew to think even for a short time of those on the other side. The start has been made, and in the years of progressive technical experiment, trial and error to follow, we shall get nearer and nearer to nations which before had been but names on a complicated map, or dull words in a newspaper story.

The important thing is that the effort has been made, that the electrical ice has been broken. The task is the engineer's now, and in his capable hands we can well leave it. It requires no glib gift of prophecy to think of close radio unity in future years with every nation of the globe.

Hon. Alejandro Berea, the Consul General for Spain at New York, in an address recently made at a luncheon attended by a number who participated actively in the direction of the International Tests phrased very well his conclusions about the tests:

I most heartily congratulate the organizers of this communication across the Atlantic, and I am sure that the spiritual compenetration between Europe and America will be thoroughly perfected within a short time by the use of scientific transmitters and receivers; and Spain, on account of its geographical position and because it is one of the nations of continental Europe nearer to this country, will be one of the first to avail itself of the benefits of broadcasting and be in contact with America, which is bound to it by the ties of ethnography and history.



A CLOSE-UP OF ONE OF THE ARMY RECEIVING TRUCKS At Mitchel Field, showing the receiver and transmitter installed and a group of officers and men. Capt. McClellan is holding to the iron strap on the truck. The night this photograph was taken it was extremely cold, and there was no illumination except that furnished by lanterns and flashlights. The officers took the radio truck out to the center of the landing field, away from all obstructions and listened for the foreign broadcasts, which they heard, at times badly interrupted by blooming receivers

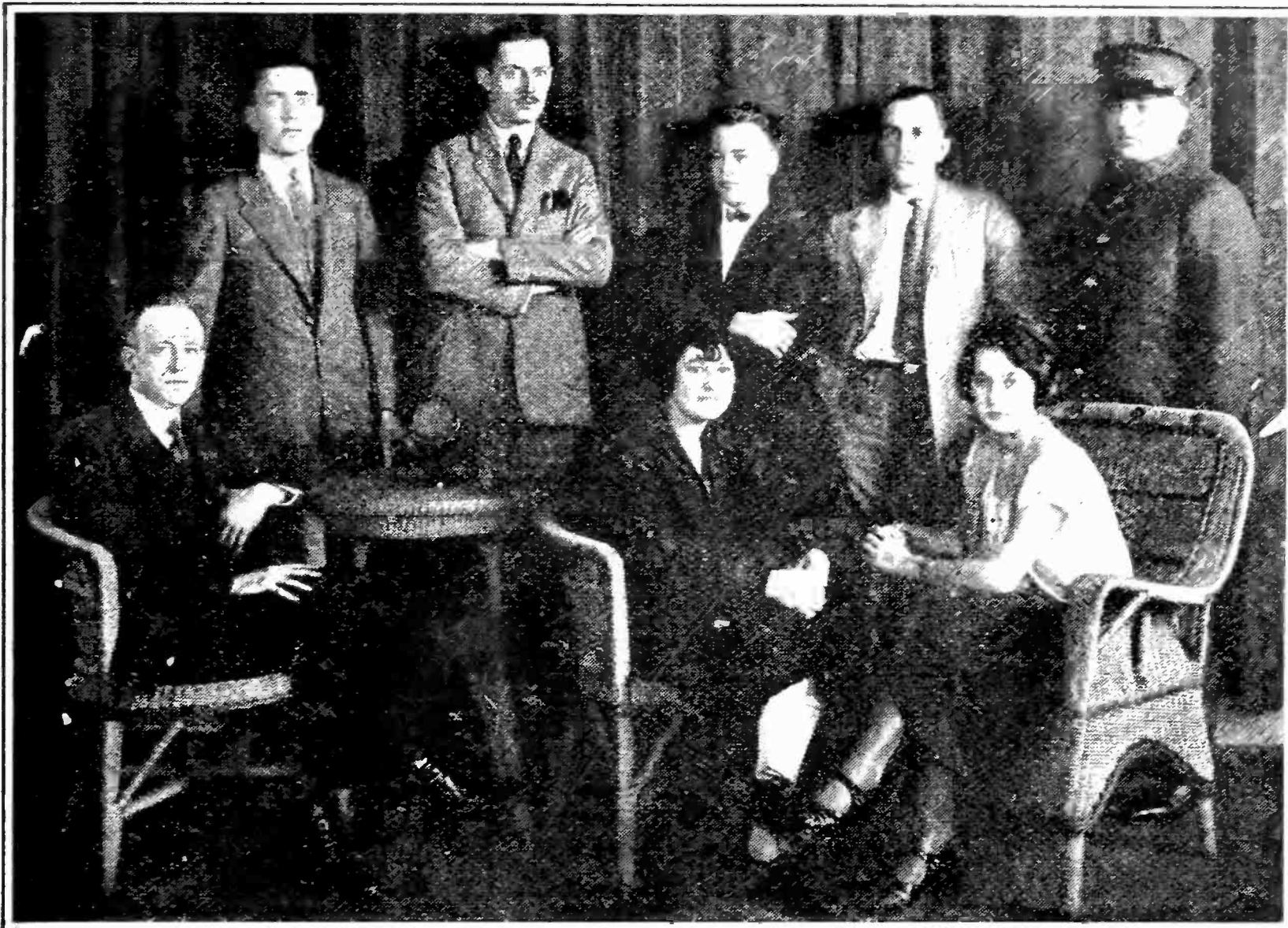

IN CHARGE OF CANADIAN COÖPERATION

For the International Radio Broadcast Tests was the staff of station CKAC, *La Presse* Montreal. J. N. Cartier, the fourth from the left in the last row, director of the station, completed his arrangements with brother Canadian broadcasters for participation in the International Tests. In the back row from left to right are Arthur Dupont, assistant announcer; Adrien Arcand, radio editor of the paper; Leonard Spencer, technician. J. N. Cartier; A. Lebeau, master of ceremonies; Front Row, J. P. Calligan, "Father Radio"; Mary Brotman and Nora O'Donnel, stenographers

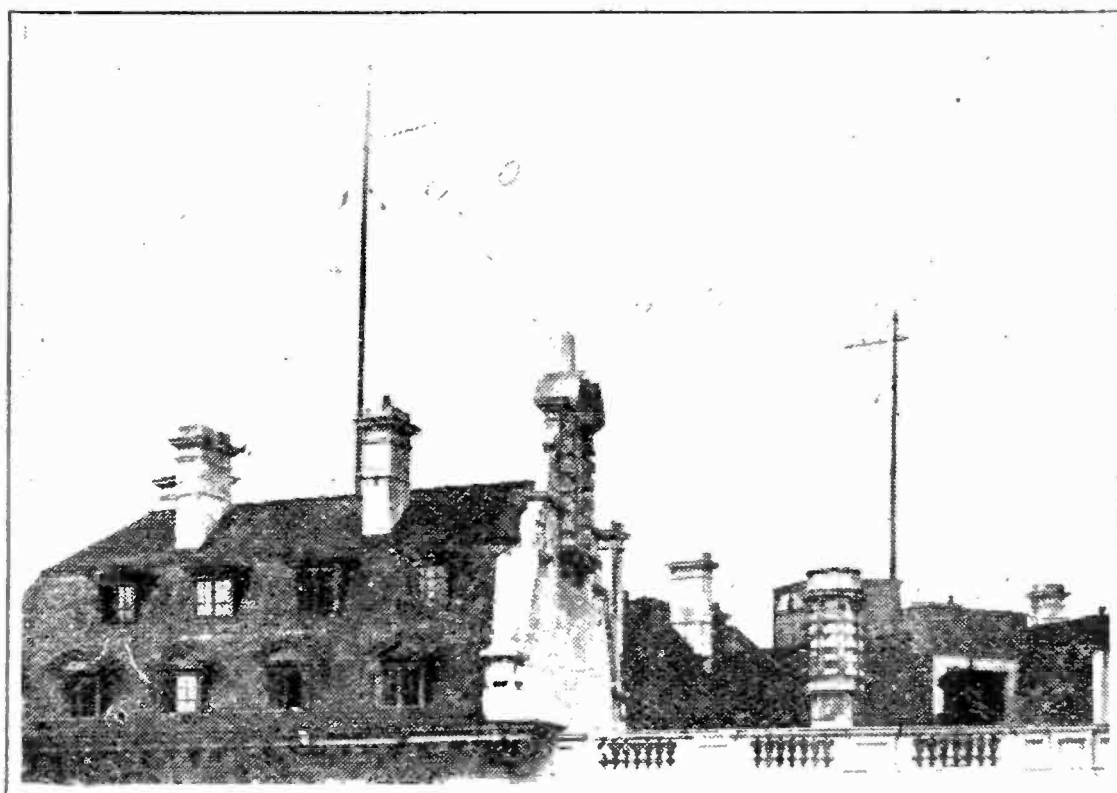

THE NEW ANTENNA AT 2LO

The London station of the British Broadcasting Company. A good part of the English programs during the tests were simultaneously broadcast from this studio through the various other Island stations, linked to London by wire

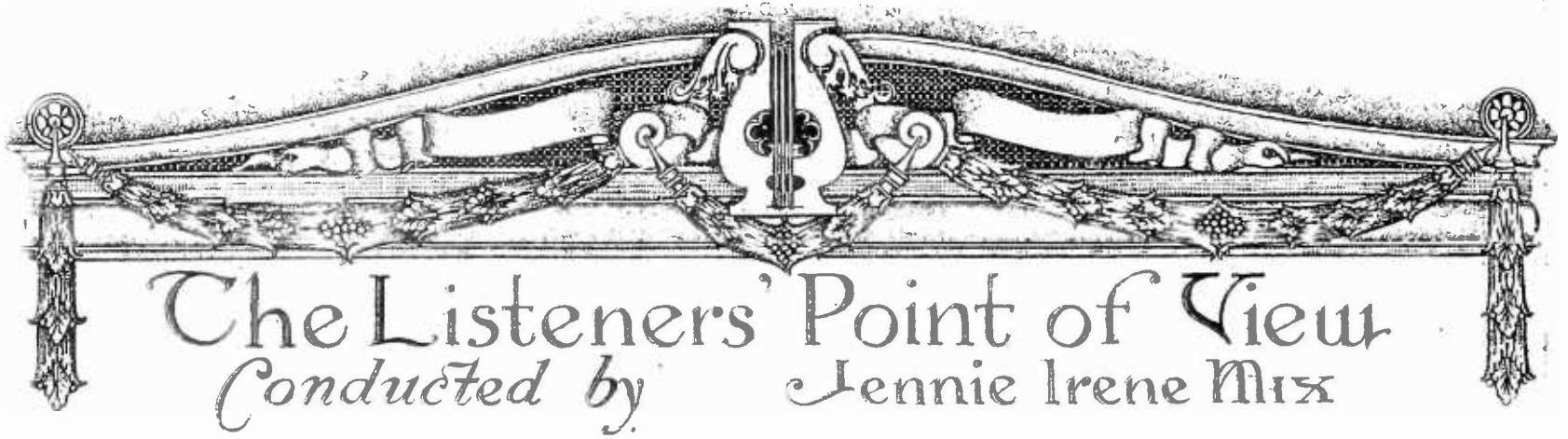

What is Going to Happen to Radio Advertising

PERHAPS this much discussed question of advertising by radio will ultimately be settled by the advertisers themselves. They may find that the returns in sales in no way measure up to the amount expended in getting the name, and in some instances a description of their product, to the radio public. And, again, even under these circumstances, they may keep right on engaging broadcasting privileges at so many dollars per minute, just as they keep on sending out sales letters although not more than a half dozen out of a hundred letters usually bring returns.

One feature of this question, however, seems bound to be settled but one way. This is, giving the listener-in the privilege of knowing that advertising is about to be broadcast. Of course, when a musical organization or a monologist bearing the name of a well-known commercial product is announced, that is easy. Twist the dial if you do not want to listen. But when a man is announced as a speaker on "The products of the Province of Paragon in Paradisio," with but a murmured postscript, "Mr. Blank is pleased to take advantage of the facilities of this station to talk to you," then, beware! You may listen quite a time before you catch on to the fact that Mr. Blank is telling you about these products because he wants you to buy them.

The radio audience will eventually take care of this unjust manner of radio advertising. They will tune Mr. Blank out, and they will do this to such an extent that even the low average of returns from sales letters will seem to him, in comparison, an almost alluring margin of profit.

It is these veiled advertising talks, and not the performances of orchestras, singers, and monologists, that arouse the ire of the listener. When "The Gold Dust Twins" are announced, or "The Eveready Quartet," and other organizations or individuals broadcasting wholly for advertising purposes, that is a straight-from-the-shoulder game. It is offered you with no subterfuge back of its promotion. You may take it or leave it, as you please. And, in all fairness, it must be acknowledged that very often these performances put on by commercial houses to advertise their goods are superior in quality to similar attractions not paid for by advertisers but put on the broadcast program by the director who must choose his talent from the hodgepodge group of people he may be able to persuade to work for him for nothing.

The plea of the broadcasters that they cannot afford to entertain the public for nothing, and therefore they must accept advertising numbers for which they are paid, does not make any impression on the intelligent portion of the radio public. No one asked these broadcasters to erect and operate their station. A goodly number of them could go out of existence overnight and no one would complain. Many, indeed, would rejoice! This because, with some few and notable exceptions, all the stations put on the same character of programs, cheap enough, at best, and ones that are given with the same uniform mediocrity of performance. These broadcasting stations are maintained for the purpose of reaching the largest number of people possible, rather than with the desire ever to make an appeal to a discriminating public.



CARYL MARSHALL, SOPRANO

Who recently was heard through station wcy. Miss Marshall was one of the winners in the Juilliard Scholarship test held in New York not long ago, and in which were entered competitors from all over the country

The attitude of the directors of such stations is, to a degree, similar to that of the merchant who sells to all classes of people because this is the sensible way in which to conduct business. But the wise merchant keeps a quality of goods that will appeal to customers of refined taste, the while he also has a "bargain basement." Yet the same merchant will go to the enormous expense of installing and maintaining a broadcasting station to advertise his store, and then permit the director of that station to put on programs that appeal only to "bargain basement" customers. Poor advertising, this!

The owner of a broadcasting station that permits paid advertising has a strong argument in his favor when he wishes to defend himself. He can justly say that, only as long as no one is paid for broadcasting, every number on every program is in the nature of advertising. He will tell you that the persuasion brought to bear in order to get contributors to programs is that their names going out over the air to countless listeners is a rich source of advertising. And so it is, provided they prove worth the hearing.

During the last two months an increase has

been noticed in the number of good musicians of fairly wide reputation who have broadcast. To be sure, their number is so small compared with the mediocre talent presented that they are all but lost in the mass. But they have been heard and greatly enjoyed. Perhaps some, or all, of them are paid. We have a very strong suspicion, pretty well justified in one or two cases, that certain stations are growing tired of giving programs by "microphone pluggers," as they are designated in the studios, and are engaging the best talent available in their vicinity and paying for it.

To a director who desires to put on fine programs and cannot do so because the company for which he works will not give him any money for this purpose, it must be a godsend to find promoters of public concerts who are willing to have their attractions broadcast. The best stations, so far as the present writer's knowledge goes, never miss such a chance. This shows what sort of music they would give the public if they had money to engage good artists.

Among the features of this character that have recently lifted radio music above its accustomed dullness, are the concerts of the

St. Louis Symphony Orchestra broadcast by station KSD, and commented on in this department last month. Others of notable quality are the Wednesday night programs of the New York Philharmonic Orchestra, broadcast through WPAF. Also, through WPAF, the series of New York programs being given by George Barrère and his Little Symphony Orchestra. Mr. Barrère, it is scarcely necessary to explain, has been for more than twenty years first flutist in the New York Symphony Orchestra, coming to this country from Europe to join that organization. He is not only the most famous flutist in America but also has no superior in Europe. For some years he has been at the head of the Little Symphony, which he organized and which confines itself mainly to playing works not suitable for a large orchestra. The broadcasting of his series of New York concerts this season is doing much to lift radio music from its deadly monotony.

Then there are the programs of the American Orchestral Society heard through WJZ and WJY. This

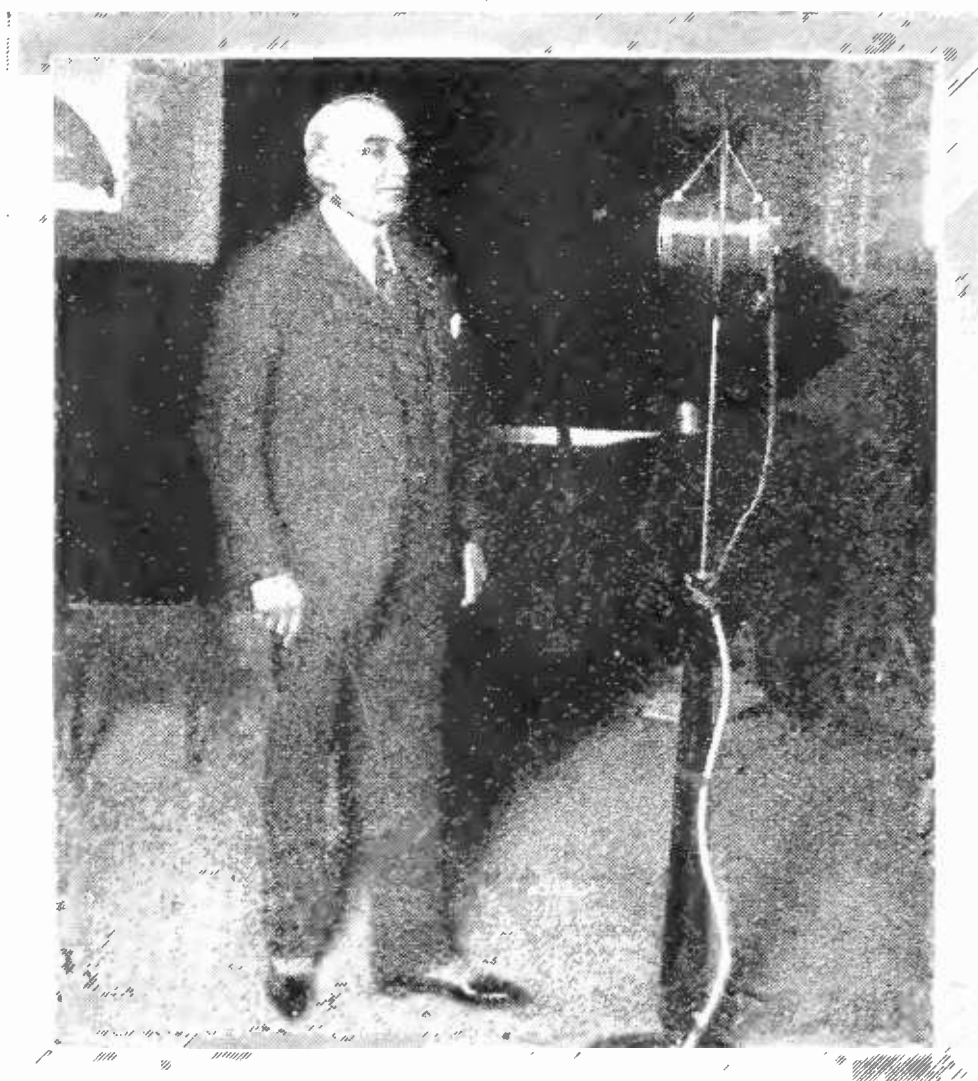

LEON ROTHIER

One of the greatest operatic passos ever heard in this country, and who has for many years been with the New York Metropolitan Opera Company. He is here seen broadcasting from station CKAC, Montreal, prior to a concert given in that city.

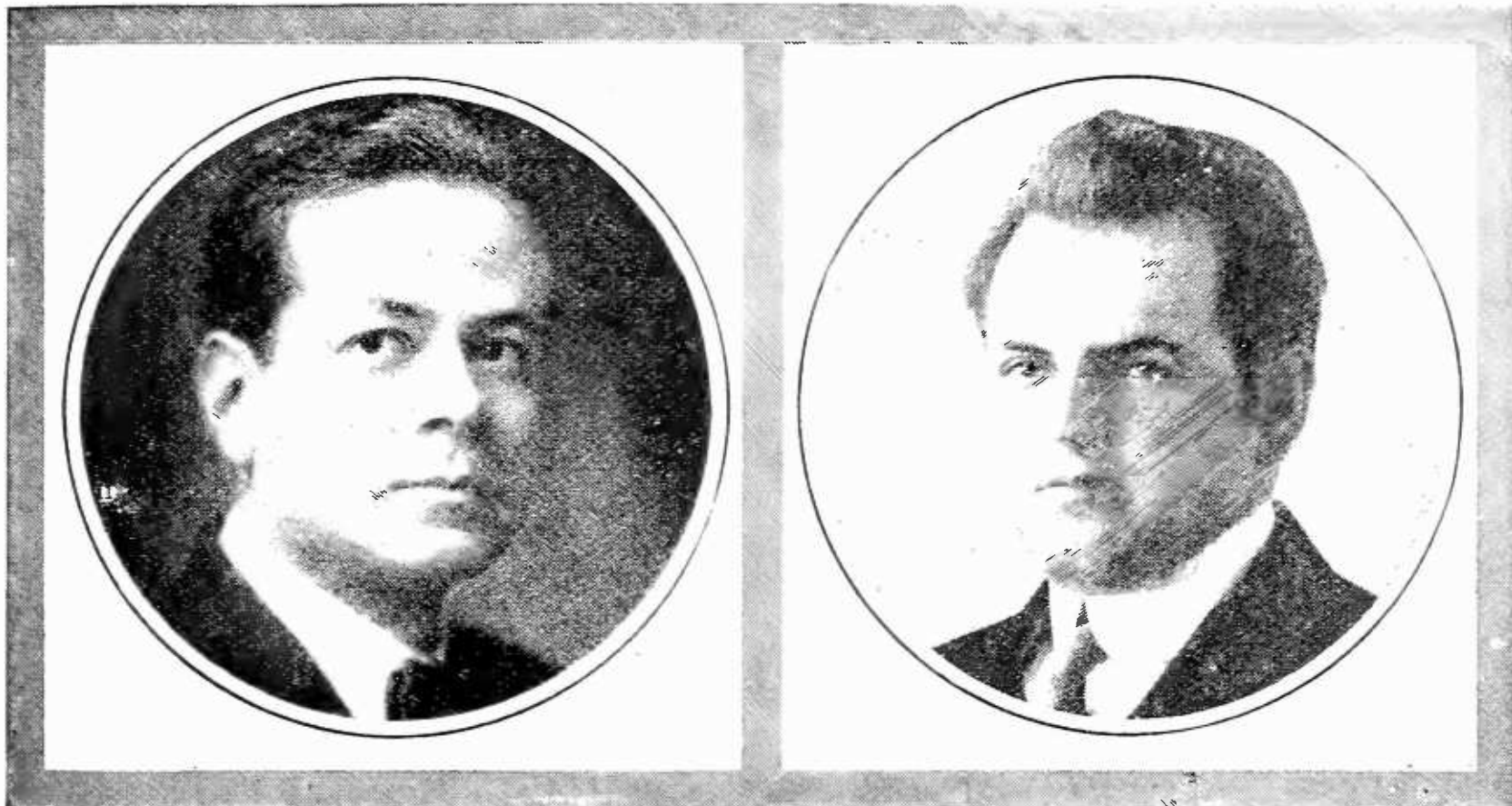

SIGNOR GUERRERO AND FERDINAND FILLION

Recently heard in joint recital from station WGY. Signor Guerrero is a South American pianist, now of the staff of the Toronto Conservatory of Music. Ferdinand Fillion, concert violinist, is also on the staff of the Toronto school.

orchestra, of more than one hundred members, is maintained chiefly for the purpose of giving young American musicians of recognized ability opportunity to keep in orchestral training so as to be ready for positions in the permanent symphony orchestras of the country when vacancies occur. Although American compositions are featured in the programs, an extended variety of the standard orchestral masterpieces are also played. In all, eighteen concerts will be broadcast, thirteen for adults, under the direction of Chalmers Clifton, and five for children, under the direction of Ernest Schelling. The remaining dates for the programs for adults are January 18 and 22, February 15, 19 and 28, March 22, 26, 30, and April 19 and 23. The dates for the children's concerts have not, at this writing, been announced, but they will be given at Aeolian Hall, New York, Saturday mornings during February and March, probably in alternate weeks. Thanks to the farseeing judgment of Franklin Robinson, executive secretary of the American Orchestral Society, the broadcasting of these programs has been made possible.

Also, there is the Eastman School of Music at Rochester, New York, that is making possible, through station WHAM, the hearing of much good music by owners of radio sets. The concerts of the Rochester Symphony Orchestra, operated in connection with the

Eastman school, are being broadcast through station WHAM. The schedule of dates for the remainder of these programs is: January 22, February 19 and March 19, in the evening at 8:30, eastern standard time; and the afternoons of February 26, March 5, and March 9.

This Eastman School of Music is likewise presenting chamber music concerts which are also being broadcast by WHAM. There still remain in this series the evening programs of January 20 and 30, February 27, March 9, and March 27.

The directors of WHAM have stated that these two series of concerts are broadcast this winter because last season when the experiment was tried of putting a few of the programs from each series on the air they proved by far the most popular feature the station had ever broadcast. Which is but another proof that the public, given a chance to hear or see the best in art, will quickly appreciate it.

Some Suggestions on Studio Etiquette and Management

SOME time ago we took pleasure in quoting in this department some comments on broadcasting received from Mr. Richard K. Morton, of South Boston, Massachusetts, who has himself been heard from various radio stations in the East. Now comes to hand another letter which so well

covers some of the questions that are continually being asked the conductor of this department. by people near and far. that Mr. Morton is again quoted.

Many listeners-in wonder why so little consideration is given to balancing radio programs. If there is an important psychology in the arrangement of concert recitals, articles in magazines, etc., there is a psychology in radio programs.

What can a radio lecturer do, if he follows the broadcast of a prize fight? Why, moreover, is there so little regard either for the psychology of the radio artist or the listener-in?

Take, for example, the tired listener-in who is furnished late at night with a lecture immediately following jazz!

While broadcasting from one studio, this was the situation which confronted me: the announcer had, at the last moment, scribbled data relative to my name, the title of my talk, etc. He was vigorously puffing a

cigarette in the well-padded and almost hermetically sealed studio. The air was hot, stagnant, stale. I had to stand and talk into a microphone which was only as high as my waist; the alternative was to sit in a cramped position at a small table. Fully twenty-five artists and visitors were in the studio. They made distinctly audible and belittling remarks relative to me and to my contribution.

Am I a hypocritical grouch when I ask if listeners-in want this type of situation to be endured by radio artists?

Numerous inquiries have come to the editor of this department, all couched in about the same form. "Do broadcast directors allow people in the studio while any one is broadcasting? I'm sure I can often hear other voices from the studio in addition to the one that is giving the number."

And many artists have said with emphasis after a first broadcasting experience, "Never again! There was a mob in the studio, and another mob running in and out. Imagine

trying to give a decent performance on a concert stage under such circumstances."

Note what Mr. Morton has to say:

It is beyond me to understand why so many stations still persist in allowing a full studio while a number is being broadcast. It is also beyond me to understand why they allow going into and leaving the studio during a number. Personally, I feel that

it is wrong for an artist to bring to the studio, for obvious reasons, a host of his admirers.

As for the question of requesting cards from the radio audience, I think it is very poor taste for a speaker to request cards relative to his own speech. Even announcers should make such requests with moderation. And why do listeners-in, when sending in cards relative to broadcasts, confine themselves to flattering but meaningless generalities? Why not give the artist genuine criticism, showing an intelligent interest in his

contribution? Why not be specific, discussing the item in a concrete, analytical style, which will stimulate the artist, give him suggestions, and call his attention to points of value to him?

The cards that are sent to radio stations are a good deal like the telegrams and telephone calls sent in during a program, than which nothing could be more tiresome or stupid. Fortunately, broadcast directors do not attempt to read to their listeners-in the communications they receive by mail. If they did—but perish the tho't!

Radio Vision Both Ways

SCARCELY a week passes without a story being published regarding the future of radio vision, if it may be called that. We are constantly being told that, ere long, we shall all be able to see as well as hear the radio speaker or musicians. We shall even be able to follow the games that, point by



Kossuth Wheeling

GEORGE BARRÈRE

Flutist of international renown and conductor of the Barrère Little Symphony Orchestra whose New York concerts this season are being broadcast by station WEAJ

point, are now broadcast, or to see the opera to which we listen at the receiving set, or the orchestra.

Will this predicted marvel work both ways? Will the broadcast directors be able to watch their listeners-in? It is to be hoped so. For the quickest and surest way to bring about the much needed reform in radio programs is for the broadcast directors to see how their programs are being received. Some of them would experience a tremendous shock.

Why They Say "Please Stand By"

HAVE you ever wondered why the broadcast announcer, when there is a wait between numbers, always tells you to "Please stand by"?

Why, "stand by"? That ancient boson's warning?

Mr. Rhodehamel, of station KGO, at Oakland, California, explains that this term and various others used by broadcast announcers, came into use in radio stations because nearly all broadcasting operators have been to sea as

ship operators. He states that, at KGO, the operators always refer to the floor as the "deck." Walls are spoken of as "bulkheads." Windows are called "ports." Operators do not work so many hours, they "stand watch." The book recording transmission and changes of apparatus is called "the log." The clock isn't a clock, but a chronometer, all rigged up in gimbals to take care of the swaying of the ship, in the regular little brown mahogany case.

Not all broadcasting stations are as nautical as this, but from every one of them you will hear the old call of the sea, "Stand by!"

There is a Demand for Education by Radio

THE lectures on music appreciation given Friday evenings at 7:30, through station WBZ, by Professor Stuart Mason of the New England Conservatory of Music, have been a pleasing diversion to some listeners-in and, no doubt, a source of much desired instruction to many more.

But, as these lectures, which are illustrated at



Thomas Coke Knight, New York

BERNHARD LEVITOW

And his Hotel Commodore Orchestra scheduled for 200 radio concerts from WJZ and WJY this season. They play much beautiful music and play it remarkably well



Whiting, St. Louis

RUDOLPH GANZ

Conductor of the St. Louis Symphony Orchestra whose Saturday evening concerts are being broadcast from station KSD. Mr. Ganz, in addition to his orchestral work, has long been among the world's noted concert pianists

the piano by Professor Mason, occupy but one half hour, he must feel, as do some of us who have studied the subject matter of the lectures during our years of musical training, that the time allotted him is so short he can scarcely touch his subject before it is time for him to stop. That he can get over as much ground each week as he has so far succeeded in doing shows well that he is thorough master of his subject. But, even so, such courses in music appreciation confined to one half hour a week cannot be other than superficial.

When radio has settled down to a constructive basis, instead of being, as now, chiefly a medium for light entertainment, these educational courses will take on a more important aspect. No doubt, broadcast directors would hesitate to put on a musical lecture that lasted an hour. They would see, in their imagination, thousands of impatient listeners tuning out to a more congenial attraction. Yet, they might also use their imaginations to realize that those who interest themselves in these educational courses would be more numerous if they thought that the paying of the fee of one dollar, for literature and examination papers, would include an hour's instruction weekly.

Perhaps, in time, we shall have certain broadcasting stations given over wholly to educational programs. If this day comes—

and is not such a thing plausible?—a course in musical appreciation, in literature, or any of the other educational subjects now put on the air, will be more thorough than is at present possible.

A Good Entertainer of Children

THE oh, so sweet, dearie-dovey children's entertainer is the most aggravating thing that comes over the radio. But when such an entertainer is good, that is to say, when he or she talks to children as if they knew something, then this program feature is a delight.

Such an entertainer is "Uncle Walt," of the Chicago *Tribune* station, WGN. He is an unfailing joy. He talks to the children as if they were his equals, and so they are. Who was it said that the only people for whom you have to write in words of one syllable are grown-ups? For children, never! Uncle Walt understands this. Have you ever heard him reading *Alice in Wonderland* to the children? And have you ever heard him sending up stars for them? If you haven't heard him sending up the stars you have missed one of the most beautiful features ever broadcast.

It really seems as if it is up to us listeners-in to devise some way of sending up a big star for Uncle Walt. Yet, upon second thought, that would be much like carrying coals to Newcastle. For Uncle Walt is himself a bright and shining star in the broadcasting world.

Musical Laughter

HERE is a semi-musical joke that came from station WEAJ. If memory serves rightly it was told by one of the "Happiness Boys," excellent fellows that they are.

"Did you hear about George going home just a little lit-up the other night? No? Well I'll tell you about it.

"His wife, she was awful mad when she saw him, and she says:

"What's the matter with you?"

"Syn—syn—co—pa—shun," says George.

"What?"

"Syn—syn—co—pa—shun.

"And what's that?"

"It's syn—syn—co—pa—shun."

"Well, his wife didn't say anything more that night. But when George came home the next night she says:

"Huh! I knew I was right last night about what was the matter with you. I looked that

syncopation up, and it said it means, uneven rhythm from bar to bar!"

That's a relief from jazz, anyway.

NEVER, even though the whole world adopt it, will this department ever refer to broadcasting as "radiocasting." Of all the unimaginative, hard-sounding, machine-like words invented, "radiocasting" is the most disagreeable. When it comes over the air. "This is radiocasting station xyz"—*à bas!*

IF DELILAH had jazzed "My Heart at Thy Sweet Voice," when she was putting over the treachery "stunt" on Samson, he never would have been shorn of his strength by losing his locks. For he never would have fallen for jazzful love-making.

SOME women's voices of beautiful quality have been heard over the radio lately, but almost without exception the slow tempo at which the songs were sung completely ruined them. There was the contralto who sang not long ago from WBZ's Boston station "When the Roses Bloom Again" and "Drink to Me Only With Thine Eyes." We heard a lovely voice, but it was quite impossible to listen to it because of the dragging interpretation.

FROM a WGY program:

Waltz, "Take a Look at Molly". Franklin

Research Talk, "The Metallography of Paint" (Courtesy Engineering Foundation)

Fox Trot "Jealous" Malie-Finch

Does any one except the compiler of this program know why a talk is put in such a place? Does even the program compiler himself know?

IF THOSE responsible for the mid-week services under the auspices of the Greater New York

Federation of Churches, broadcast from WEAJ, expect to further the cause of religion through radio, they will have to "pep up" some of the performances. We tuned in on such a whining performance of "Abide with Me" the other night, that we abided only long enough to tune-out. For consolation we listened for quite some time to the Night Hawks.

CHICAGO is one of the greatest music centers in the world, and in this country is ranked by all as equal to New York (and by some as that city's superior), as a place where the best music may be heard under the best advantages.

How, then, does it happen, that the music programs broadcast from Chicago are, with rare exception, not equal in quality to programs heard from some other cities of but slight musical reputation? Certainly, one of the Chicago stations can bring us something good.



Thomas Coke Knight, New York

MRS. CLARA E. BREAKEY

Lecturer on home economics at New York University, who gave a course on cooperative economics from station WJZ with such success that she seems to have nullified the contention that women are never as effective speakers over the radio as are men

Some Experiences With the Blind and Radio

BY CHARLES T. WHITEFIELD

WE FANS have got the impression, no doubt, that everybody in the United States knows about radio—at least, knows a little—but I have recently had some experiences which have caused me much surprise.

I live in a county which contains about 125,000 people, and in a moment of bravado I offered to provide all the blind people in the county with a suitable radio receiver, so that they might listen in to the concerts in New York and get the benefit of all the good things that were going on within a few hundred miles of the metropolis.

In such a large county I expected that there would be a hundred blind persons. Much to my surprise, after making every effort to find every blind or near blind individual, I discovered that there were only about twenty. Each one of these people I visited, and had some tragic experiences.

For instance, approaching a broken-down old house, with debris of all kinds spread in every direction from the front door, the old man who opened the door kept his foot carefully in possession of the opening so that I could not break in. When I told him that I wanted to give his son—a grown man of thirty or forty who has been blind for twenty years—a radio, he was very wroth. After some conversation he said that if I brought the radio machine, he would take it out in the backyard and chop it to pieces.

Here the conversation would naturally seem

to end; but I asked him if I could not see his son, who still at eleven o'clock in the morning was lying in bed with nothing to do except to think of his own misery. The son took a more cheerful point of view, and said that he had been told about the radio, but had never actually listened to one. After some persuasion I got the old man to agree that if I would send a machine, with a Boy Scout to put it up, he would allow it to be introduced; but

he reiterated a dozen times that he wouldn't pay a cent, and I had the greatest difficulty in convincing him that I was not looking for money.

Some of the other cases were not quite so successful as this. For instance, I visited an old man who had caned chairs and done other things, but in his weakness had had to give up even this occupation. He was taken care of by two or three sisters who lived in the house with him, and I thought it was an ideal place for a receiver. After broaching the matter with

as much delicacy as I knew how, he made a violent speech to the effect that he had already heard the radio once, and he never wanted to hear it again. I still urged that perhaps this radio was better than the one he had heard and that his sisters might enjoy it with him; but he ended up by stamping his feet and saying that he was prejudiced against the radio and would not have one. I hope to live long enough to go back with a portable set and make a convert of him, but the incident is closed for the present.

Is It Not True

That most of our happiness comes from making others happy? Here's a chance for you to do a great deal of real good for the blind in your neighborhood. The accompanying article describes how the blind in a certain county were made more happy by the gift of a radio set. The gift was made complete, with batteries, headphones, and loud speaker, and the local Boy Scouts agreed to install and inspect the sets monthly. There is much that radio can do for those unable to get out in the work-a-day world, and it is good to know that concerted effort is being made to see that the wounded veterans have receivers. This latter is being handled by the Sun-Roxy Fund in New York. Another fund now being raised nationally by the American Radio Association, 50 Union Square, New York, is to buy radio sets for every blind person. The Association will undoubtedly welcome independent aid of the sort outlined here.—THE EDITOR.

Some of my visits were quite inspiring. For instance, one man who had been blind for about seven years was extraordinarily cheerful, and he told me that until he adjusted himself to his new life he was very, very unhappy. Finally he convinced himself that a man could live and take an active part in life though blind; and when he had done this he became happy, and has been happy ever since. He had accomplished the extraordinary feat of building himself a house, mostly with his own hands and the help of his wife. He was an enthusiastic radio fan, but had to go a mile and a quarter to the house of a friend when he wanted to listen in, and this was difficult because he had to have some one take him. Naturally, the idea of having a machine for himself was a source of great joy to him.

Three or four blind people I found had a radio, and all of them were receiving the greatest benefit and enjoying it hugely.

HOW THE SETS WERE INSTALLED

AFTER rounding up all the people whom I could find, I enlisted the help of the Boy Scouts to put up the machines and take care of them. We selected a very simple type of machine, some with a pair of head phones, and some with loud speakers. The cost of the machine, batteries, and tubes was about forty dollars apiece. The Boy Scouts put them up, of course without charge, and are expected to make a monthly inspection of each blind person's radio and report the conditions.

Although there were some blind people who

were unwilling to have anything to do with this new-fangled machine, in almost every case I persuaded them that they would get pleasure. The humorous side has been their fear that it would cost them money. Without exception, they showed the greatest apprehension lest they would be led into something which would bring them financial responsibility. When I told them that I was doing this for pleasure, they did not accept it with any degree of cordiality, feeling that there was something behind which they did not understand; in fact, that something was being put over on them.

The experience of visiting these people, which I apprehended would be an unpleasant job, was quite the reverse. Enough people were very grateful to make the whole enterprise worth while, and I feel sure that the success of the thing is beyond peradventure.

Among the readers of RADIO BROADCAST there must be thousands who could do this in their local town or county. My own experience has proved that it has to be done personally and cannot well be done by somebody hired for the job. I cordially recommend the idea to anybody who wants to add comforts and pleasure to the lives of blind people. If a sufficient number of people could be got together to cover the country, the load of pain and suffering would be tremendously decreased.

For the practical reader I may say that the machine we have found best adapted to the purpose is of the reflex type.

"AS THE BROADCASTER SEES IT"

IS THE title of an interesting series of articles by Carl Dreher, the first of which will be a feature of this magazine for March. What the broadcaster is doing, how he does it, and what he is thinking of while he is doing it, will form the subject matter of this series which should interest those both active and passive in radio. "As the Broadcaster Sees It," will give the broadcasters—engineers and program directors—a place where they may exchange ideas. Listeners will be able to "look at" broadcasting from the inside. Mr. Dreher is chief engineer of one of the best known American broadcasting stations. These articles will not supplant but complement "The Listeners' Point of View."

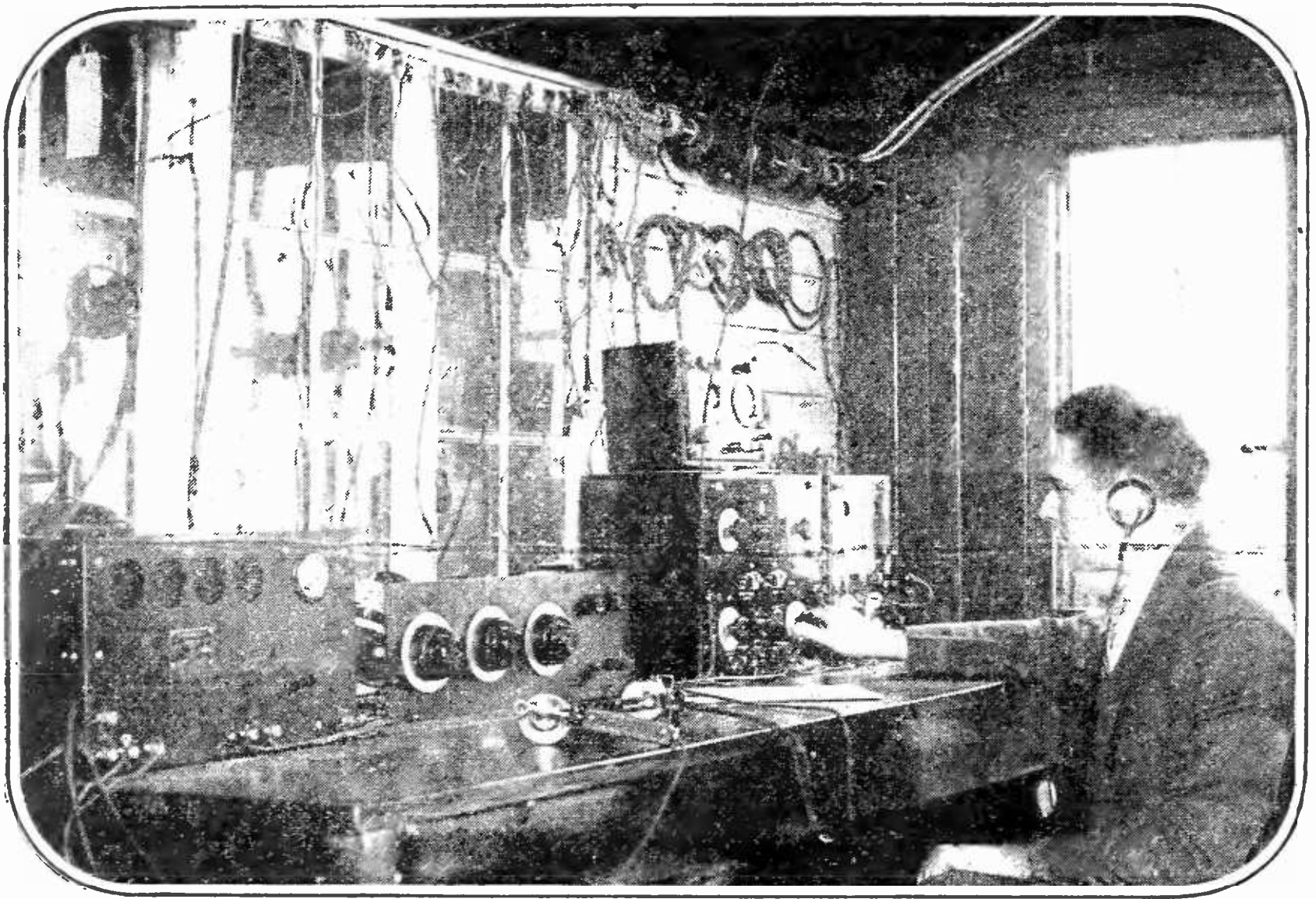

CHECKING RECEIVERS FOR THE INTERNATIONAL BROADCAST TEST

A corner in the RADIO BROADCAST Laboratory which shows some of the apparatus employed in the tests. At the left is a low powered radio telephone transmitter, presented by the Radio Corporation, next to it is a Roberts short wave receiver, and beyond that, a Kennedy long wave set is being operated by John B. Brennan, editor of the Grid. Signals from all the European countries participating in the tests were logged at the laboratory through which the broadcast activities of two continents filtered during the test week

THE MARCH OF RADIO

By

J. J. Morecroft
Past President, Institute of Radio Engineers

The Great Success of the International Tests

WE CAN record a well-merited success for those who conceived and executed the international radio broadcast tests of 1924. It is only a short time ago that Mr. Paul F. Godley, one of the most skilled radio operators in America, first attempted to hear a low-powered, short-wave set span the Atlantic. It was really a wild idea at that time, and one for which a successful outcome had been predicted by practically no one.

He used a many-tubed super-heterodyne working on a specially constructed antenna, and was finally successful in picking up code signals from several American amateurs. Mr. Godley's receiving apparatus was set up in Scotland.

During the test just come to a close, thousands of American radio fans heard many of the low-powered, short-wave European stations. When one compares Godley's test with those of 1924 one cannot but believe that radio

communication is striding forward rapidly. The successful listeners during the test were not skilled amateurs. They had sets using a half or a third as many tubes as did Godley's, they had ordinary short antennas, and in some cases loops only, and they received radiophone signals, whereas Godley received dot and dash telegraph signals. This latter fact is of much more importance than one might think; the same amount of power used for telegraphing as used for telephoning is good for possibly twice the distance of communication.

It is not easy to conceive of just what these long-distance tests mean from the standpoint of power. A station rated as 500 watts probably radiates about 100 watts of power, and the energy thus thrown off spreads out in all directions. Much of it is radiated up 50 or 100 miles and there is partly dissipated in the semi-conducting atmosphere and partly reflected down again to the earth. Part of the energy is absorbed by buildings, and even by vegetation on the earth's surface, which is evidenced by the fact that the signals which travel over land be-

tween two stations are by actual measurement only about one third as strong in summer as in winter.

In spite of this dispersion, absorption, and reflection, there is still left sufficient power after a voyage of 4,000 miles to give an intelligible signal to the radio listener. Imagine a 500 watt incandescent lamp burning in France, Italy, or England, being visible to thousands of observers in our country! Imagine communication being carried on between those countries and ours by a blinker code worked on the lamp. In trying to imagine such a feat remember that our best lighthouses, having lamps of 100,000 candle power or greater, are visible at most over perhaps 50 miles. One feat which has been accomplished in radio is still waiting to be solved in the realm of optics, that is, the magnification of the received signal. If we had some apparatus through which to look, which would do the same thing to the light waves as our amplifiers do to the radio signal, then possibly the 500 watt lamp in Europe would be visible in America. Unfortunately, it is

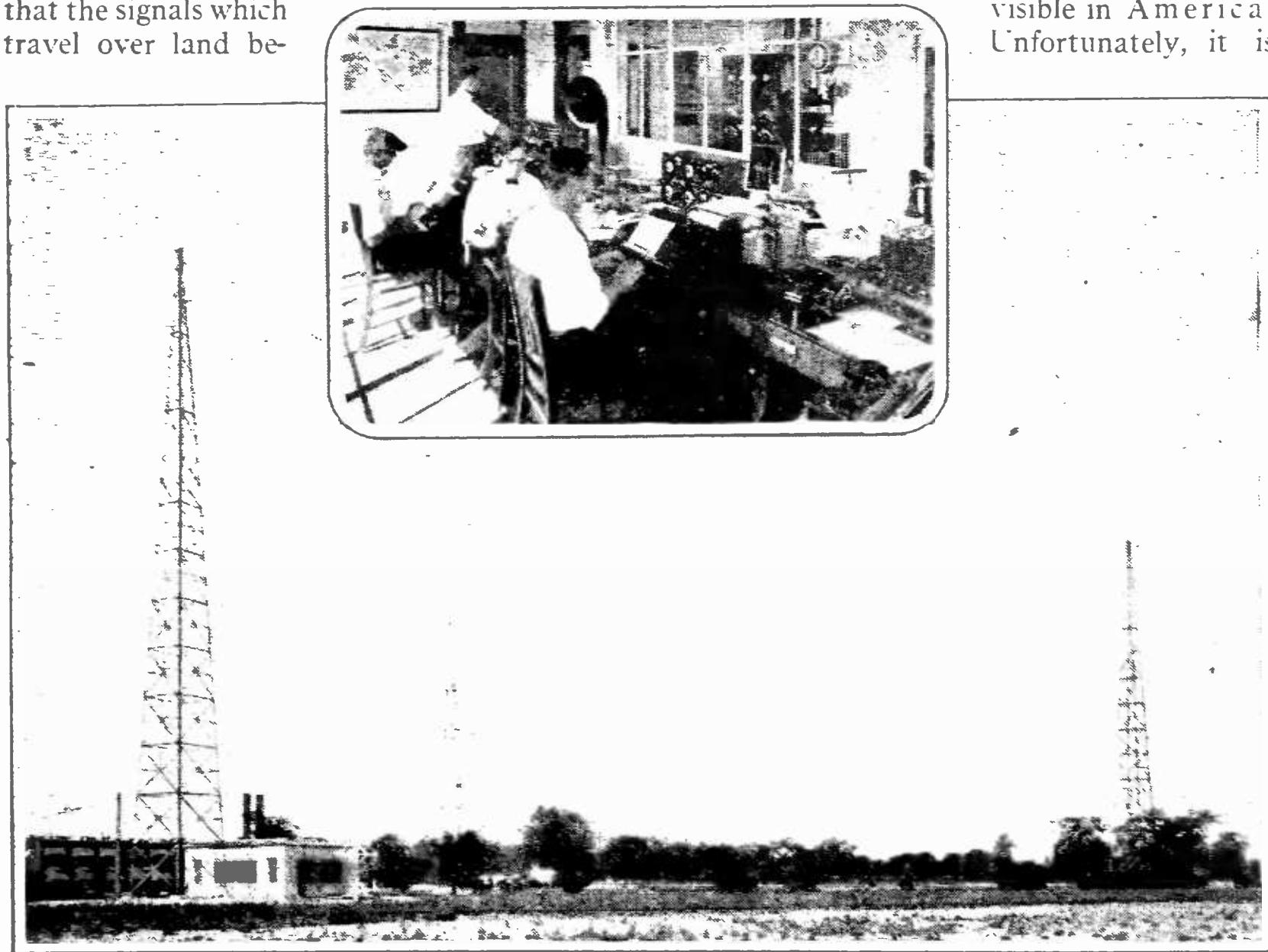

HENRY FORD'S RADIO PLANT

At Dearborn, Michigan. The three towers of the 1000 watt station WAW which operates on 1713 meters with Ford stations at Springfield and Jackson, Ohio. The four lake carriers of the new Ford Fleet are in constant communication by radio with the home office, wherever they may be on the Great Lakes, which can be a maximum of five hundred miles distant. More than 400 messages a day are handled by the operators, shown in the insert

not possible to amplify light as yet. Radio has been able to march right away from the older branches of science in this respect.

Besides giving a thrill to the broadcast listeners who heard the transatlantic stations, these tests, planned and executed by RADIO BROADCAST, have a real educational value. Few listeners to-day really appreciate the true status of radio transmission. If a signal will go 1,000 miles, why not 2,000? No reason at all, and it actually does go 2,000 miles, or 10,000 miles for that matter. Every day the signals from all the European stations are racing past our receiving sets. Just because we don't hear them is no evidence that they are not there. The signals are there, but so are all the other electrical noises set up by electrical disturbances of all kinds, artificial as well as natural. Every time a trolley wheel jumps off the wire in Chicago a radio signal is sent to New York and beyond, and every elevator which starts or stops in New York reciprocates for the benefit of Chicago listeners. Every electrical storm in the Gulf of Mexico splashes radio signals of all conceivable frequencies over the whole world, and the little regenerative receivers in Baraboo and Chappqua add their share to the Babylonian chatter resulting in what we call interference, static, or plain "noise."

And here we add the telephone engineers' motto on transmission, a motto which is of as much significance to the listeners as to the engineer. "Don't let your signal get lower than the noise or you'll never find it again." Now the reason we do get European stations during these tests and not at other times is because ordinarily the noise level is higher than the signal and there is no set yet made which can reach down into this mess of noise and extract the signal we are looking for. So we know now that the way to hear Europe is to lower the noise level (at least insofar as it is due to artificial causes) and hope the natural noise is not too loud. Another way is at once evident to us, that is, to raise the signal strength by putting more power into the sending station—this is probably the real answer to transoceanic radio phone transmission. Raise the signal level a hundredfold, then the amount of noise we ordinarily have to-day will not be able to submerge it.

Government Monopoly of Radio Is Wrong

IN A recent talk before a meeting of representative business men, Professor Pupin, known to scientists because of his contributions to alternating current theory and

practice, and to the general public because of his autobiography *From Immigrant to Inventor*, expressed his views on governmental control of technical developments and industries. In view of a recent cable dispatch from France indicating a tendency in that country to control radio by strict governmental supervision, Professor Pupin's views seem especially timely. Besides being a scientist of a high order, he is known by his friends to be of sound business sense, having reasonable and well-founded views on the important questions daily confronting our country.

The weakest point in democracy has always been the lack of appreciation of expert knowledge. Railroads, telegraphy, telephony and radio-broadcasting, electrical lighting and the electrical transmission of power are certainly public utilities, but the intelligent people of the United States will never consent that these things, requiring an enormous amount of expert knowledge, be placed under government ownership. The machinery of our government or of any other form of government known to man to-day is utterly incapable of handling technical problems, which require the highest type of training applied to the highest type of intelligence.

All of these public utilities are full of complex technical problems which cannot, and never were intended to be, handled by any government. In Europe we see that where there is governmental ownership, the utilities are being run at heavy deficits. And only recently Mussolini has said that he wants to get away from government ownership and adopt the American system.

In the light of this opinion, it is apparently an unwise step which is being fathered by Pierre Robert, Under Secretary of State for Posts, Telegraph, and Telephone. He recently announced in the Chamber of Deputies that he believes that radio broadcasting should be organized as a government monopoly. He proposes to submit a bill to the Chamber at its present session and will urge its adoption. It seems strange that Professor Pupin, who knows his Europe much better than most of us, used it as a striking example of the futility of expecting public utilities to be operated successfully under governmental control.

We learn also that the Minister of the Interior has organized a special "listening-in" service to be operated by police headquarters to insure that radio broadcasting shall not disseminate information detrimental to what he considers the "country's good." Propaganda of all kinds will be taboo, and we learn that the police will try to prevent the "transmission throughout the provinces of information on daily market conditions and prices, as essen-



tial products would thus be held up by the producers for the most favorable terms, thus increasing the cost of living." Here in the United States the farmer is continually urged to utilize the radio dispatches of the Department of Agriculture and other government bodies which send out market conditions specifically to enable him to market his products most profitably. It is difficult to understand the French attitude. Isn't the farmer entitled to whatever help radio can give him? Certainly no government official in the United States would boldly declare, as did the French minister, that he didn't mean to help the farmer market his wares as profitably as possible. It seems that there must be no "farmer vote" to worry about in France as there is in America, as most of our politicians seem to think.

Photographs Across the Sea

ONLY a short time ago we commented on the excellent transmission of pictures from Chicago to New York over the wires of the American Telephone and Telegraph Company and also on the successful attempt to send them from Washington to Baltimore by a radio channel. About the same time that occurred here, in France M.

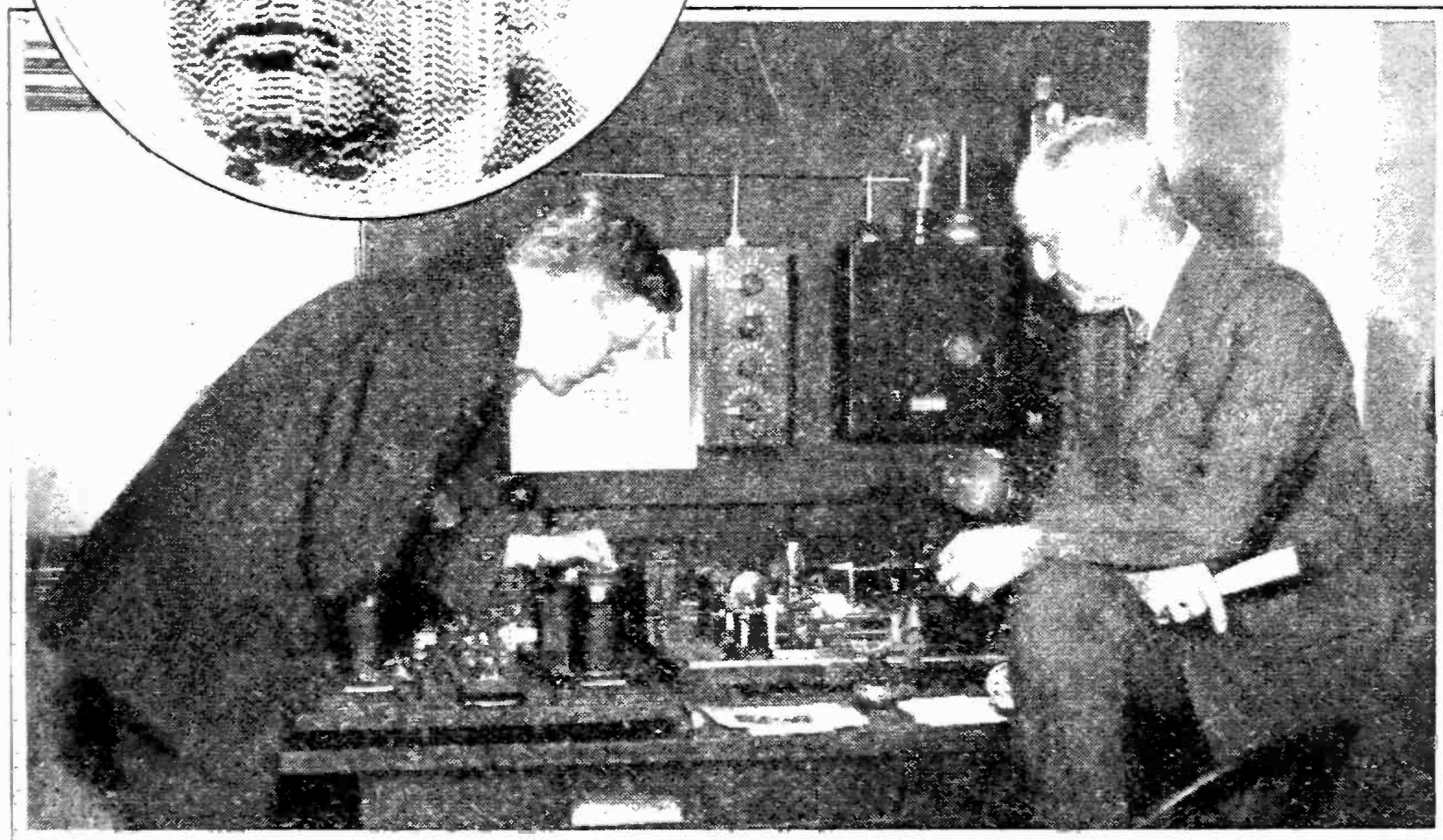

FACES ACROSS THE SEA

Became a reality when engineers of the Radio Corporation of America and the British Marconi Company succeeded in transmitting photographs by radio from London to New York. The system was developed by Capt. R. H. Ranger of the Radio Corporation. The top photograph shows Capt. Ranger, the round insert is a photograph of Ambassador Kellogg, one of the first to be transmitted across the Atlantic. The bottom view shows General Harbord, president of the Radio Corporation (right) and Capt. Ranger

Bélin announced the successful conclusion of his efforts to transmit pictures by radio. Now we have pictures across the Atlantic. The Radio Corporation of America has succeeded in sending some quite recognizable portraits from Carnarvon, Wales, to Riverhead, Long Island. High power is used so that the signal received in America is reasonably large compared with static disturbances, and in this way the blotchy appearance which is sometimes caused by atmospheric disturbances has been practically eliminated.

The general scheme used is the same as before: light from (or through) the portrait to be transmitted falls on a sensitive photoelectric cell. The action of this cell controls the intensity of the signal sent from the transmitting antenna. The light beam used is very small (only about one hundredth of an inch square) so that it covers only a very small

part of the portrait at one time. By moving the picture past the light beam back and forth and having quite similar receiving apparatus actuated from the received signal, a picture is formed by packing together a series of shaded lines. It takes about three seconds to draw one line completely across the picture, and as there are about 100 lines per inch it may be figured out that to transmit a picture about three inches square requires twenty minutes.

Fixing the charge for picture service by the amount a station could earn in a similar time by transmitting telegraph signals, each picture would cost about \$50. Most of us will evidently send our pictures by mail for quite some time to come, but newspapers may well use this picture service. The same apparatus can be used for sending the written or printed word, and it may turn out that, with the im-

provements which are sure to come, one can send a message faster by this photographic scheme than it is by the present dot and dash code.

It is not quite clear from the announcement made by the Company just what its engineers have contributed to this photograph transmission development. Practically the same process as that outlined has been used before for picture transmission, but it is quite possible that valuable additions to the progress of the art have been made in synchronizing the sending and receiving apparatus, and in eliminating the blotches caused by atmospheric disturbances. After the transmission has once started, it is essential in any

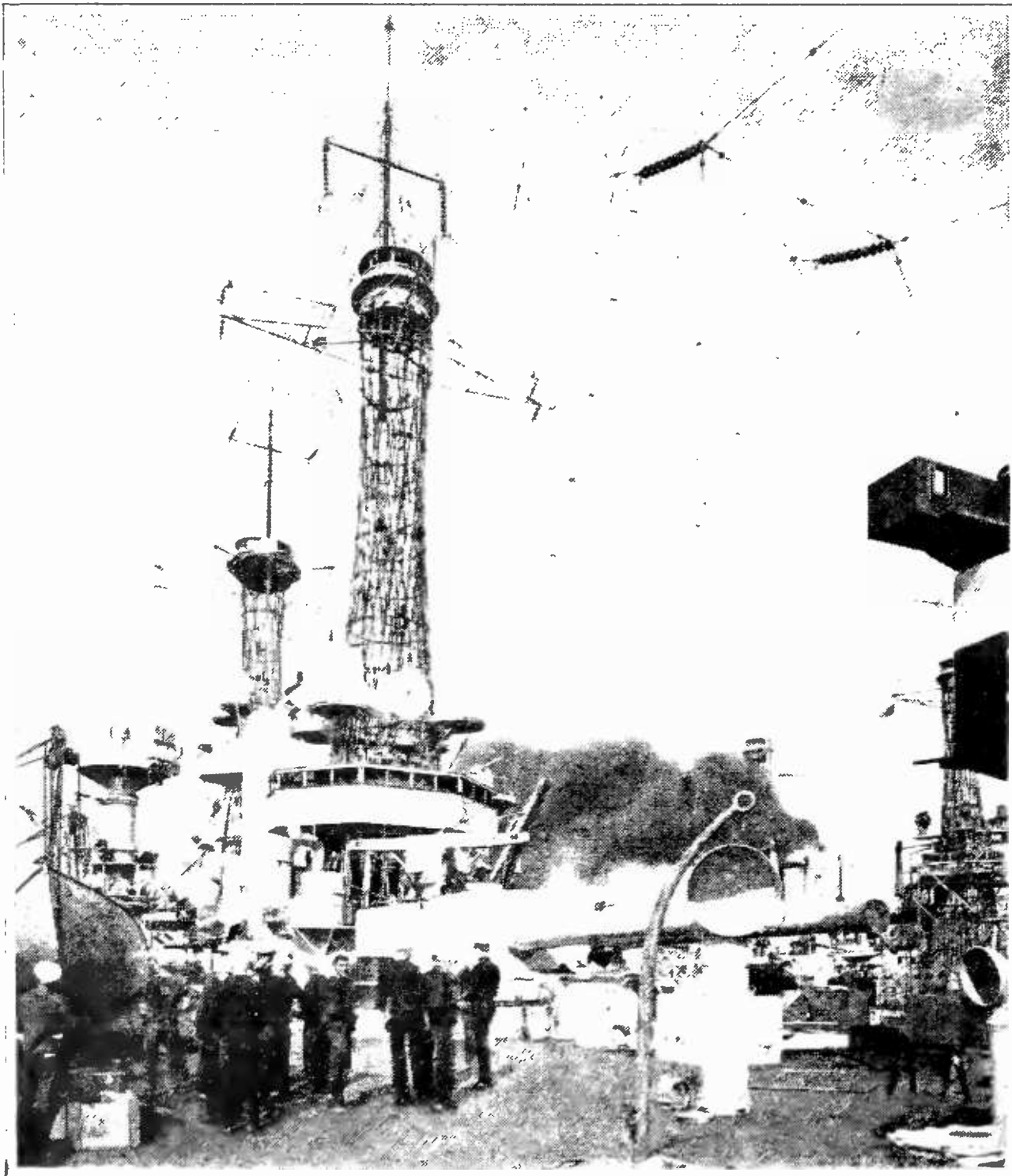

THE U.S.S. "TEXAS"

Showing the elaborate radio antenna system, which is used to dispatch the very considerable radio traffic necessary on practically every naval vessel

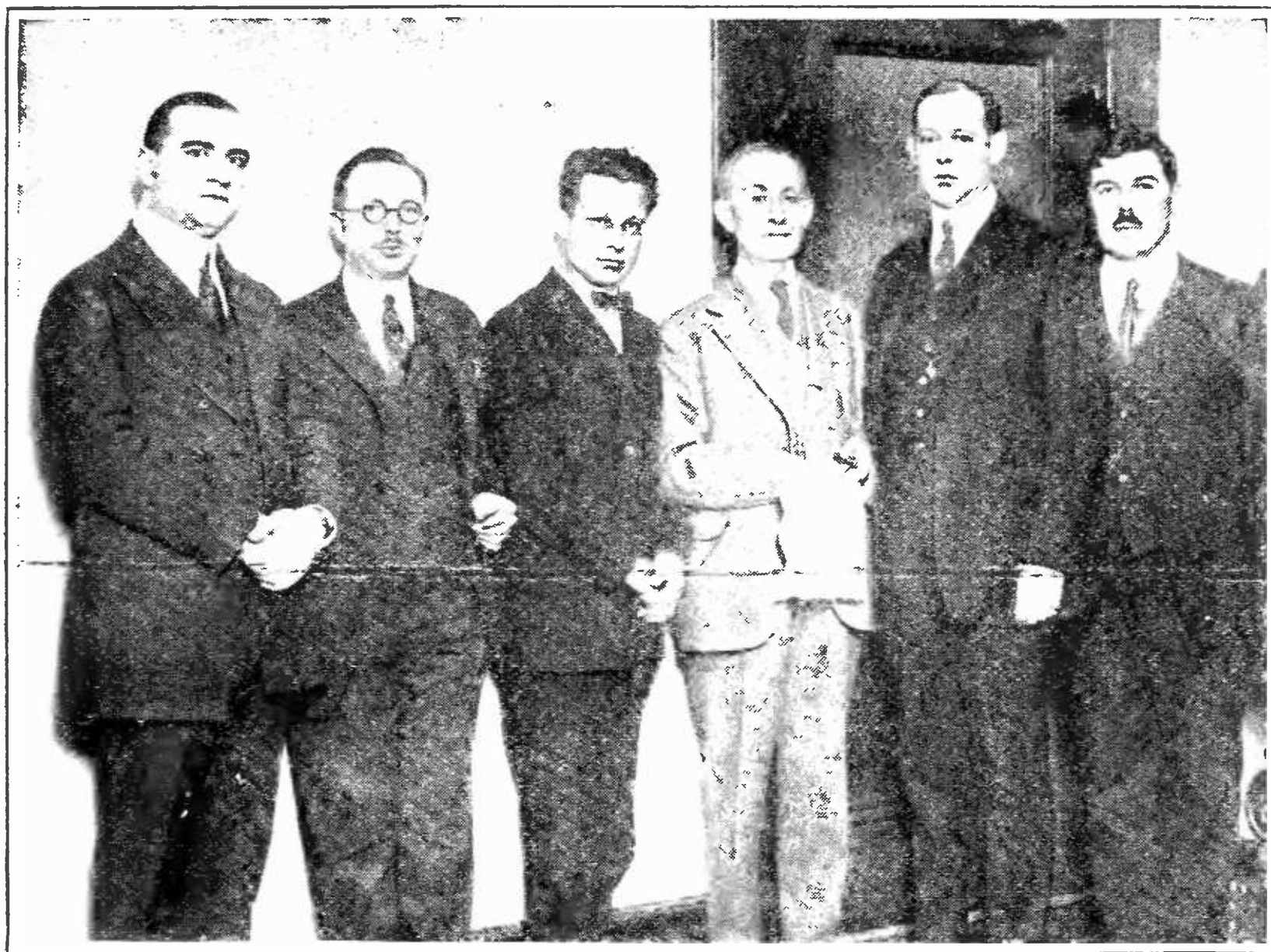

PROMINENT FIGURES IN THE RADIO WORLD

In the group, from left to right are, Prof. Alfred N. Goldsmith, past president, Institute of Radio Engineers, and chief broadcast engineer, Radio Corporation of America, John V. L. Hogan, consulting radio engineer, Prof. J. H. Morecroft of Columbia University, another past president of the Institute of Radio Engineers, Philip Torchio, L. W. Chubb, and Prof. L. A. Hazeltine, Stevens Institute of Technology to whom the patent on the neutrodyne receiver was granted

of these schemes that the sending and receiving drums run in exact synchronism, and to do this when 3,000 miles of ocean separate the two, is quite evidently a real task. Undoubtedly we shall later get a better explanation of the new features of the Radio Corporation's scheme, which shall show how the requisite synchronism of sender and receiver is maintained in the radio channel.

The Radio Compass Can Guide Aëroplanes

A REPORT from Washington, evidently emanating from the Army Air Service, tells of "the first practical test" of the radio compass as an aëroplane guide. We were under the impression that the radio compass was quite successfully used during the War to guide aëroplanes, but now it appears that some new developments make the Signal Corps rise and assert that a real advance has been made. Two special radio

compass stations have been established, one at Dayton, Ohio, and the other at Moundsville, West Virginia. By means of the signal sent out from these stations, Lieutenant G. W. Goddard was able to "keep in a bee-line," as he says, between the two fields even though the day was so foggy that he could not get his bearings from well-known landmarks.

The transmission system was such that when he was on a straight course he heard only dashes in signalling, but when he got off the course the signal was changed. If his plane was veering to the left he heard a dash and dot repeated at ten-second intervals, but if he was going to the right of the proper course he heard a dot and a dash repeated at the same interval. By thus correcting the direction of his flight until he heard dashes only he knew that he was directly in line with the station toward which he was trying to fly.

One who has not been up in an aëroplane cannot appreciate the difficulty of getting radio signals in the cockpit. Many times we

ask some one in the house to keep quiet when we are trying to pick up a distant station. Even a low-pitched voice in the same room gives quite appreciable interference. How is it when the air is rushing by the listener at the rate of 100 miles an hour and the guy wires all singing notes of their own and the 150 horsepower motor exhausting right at his side with no muffler at all? The combination of noises is as bad as that in a boiler shop, if not worse.

To overcome this excessive disturbance, the radio listener must wear a padded helmet, in the sides of which are fitted the ear-phones. It is remarkable how much noise half an inch thickness of leather and felt can shut out. The rushing air becomes quiet and even the roar of the engine exhaust becomes a low hum. Of course even with the best helmet obtainable one needs a pretty strong signal for reasonable audibility, considerably stronger than is required by the ordinary listener. To assist the helmet in eliminating engine noises, long exhaust pipes were fitted to the engine of the test plane, so that the exhaust actually took place behind the cockpit, whereas generally it is right beside the pilot.

The antenna used was a long trailing wire hanging through the bottom of the cockpit and held reasonably vertical by a heavy lead weight. The general scheme used during the War was to have a loop antenna on the plane and get compass bearings as a ship does today.

After landing at the end of his successful flight Lieutenant Goddard said that it "had not been necessary to keep an eye open for landmarks at all." The radio signals enabled him to find his way directly to the station which was his destination.

In the same line of radio's progress we read with interest the report of George R. Putnam, Commissioner of Lighthouses of the United States. His department, we learn, now has twelve radio fog signal stations scattered along the coast and is establishing new stations as fast as funds permit. Commissioner Putnam says that this country leads the world in this form of relief. We were the first to give fog signals successfully and now have more of such stations than all of Europe put together.

Too Many Went to Fights by Radio

IN GENERAL, radio is praised for the success with which it disseminates news and entertainment, weather reports for the navigator, market conditions for the farmer,

music for the dance party, and football narratives for the college alumni or sports devotees. Football games, especially, have been well broadcast. An announcer like Graham McNamee performs his task so well that we can quite clearly visualize the mud-covered combatants as they slosh around through the mire of their battlefields. Judging by the newspaper reports of the attendance at these games, which at times have been as many as 100,000 for a single contest, one may safely come to the conclusion that football broadcasting has not seriously interfered with the gate receipts.

Another line of sport has apparently not fared so well as a result of radio's publicity. Tex Rickard, who makes a very good living by matching prize-fighters, has just put radio on his own Index. For the past three years bouts have been fought before the microphone so that the cheers and jeers, the gong, and even the thud of blows could be heard by the radio listener. And so vividly has radio portrayed the fight that many have preferred to stay at home, where there was no admission to pay, and no crowd of a hundred thousand through which to mill. So Mr. Rickard has decided that hereafter radio and he shall part company; the fight fan who wants to see two human beings who consent to batter each other for about \$1000 a punch will have to go to the scene and contribute his share of the gate receipts.

How Electrons Are Heard

IT IS only a few years ago that scientists dared to venture the idea of the electron, for before that the idea of the molecule and then its small comrade, the atom, had certainly stretched imagination to its apparent limit. For example, in a piece of cubical copper about one half inch on an edge, there are one million million million million atoms. To make a row of copper atoms one inch long, about two hundred million of them would be required. Imagine then the intrepidity of the scientific worker who dared to announce the existence of particles much smaller than the atom, so small that it takes one hundred thousand of them to make a mass equal to that of one copper atom. Gifted with a powerful imagination must be the worker who deals with electron phenomena, and especially is this true of the research worker who is going to find out new facts about the behavior of these infinitesimal particles of electricity.

It might be thought that particles as small as the electron could be dealt with only in the imagination, that measurements as to their size, velocity, quantity of electricity, etc., could not possibly be made. Yet this is far from the truth. The mass of the electron, and its size and electric charge, are known as accurately as is the length of a yard stick. Measurements of the electron carried out by independent methods agree with each other to better than 1 per cent.

Professor Millikan, when at the University of Chicago, carried out some remarkable experiments on electron measurements. So important were his results regarded in the scientific world that he was given the Nobel Prize. Millikan sprayed oil into very small drops, so small that they were nearly stationary in the air, even though free to fall. Some of the drops he used fell only one quarter of an inch in ten seconds, so little did the force of gravity attract them. A very powerful microscope was required to see them; in fact, the drops were never seen as such but appeared like the dancing circles which appear if one presses his eye-ball too severely. By having these drops of oil between electrically charged plates it was possible to make them stop falling or even move upwards if the drop-

let happened to be charged electrically. Now if electrons were produced in the space where the oil drops were being observed, one would occasionally attract itself to an oil drop, which would then immediately change its motion. By observing the change in motion and knowing the size of the drop (by other experiments) the charge of a single electron could be computed. Occasionally an oil drop suddenly changed its motion twice as much as did the others. This meant to the observer that two electrons had simultaneously attached themselves to the oil drop.

So by these remarkable experiments of Millikan's the electron was almost observed in motion. Now the electron is being heard! Dr. Albert W. Hull, one of the best-known research workers of the General Electric Company, announces that by apparatus which he has perfected it is possible actually to hear the electrons which fly across a vacuum tube. When they strike the plate of the tube they set up oscillations which, if sufficiently amplified, can be heard. Of course the amplification required is enormous, so great that if it were tried with the ordinary unshielded amplifier outfit, the noise due to atmospheric electricity would swamp the noise due to electron bombardment. By working inside a metal cage,

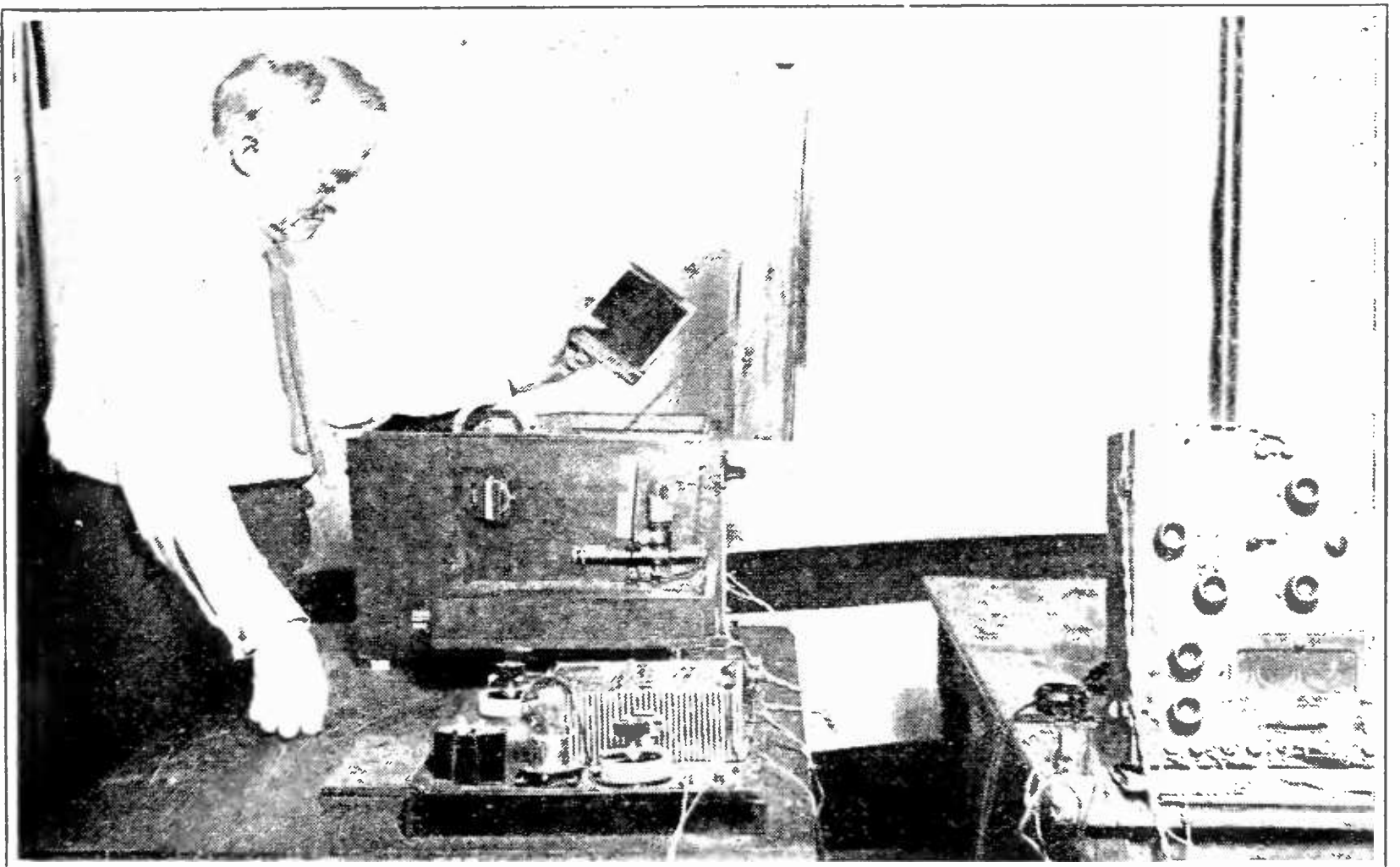

C. FRANCIS JENKINS

A radio investigator of Washington who recently was successful in transmitting photographs by radio from Anacostia, Maryland to Medford Hillside, Massachusetts on a wavelength of 746 meters. The photograph shows a laboratory set up of some of the inventor's apparatus at Washington

however, the listener is reasonably well shielded from extraneous electrical disturbances, and it is with such an arrangement that Doctor Hull and his co-worker, Prof. W. H. Williams, announced that they now hear the bombardment of the plate which is set up by the billions of electrons which every second pass from the filament to the plate of the ordinary radio triode.

Broadcasting Invades the Philippines

IN THE last session of the Filipino legislature a bill was passed granting a franchise to the Radio Corporation of America and two other concerns for the operation of radio broadcast service in that province. Governor Leonard Wood has just signed the bill, so that probably within the



OLD SOW RADIATOR

I know an old pest who be-clutters the air,
 She has many children—she has 'em for fair;
 She gives squealing lessons to all her young brats—
 (For sharp oscillations, they have it on cats.)
 A selfish old hag—with the sharpest of voices,
 In spoiling our concerts she gayly rejoices;
 Sing ho!—for a law to put her on the "skids—"
 And listen, dear fan—don't raise one of her kids!

—Drawing and verse by W. R. Bradford.

year the Philippines will have their local broadcast channels and occasionally the listeners on these islands will undoubtedly pick up messages from other lands.

Locating the Broadcast Station

IT IS now about two years since the first systematic measurement of radio signals was attempted and carried out. Where evidence about audibility and interference is obtained from untrained, observers as was first done, but little progress in radio transmission development is possible. Real knowledge of radio conditions can be obtained only by making measurements with instruments which can actually be read. It cannot be obtained by comparing the observations of two listeners having no other evidence than that given by their ears.

The next step in radio transmission investigations, after portable receiving apparatus had measured the signal strength in all directions from a fixed transmitting station, was to move the transmitting station itself to compare its performance under different conditions. It is probably true that to serve a large city and its suburbs, a transmitting station should not be in the city itself. If the transmitting station is in the middle of a group of steel buildings, practically all of its energy is absorbed in the immediate vicinity of the station and thus wasted. Much better service would probably be furnished to the city dwellers if the station was located in the country, possibly twenty miles or more away, in the open country where the absorption is comparatively small. Such a location must have good grounding facilities, and therefore actual trials of the location are always advisable before a station site is determined.

Station WJAZ of Chicago and vicinity has been doing just this thing lately. Their 100 watt transmitter, mounted on a truck, has been operated in various locations around Chicago and now a compilation of the data obtained by variously placed receiving stations around Chicago will permit the logical

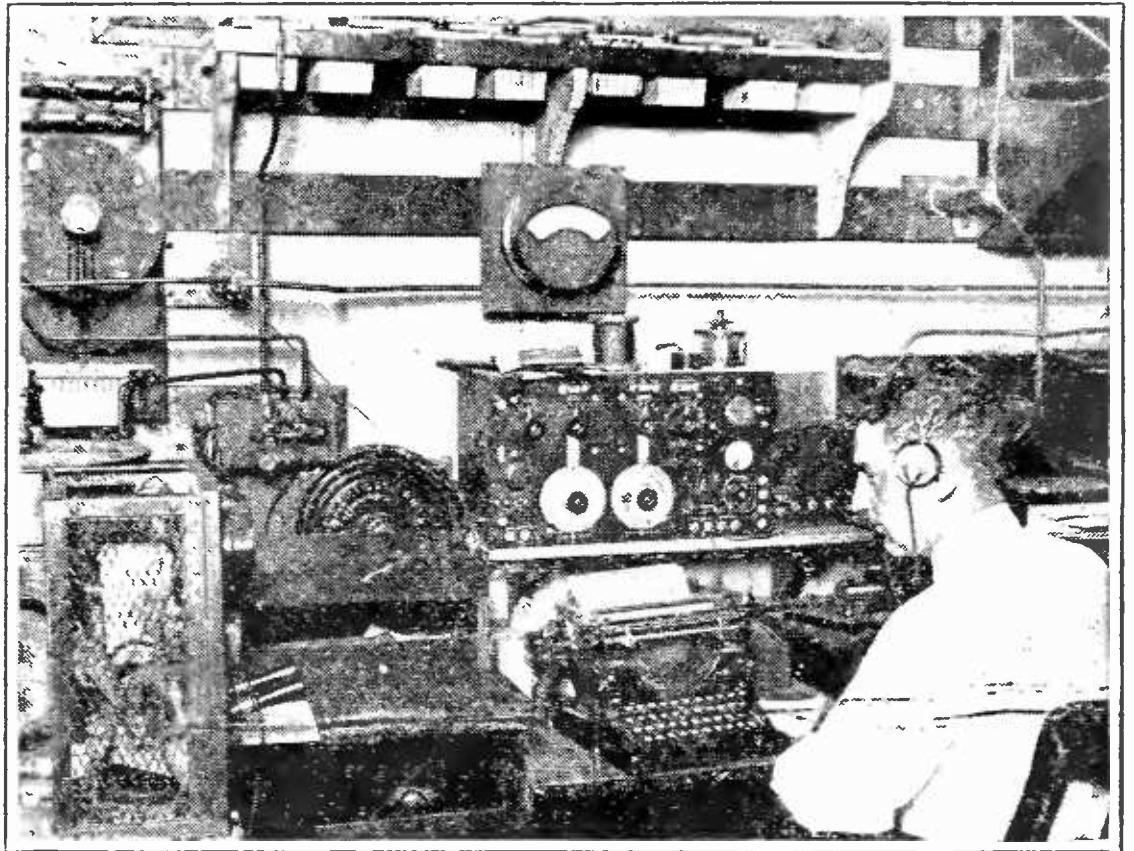

RADIO IN RETAIL MERCHANDISING

The radio telegraph station WHI at the New York store of John Wanamaker. The Philadelphia and New York Stores carry on a great deal of traffic which was formerly handled by telegraph, letter, and long distance telephone. A five kilowatt arc is used, transmitting on a wavelength of 1700 meters. The operator in the photograph is Douglas Smith, manager of the radio department at New York

selection of the most suitable location for a new broadcast station.

A German Broadcast Station on a Mountain

THERE are indications from Germany that radio is progressing there, even if not at the rapid pace it has assumed in our country. At Lake Kochelsee in Bavaria a station is being erected which, it is claimed, will be the most powerful in Europe. The antenna will extend along the side of a mountain from the summit to its base, where the station is being erected on the shore of the lake. This will give an antenna two miles long and of rather indefinite height as far as radiation efficiency is concerned.

Following our lead in educational radio, a broadcast station in Berlin has started to radiate some university courses two evenings a week. While intended primarily as a help to those who attend the university, probably some data will be obtained as to the general appreciation of this type of broadcasting.

Is Education by Radio Wanted?

IN AMERICA, it seems likely that the demand for solid educational material is one which has to be cultivated. By far the vast majority of radio listeners regard the radio

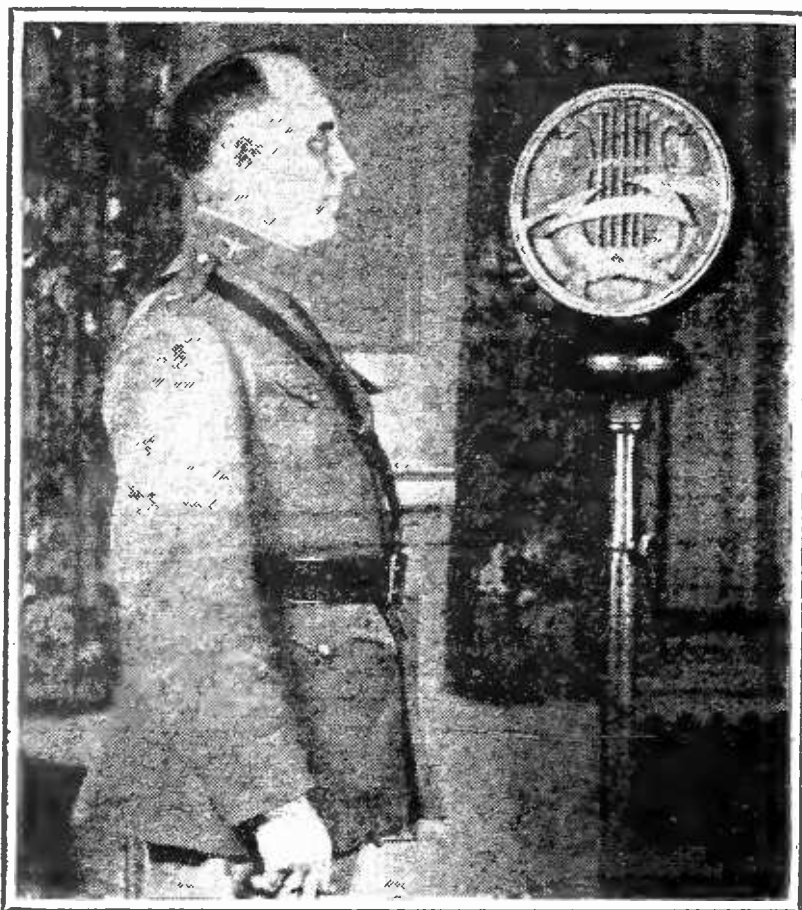

MAJOR WILLIAM N. HENSLEY, JR.
Commanding Officer, Mitchel Field,
New York

"The adaptation of radio to the airplane has completely changed the aspect of war. Under present conditions, an enemy would have no secrets. To mass troops at any one point would simply serve to inform the opposing forces that an offensive was contemplated. Artillery fire could be directed with such deadly accuracy as to annihilate any stronghold. The gun pointer would have first hand and almost instantaneous information as to the necessary corrections with the result that big guns can be fired with the precision of a rifle"

channel as one through which material for entertainment rather than education should be sent. It is not at all impossible that the educational possibilities of radio have been overestimated. Possibly the contact with the instructor, the opportunity to ask questions, to get his criticism and occasional praise, have a much higher value in the field of education than is generally supposed. The progress of educational radio must depend upon its reception by the public, and the public's demand for it may show conclusively, as has often been stated, that the teacher, and not the method or material taught, is the factor which advances the world's knowledge.

Yap Gets a Radio Station

THE small island of Yap in the western Pacific has several times loomed up in international affairs with a valuation much greater than its physical dimensions and natural riches warrant. It occupies a strate-

gic position in cable and radio communication between the eastern and western shores of the Pacific and assumes unexpected importance, especially for Japan and the United States.

At the Disarmament Conference in Washington, Japan was granted mandatory powers in Yap, with the provision that other interested nations should have equal rights with Japan in the use of its communication facilities. Japan now announces her intention to erect next year a powerful radio station in Yap, presumably to increase the certainty of her transpacific communication channels. Undoubtedly the new station will be used for relaying. In that rôle it would be useful also to the United States when static interferes with the long spans over which our present circuit to Japan extends.

Coöperation in Solving Interference

IN A recent issue we had occasion to commend the activities of Mr. Alfred Caddell of the American Radio Association and used as an illustration of the work he was attacking with success the question of interference in the broadcast channels caused by the steamers of the New England Steamship Company, which carried on a heavy commercial traffic with spark transmitters.

The interference was there without any doubt, and we quite naturally commended Mr. Caddell for the lively measures he was taking to eliminate it. We have received a very courteous letter from the president of the Steamship Company asking us to assure the broadcast listeners that his company was anxious to help in clearing up interference as much as possible. In accordance with the recommendations made at the last radio conference the ship traffic is now being carried on on a wavelength much farther removed from the broadcast channels than the originally interfering wave of 600 meters, and he hopes the interference nuisance has been done away with.

His letter, however, contains one naïve statement which we think worth while passing along. "I get no interference from these steamers," says Mr. Parnell, "although I use a simple set consisting of three stages of radio frequency, a detector, and three of audio frequency, seven tubes in all." Well, naturally, he gets no interference. Three stages of tuned radio frequency will eliminate a whole lot of interference, but surely this is a rather expensive equipment to expect the average broadcast listener within a few miles of New York to use. If all the listeners who have

been bothered by the ship traffic would put in three stages of tuned radio frequency, the interference problem would unquestionably be solved, but the expense involved for the listeners might in the aggregate be sufficient to buy out the Steamship Company. An easier and more equitable solution, which we feel sure will more likely meet with commendation from the broadcast listeners, is for Mr. Parnell to order his ships to use their spark sets no more than absolutely necessary during broadcasting hours, and we are sure from the tone of his letter that suggestions of this kind will be complied with as much as possible.

Interesting Things Interestingly Said

MAJOR GENERAL GEORGE O. SQUIER (United States Army, retired; former Chief Signal Officer): "A world-wide net of electrical intercommunication linking together radio, land lines, and submarine cables in a new-born spirit of closest coöperation must be developed to the limit of possible usefulness, both for the needs of peace and as a powerful agency in preventing war."

GEORGE J. ELTZ, JR. (New York; Treasurer, Radio Apparatus Section, Associated Manufacturers of Electrical Supplies): "A large number of people who have been indifferent to the appeal of radio have just awakened with a start to find that the art has been making great forward strides. Moreover, radio has taken on a new artistic nature. When broadcasting first began, there was the attractive novelty of drawing music and speech from the air, and just what came mattered little, but now the main interest is in the quality of the entertainment and the perfection of its reproduction. A critical interest is being taken in programs, which is brought forcibly to the attention of broadcasters by the thousands of letters they receive each day."

HARRY L. FOSTER (travel writer, in *A Gringo in Mañana Land*) tells of hearing a radio concert in the Honduran wilderness at the house of a mine superintendent at Rosarie): It was as clear as though one listened-in from New York. Out there in the wilderness, forty miles from the nearest town, and many hundred miles from a railway, gringo energy had produced all the comforts of home.

"That's Vincent Lopez in the Pennsylvania Grill," the superintendent informed me. "Wait until I get Schenectady, and we'll have a bedtime story."

WILLIAM M. BUTLER (United States Senator from Massachusetts): "Citizens who heretofore regarded politics as an incident in the life of the nation have now, thanks to radio, a keener



HERBERT H. FROST

Chicago; President, Radio Manufacturers' Association

"By next summer, the new high power broadcast stations, authorized at the recent Washington radio conference will be in operation and they will make it possible for the farmer to receive his market and weather reports during daylight hours. Heretofore, such reception has been difficult, which kept the farmer from buying radio. Now, probably not more than fifteen per cent. of the American and Canadian farmers have receiving sets.

"The best engineers in the country are of the opinion that there will be no fundamental changes in radio receiving equipment in the next few years. Development in this respect is bound to be gradual and there is no danger that a person will secure a good set to-day and to-morrow find it obsolete.

"Radio has ceased to be a fad. It is the greatest source of communication since the first language was developed."

insight and a fuller appreciation of political activities. I have been much impressed with the political importance of radio as illustrated during the progress of the national conventions. I think that those of us who listened-in must have had sober moments when from the convention hall, the actual voices of the delegates came to our ears as well as the disturbances and interruptions."

H. P. DAVIS (Pittsburgh, vice-president, Westinghouse Electric and Manufacturing Company): "International broadcasting, as I have consistently stated in the past year, must take its place as a regular feature of broadcast programs, and this may come in the very near future."

CHILDREN Sing for wBz," says a headline in a Boston paper. Which goes Castoria one better.—*Boston Transcript*.

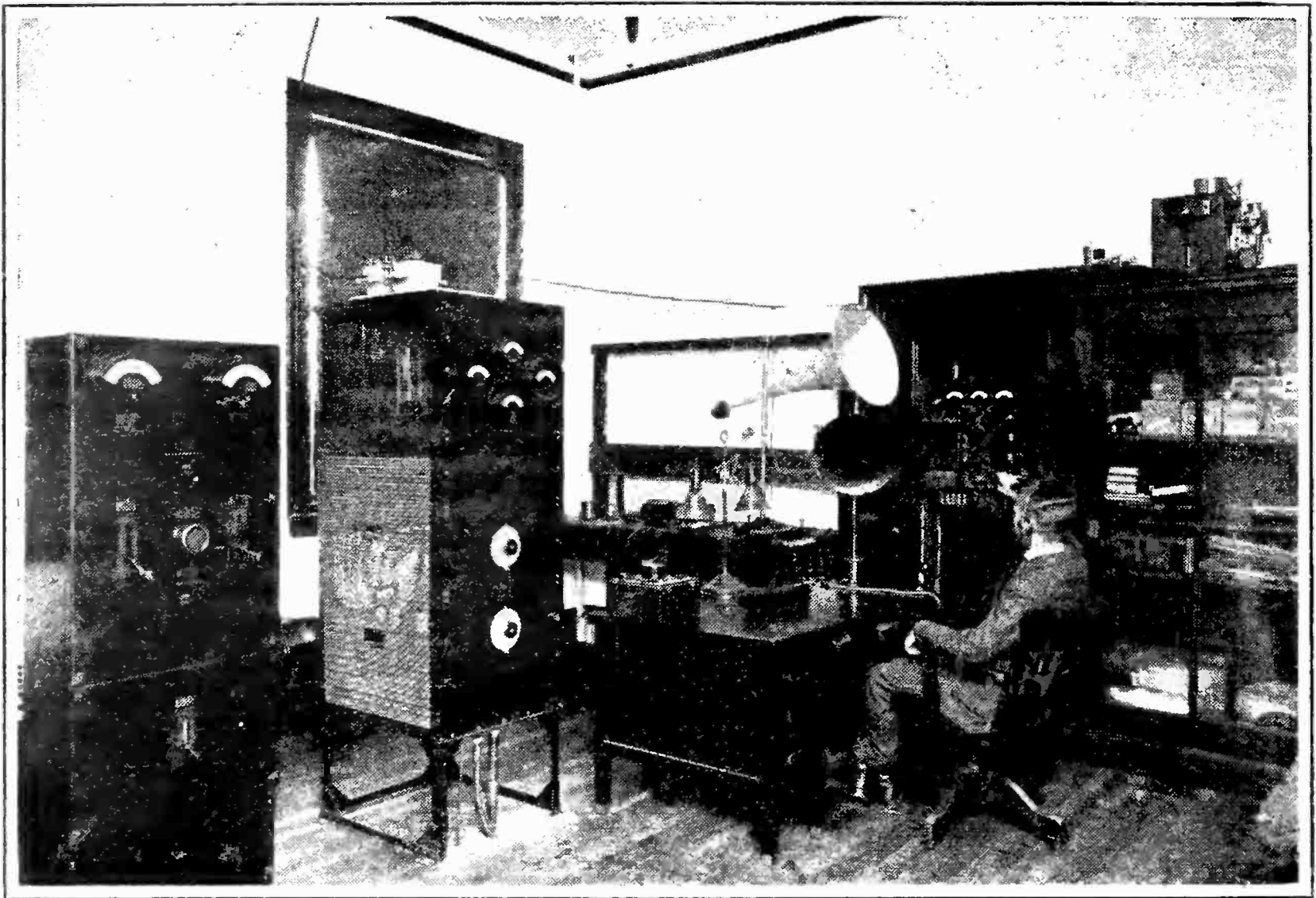

STATION WHAZ

At Rensselaer Polytechnic Institute, Troy, New York was one of the first college broadcasting stations to be installed. It is pointed out that a college broadcasting station is quite as good an advertising medium for such an institution as it is for a radio manufacturing concern

Who Owns Our Broadcasting Stations?

BY DUDLEY SIDDALL

MR. B. C. PHANN, his wife and kids, aren't using their radio set as they used to. Six months ago it was a novelty. At first the whole Phann family came a-running at the mere cry of "Here's some DX!" But after a few weeks the thrill wore off. To-day the Phanns wouldn't sit up till midnight to hear Havana.

The Phann family has become discriminating. Nothing less than a surpassingly good radio feature will keep them away from movies, theatres, magazines, books, and other diversions. Radio no longer intrigues them with its mechanical mysteries. The loud speaker is now forced to compete for their time and attention on an equal basis with

other forms of entertainment, amusement, news and education.

The movies, starting with men whose imaginations ran no farther than a single reel "chase" picture, soon produced directors like D. W. Griffith. The theatre has its creative geniuses like David Belasco. Magazines are edited by men who appear very definitely to know what the public wants, such as George Horace Lorimer and Ray Long. Books, when written by Gene Stratton Porter or Edna Ferber sell by the hundreds of thousands. In every line except radio, huge incomes await men and women who can capture public interest.

Analysis of information showing the owner-

ship of broadcasting stations proves beyond question, if there were any question, that the vast majority of broadcasting stations are operated largely for advertising purposes: in other words, as a feeder for the broadcaster's real business interest, his radio store, his garage, his jewelry shop, his clothing store, or his dance hall. So there are many who claim that the radio broadcasting station has much in common with the old time, now almost historical patent medicine vendor's show. It is, basically, they say a bally-hoo. Obviously no bally-hoo can hope to approach the proportions of grand opera, a feature film, or a Broadway theatrical production.

CASES IN POINT— WITHOUT NAMES

CONSIDER a specific station, in a Southern state. In 1922 an electrical store put in a line of radio supplies. To draw trade, the dealer installed a 500 watt transmitter and hired a local newspaper reporter on a part time salary of \$20 a week as "director." This reporter is also the announcer, the publicity man, the scout for talent, and all the rest of the non-technical staff. One of the store clerks serves as the engineering department of the station. The "director" has long since made the rounds of such local talent as can be induced to sing, play, or talk. He has no fund to hire artists or even to buy them dinners and taxi rides. All things considered, he does fairly well; but he has no opportunity to give his radio audience anything better or bigger or newer or more impressive than as if he were directing a Sunday school social entertainment.

The dealer who pays the small weekly bills for this station charges the expense to advertising and is content. At heart he is an electrical retailer. Even if he were willing to spend \$2000 a night on talent, which he isn't and never will be, he wouldn't know how to do it.

Another case. A chief executive in a metro-

politan city plays with radio as a hobby. His real job is selling building materials. He cheerfully writes out a small weekly check to support a broadcasting station just for the fun of the thing.

Much the same sort of a motive is back of a station operated by a large service company. A high executive in the organization is a radio enthusiast. He is so high up that nobody questions his right to use company time, men, and money to build a transmitting station; nor to pay a part-time salary to a publicity expert to "direct" it. Ostensibly the station is run so "that employees may be benefited."

Thus the bills pass the auditing department under the general heading of welfare work. But those on the inside like to call this station "the chief's toy."

Newspapers, not knowing exactly what effect radio was going to have on their business, went into broadcasting on a fairly large scale to find out. Many of them did find out, and soon there was a lot of transmitting apparatus in newspaper storage rooms for sale cheap. A few papers, strategically located, have been able to make broadcasting pay by adding

special radio sections to their Saturday or Sunday issues. Because the papers with broadcasting stations stand out as "radio mediums" they garner most of the radio advertising in their territories. These exceptions will stick to broadcasting as long as radio advertising volume holds up. Since the expense is usually charged to "promotion" it is certain that no radical artistic program innovations of an expensive nature will ever come from this source.

Nor can the public expect anything very highly artistic or highly important from the municipal stations, of which WNYC, New York City, is a notable example. Whether or not a municipal station is, as has been charged, a bally-hoo for the politicians is of no importance. The fact remains that tax-payers

What the Idea Is

Many radio listeners have often asked themselves, or what is more to the point, others, who owns all the vast numbers of American broadcasting stations. Those who tune-in, night after night, to the more or less varied programs from every section of the nation, should be, and usually are, interested in knowing the ownership of the stations figuratively knocking at their antenna insulators each evening. Mr. Siddall has analyzed the ownership of our 550 stations and has included some interesting remarks of his own about the general problem of who is broadcasting, how they are doing the job, and what is likely to happen to broadcasting. According to the estimate of the writer, it takes roughly 11,000 separate features to supply American broadcasting programs for one day. Is there that much talent in the country to supply material for each of the 365 days?—THE EDITOR.



MANY PURELY COMMERCIAL CONCERNS

Have gone into broadcasting, presumably directly to influence their sales. This photograph shows the bank of batteries used to run the station which is maintained by a battery manufacturer

would resent any lavish expenditure for talent on the part of a municipal broadcasting station. City officials are not elected for the purpose of giving nightly musical entertainments. So, while municipal stations may perform certain modest functions very capably, the people who sign "Irate Tax-payer" to their letters "to the editor" can be depended upon to sit on the municipal lid.

HOW GOOD A JOB IS BEING DONE

EDUCATIONAL institutions, churches, national guard, chambers of commerce, hotels, department stores, grain and feed establishments, monument dealers, lawyers, a chiropractic school, newspapers, music-stores—so runs the list of broadcasters. Plainly, they are using radio to advertise everything from the Gospel to "\$2 Dinners With Dancing."

Day after day and night after night these stations pour forth programs. Take a pencil and figure out the staggering quantity of stuff that is annually being pushed into the air. Suppose each of the 550 broadcasting stations operates two hours a day, and suppose that the average length of each program number is six minutes, or ten items an hour. Multiply 550 by 2 by 10. The answer is 11,000; for

this is the daily number of program items required to fill in the time of America's broadcasting stations. Now multiply 11,000 by 365, to get the annual number of items. The answer is 4,015,000. If you're conservative, cut this in two and you'll find that at least 2,000,000 songs, dance numbers, sermons, Republican, and Independent conventions, talks on the rubber heel industry, and bedtime stories have to be gathered and disseminated annually by the broadcasters. The wonder is, not that they do such a bad job, but that they do such a good one.

Broadcasting is still very young. It began in September of 1921. In January, 1922, the licensed broadcasting stations numbered only 28 for the whole United States. By fall, or

October 1 to be exact, the number had jumped to 539. At that point the swiftly rising curve flattened out and ever since then the number of licensed broadcasters has hung around the 550 mark. On July 1, 1924, there were 549 stations; only ten more than on October 1, 1922.

The mortality is heavy; as many as 80 stations having been deleted from the list in a single month. Twenty deletions is about the average. Always, however, other new and hopeful advertisers have come along to throw their waves out into the great unknown, so that the total number of stations steadily stays between 500 and 600.

Of the 549 stations which were licensed up to July 1st, last year, 224 were pretty definitely advertising radio. That is, these 224 stations included radio manufacturers, radio jobbers, radio stores, garages handling radio equipment as a sideline, department stores featuring radio sections (of which there were 20), and music stores which were taking no chances on having their phonograph and piano business literally vanish into the air. To this classification could be added 11 stations operated by such concerns as the American Telephone & Telegraph Co., the General Electric Co., the Radio Corporation of America, and public

utilities which are in radio either for sales or experimental and patent motives. In other words, 235 or about 43 per cent. of the broadcasting is now being done by firms who have a direct interest in the radio industry.

EDUCATIONAL INSTITUTIONS NEXT TO RADIO

NEXT to the radio industry come the educational institutions with 92 stations. They are delving in broadcasting slightly, very slightly, from scientific motives; but largely, very largely, one may confidently assume, from the same advertising motives that impel them to build up strong football teams. Since October 1, 1922, the number of "educational" broadcasting stations has increased by 50 per cent.

Newspapers come third with 42 stations, just a little more than half the number operated by newspapers two years previously, before the worried business managers found they had little to fear from radio.

Fourth on the list are religious organizations with 31 stations; three times as many as on October 1, 1922. Presumably there would be many more of these "air churches" if more religious organizations had the money to build and operate them.

Miscellaneous business establishments, ranging from a song book printer to a dance hall, account for 23 more. Municipal, national guard, chamber of commerce, and other community stations number 21, while clubs of various kinds operate 10 stations. Broadcasting is being indulged in by 7 theatres and 5 hotels. Added to all these is a group of 83 stations, chiefly of low power, in the hands of private owners and small business houses.

WHERE WE ARE NOW

IT IS not the purpose of this article to present any of the numerous schemes for bettering broadcasting, but simply to show the sources

from which America's programs are now coming. And yet, on behalf of Mr. and Mrs. B. C. Phann and the Phann children, this word might be added:

This year Mr. and Mrs. Phann are spending \$350,000,000 on the mechanics of radio: that is, for parts, sets, batteries, tubes, and the rest of the paraphernalia. They are spending, practically, one million dollars a day not to count the hours and hours of time.

For this time and this money they are getting nothing, fundamentally but advertising in one form or another. They are getting the bally-hoos of political leaders, of ball clubs, of fighters, and football teams. They are getting the bally-hoos of hotels which have dance orchestras. They are getting the bally-hoos



THE ST. LOUIS "POST DISPATCH"

Has successfully operated station KSD for some time. This newspaper is one of a number of great newspapers in the country which has entered whole-heartedly into the "business" of broadcasting



© Western Electric Company

STATION WCBD

Zion City, Illinois, is owned and operated by the religious community there under the direction of Wilbur Glenn Voliva. Entertainment and religious programs are regularly broadcast from this station

of actors (for the most part out of jobs) who want to "keep their names before the public." They are getting the bally-hoos of churches, of health departments, of colleges, and of popular music publishers.

The fact that a portion of these bally-hoos are good is utterly beside the point. The issue is that broadcasting of to-day is all bally-hoo—the advertising of something. The radio fans who are spending a million dollars a day are entitled to more than that. Radio, to grow into an art as the movies have grown into an art and to compete with the movies,

theatres, and other arts, must find new and better food for its head phones and loud speakers. It must find inducements for directors of genius and artists of ability: men and women who can express themselves to the multitudes through the sense of hearing just as the creators of the movie art have, in twenty years, learned to translate artistic expression into terms of sight.

When that day comes, the public which is spending a million dollars a day on radio mechanics will gladly spend twice or three times as much on radio art.

THE material appearing in this magazine is fully protected by copy right, and editors of periodicals are advised that unauthorized publication of circuit diagrams, technical descriptions, and parts or the whole of articles, without due permission and credit, is an infraction of the law. Those who wish to reprint material appearing in these pages are asked to communicate with the editor.

“NOW, I HAVE FOUND. . .”

A Department Where Readers Can Exchange Ideas and Suggestions of Value to the Radio Constructor and Operator

FOR a long time, RADIO BROADCAST has felt the need of an outlet for the many excellent ideas dealing with various features of radio construction which reach our office. With this issue, we begin the department of good ideas from our readers, and invite the coöperation of all those who are interested.

If you have an idea about a valuable and useful new circuit, some new device, a construction or operating suggestion, we should like to have it. Payment of from two to ten dollars will be made for every idea accepted. The descriptions should be limited to three hundred words and typewritten. Accompanying sketches, drawings, and circuit diagrams should be as plain as possible.

We do not want simple, obvious suggestions. Material to be acceptable for this department must offer something of definite value to the constructor. Mere novelty is not desired. Address your manuscripts to this department, RADIO BROADCAST, Garden City, New York.—THE EDITOR.

A FORM FOR ROBERTS COILS

THE easiest way is to make a tin template to start with, from which any number of forms may be made, which will be handy when your friends hear your Roberts set and want to make one like it,

Cut a circular piece of tin $4\frac{1}{2}$ " in diameter;

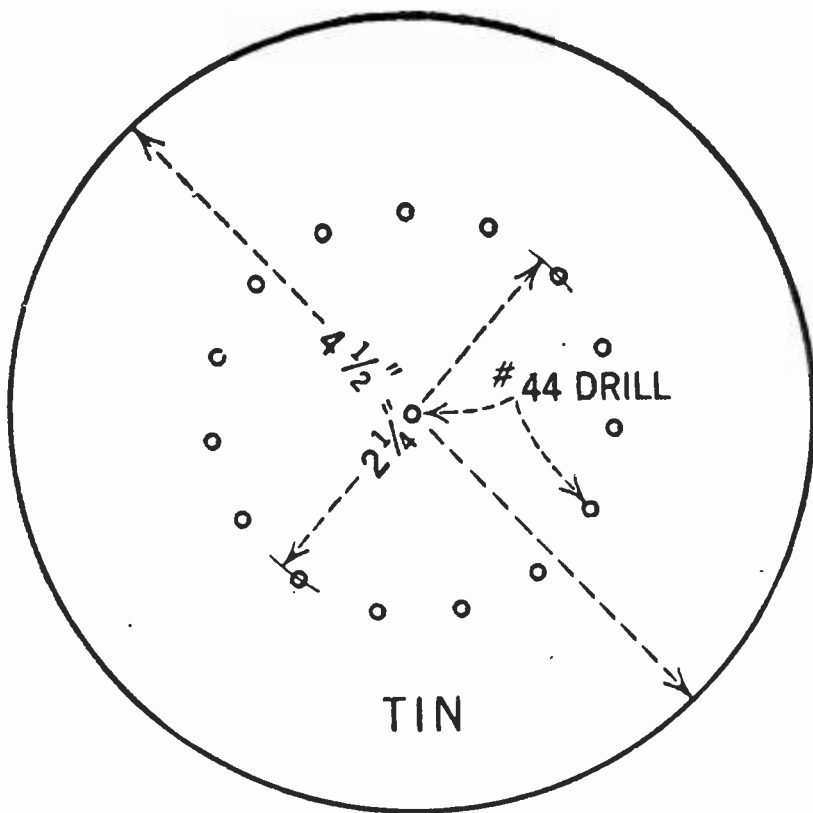

FIG. 1

then strike a circle on this piece $2\frac{1}{4}$ " in diameter. Set the dividers a little less than $\frac{1}{2}$ " and starting at a mark on the $2\frac{1}{4}$ " circle, "step" the dividers around the circle counting the steps, the object being to make 15 divisions on the circle. This will take several trials and some patience. When at last you have the dividers set right, mark the 15 divisions and center-punch them. Drill them out with a small

drill, No. 44 or smaller. Drill the center hole with a No. 19 drill. See Fig. 1.

Cut out 5 pieces of $\frac{1}{16}$ " either red or black fibre $4\frac{1}{2}$ " in diameter and drill the center hole with a No. 19 drill. Bolt the template to one of the fibre pieces with an $\frac{8}{32}$ screw and run the small drill through the fibre using the holes in the template to guide the drill. Take off the

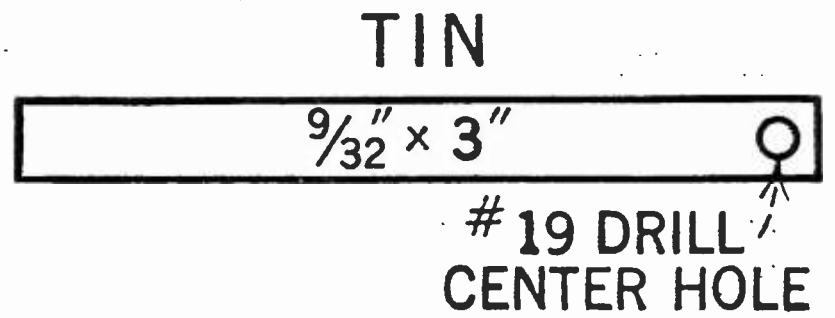

FIG. 2

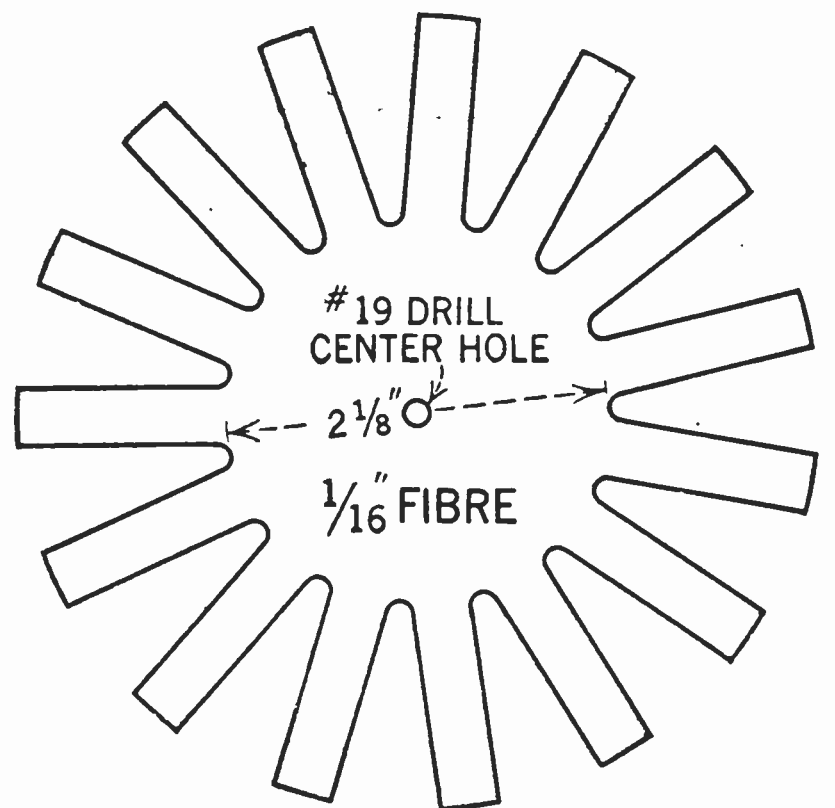

FIG. 3

template and ream out the holes in the fibre with the No. 19 drill.

Cut a strip of tin as shown in the sketch Fig. 2 and bolt it to the center of one of the fibre circles. Mark the spokes with it using a scratch awl and not a pencil, then cut on these lines with the tin snips and you will have a perfectly good form. See Fig. 3.

The forms should be boiled in paraffin for about ten minutes before winding or they will absorb moisture. After they are wound, the coils may be painted with a thin solution of celluloid dissolved in acetone.—HARDING Gow, East Sound, Wash.

A FILTER FOR THE SUPER-HETERODYNE

IN PUTTING up a super-heterodyne along the lines of Mr. McMurdo Silver's set, using Acme 30 kc transformers, I found that the filter suggested, though not recommended, caused considerable distortion (due possibly to the cutting off of some of the

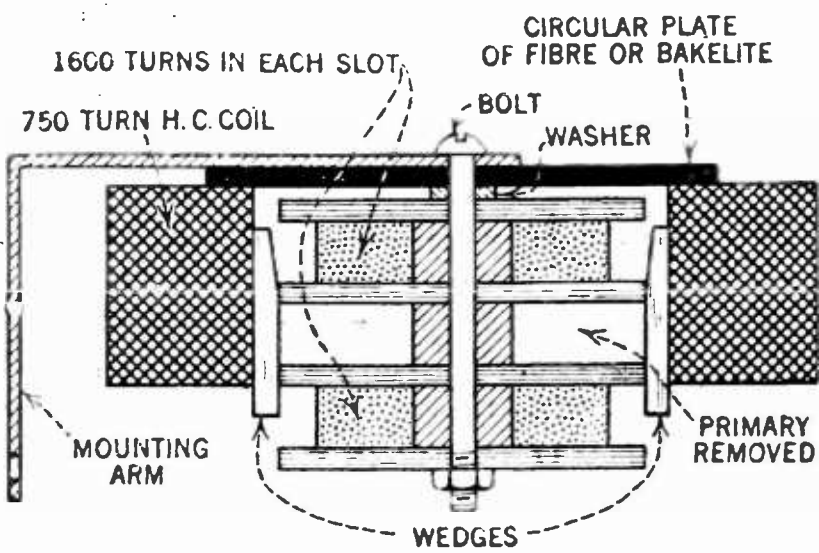

FIG. 4

side bands). I then worked out a filter which not only produced no distortion, but which also brought about sharper tuning and more volume.

I removed the primary of 800 turns and placed the form bearing the two secondary coils, as described in Silver's filter, inside a 750 turn honeycomb coil providing the necessary mechanical support as shown in the sketch Fig. 4.

Connect the small coil as an untuned primary and shunt the honeycomb coil with a .001 mfd. variable condenser or approximately .0005 mfd. fixed condenser making this the secondary of the filter. With this substitution and using the Acmes in the two intermediate R. F. steps I could not ask for a smoother operating set than McMurdo Silver's set as described in

October RADIO BROADCAST.—F. S. WHITE, Syracuse, N. Y.

A PICKLE-BOTTLE COIL FORM

HERE is a stunt that you might pass on to your readers so that pickle-bottles will be not in such great demand for coil-winding purposes.

In a circle, inscribe an octagon of the size required for the coil to be wound, as in Fig. 5.

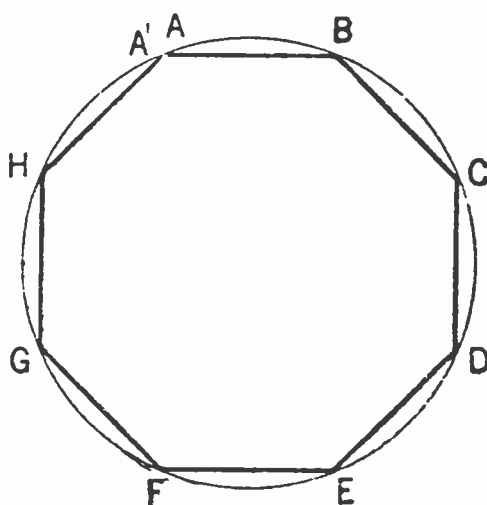

'INSCRIBE AN OCTAGON WITHIN A CIRCLE'

FIG. 5

Next, cut a strip of tin A-A' long and about 2 1/2" wide. See Fig. 6. Allow 1/4" at each end for a joint. Bend and form the joint first, then fold at B-C-D etc., to obtain the shape as shown in Fig. 8.

Bend a piece of tin for a clamp, or slot a thin-walled brass tube so it will slip over the flaps as shown in Fig. 7.

Small angles of tin may be soldered at one

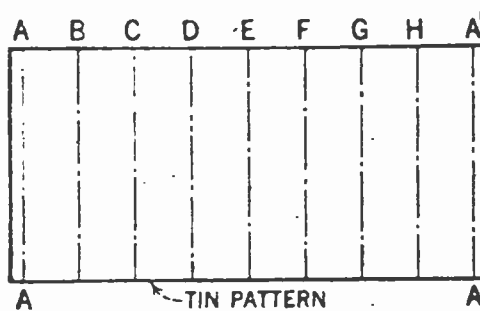

FIG. 6

end of the completed form to guide the wire in a smooth, straight manner. Wind the turns closely together and when the proper width of coil has been wound give it a light coating of "dope" consisting of celluloid dissolved in acetone. The demountable form may be removed by withdrawing the slotted tube first.—R. B. CLAPP, Cleveland, Ohio.

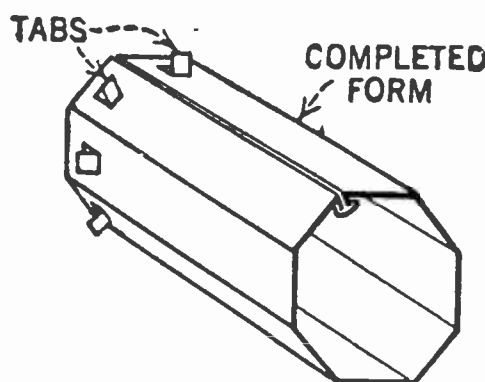

FIG. 7

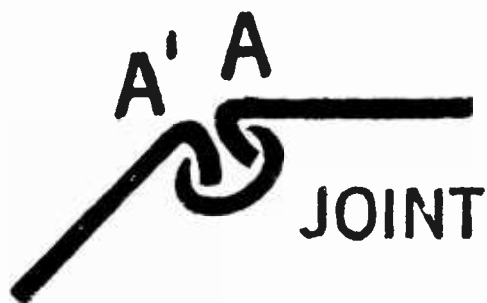

FIG. 8

ANOTHER WAY OF WINDING THE COILS FOR THE K. O. CRYSTAL REFLEX RECEIVER

IN WINDING the T1 and T2 coils used in the RADIO BROADCAST Knockout crystal reflex receiver, I am pleased to submit an idea of my own for getting clear of the trouble of supporting the leads for the primary, or smaller winding.

First, wind the primary on a tube of the proper size for the entire unit and bring out the leads as shown at A, Fig. 9. This keeps the primary winding tight. Next, place empire cloth or any other form of insulation, on each side of the primary to build up an even layer as at B. Then put on a wider piece of cloth the full width of the secondary coil as at C. Next, wind the secondary and bring out the leads as for the primary as shown at D. The result is a smooth layer of wire with no leads shown. The main point is that all the coils are tight. This system is better than when the primary coil is wound on top of the secondary.—W. A. WEST, Hopewell, N. S.

USING STANDARD COILS IN THE ROBERTS CIRCUIT

HERE is a suggestion that might be of interest to your readers. Most of the ready-made coils for the Roberts circuit are rather costly and in some instances

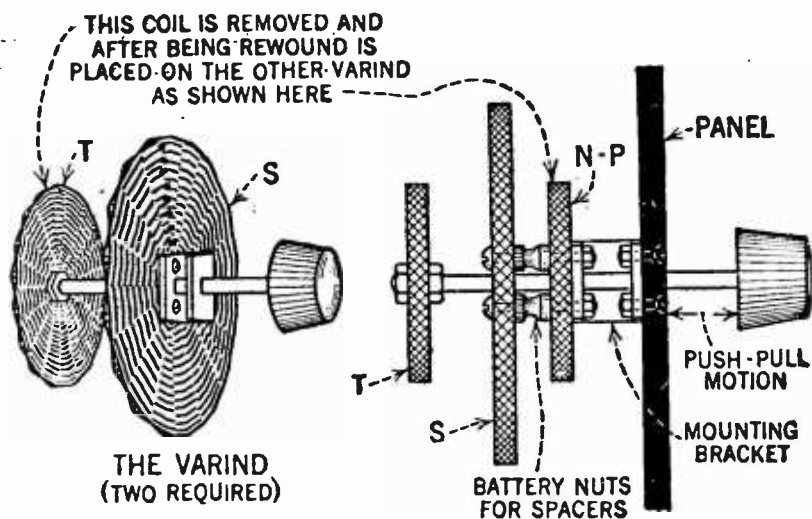

FIGS. 11 AND 12

appear to be somewhat weak mechanically as regards the adjustment of the tickler.

I have used two Crosley Varinds such as is shown in Fig. 10 and while I have not a per-

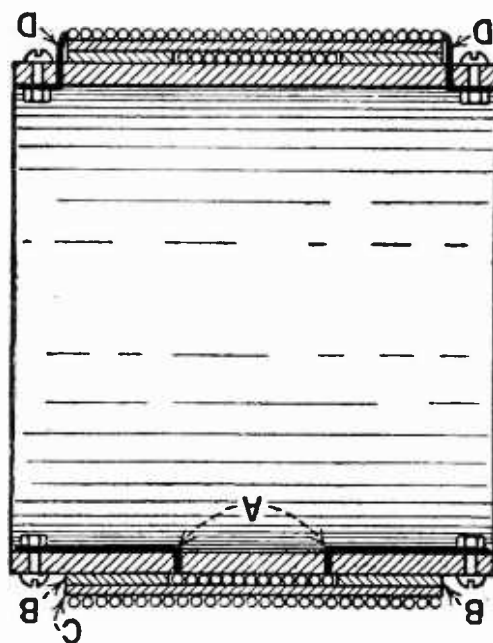

FIG. 9

manent installation, they give promising results. The tapped coil on one of the Varinds may be used as a single circuit for the primary or may be used as the primary and secondary of the antenna coupler by dividing it into two sections as shown in Fig. 11.

On the second Varind, the tapped coil was replaced with a winding of larger-sized wire for the secondary, the sliding coil used as the tickler, and the coil intended for the tickler on the first unit, constituting the N-P form. See Fig. 12. This latter coil must be re-wound with a pair of wires to provide the N-P winding.

A pleasing panel appearance is produced and the units are mechanically substantial.—C. C. SHUDER, Sumner, Ill.

THE REMAINING SECONDARY IS CONNECTED AS FOLLOWS

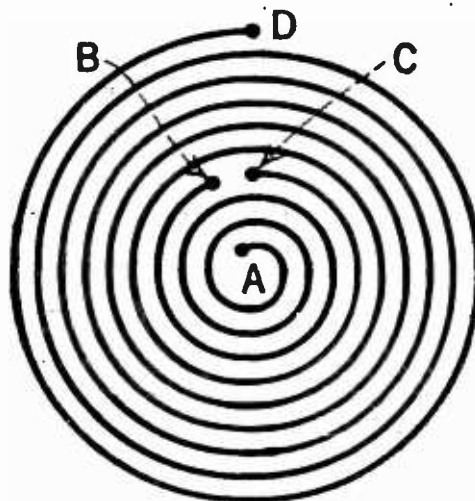

A B = PRIMARY
C D = SECONDARY

FIG. 10

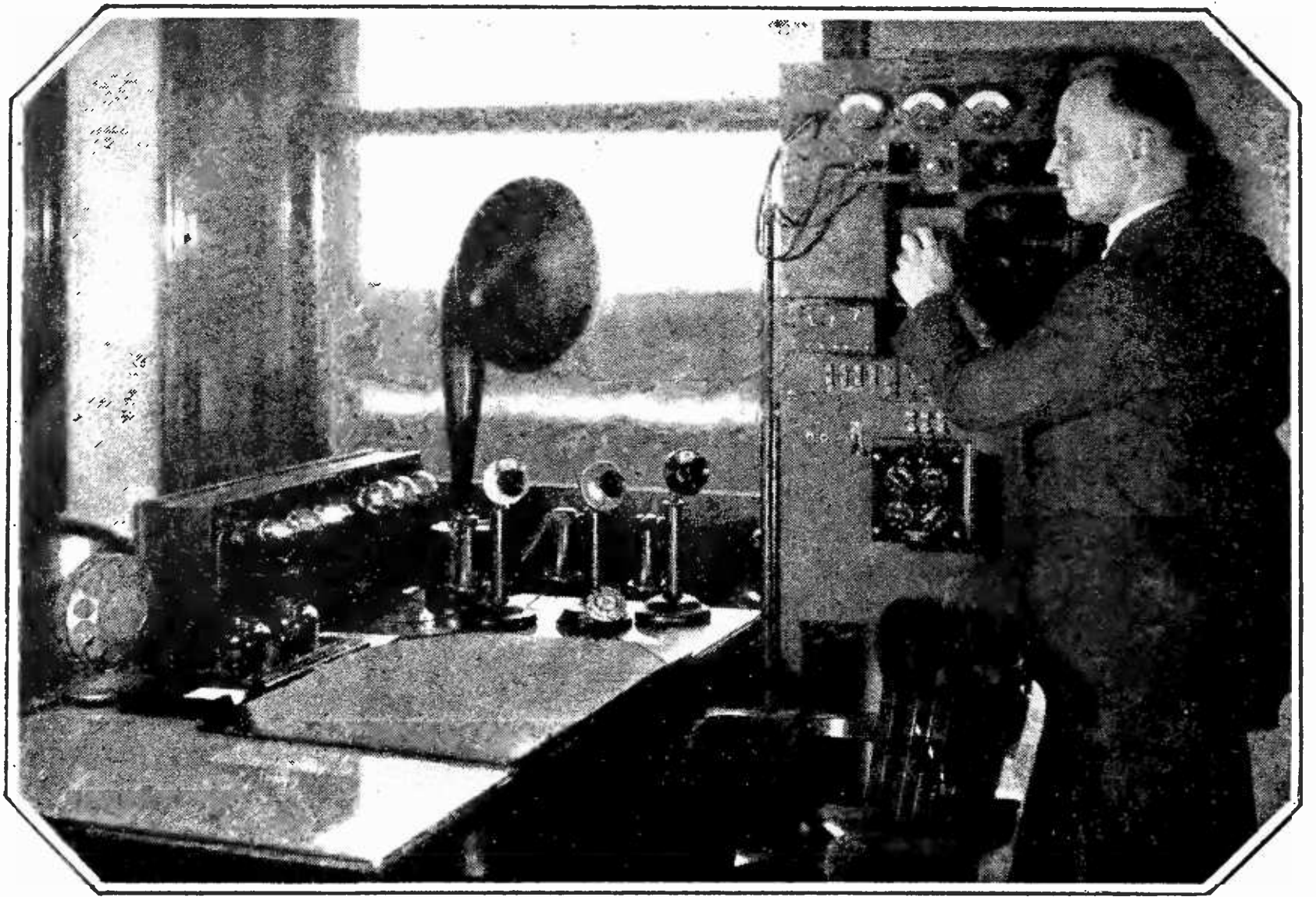

THE CONTROL ROOM AT STATION WJAX, WHERE SOME OF THE RADIO DRAMA OCCURRED

Our Busiest Day

When Two Political Conventions Were Going on at the Same Time—Some Interesting Sidelights on the Life of a Broadcasting Station Engineer—What Goes on Before the Curtain is Raised

BY DON S. KNOWLTON

Manager, station WJAX, Cleveland, Ohio

JULY 4, 1924, was the busiest day we ever had at station WJAX.

The excitement really started several days before, when we hooked in on the American Telephone and Telegraph Company wire tie-up and began broadcasting the National Democratic Convention from Madison Square Garden in New York. After that had been going day and night for a week the boys in the station began to get slightly weary and every time the words "twenty-four for Underwood" came through, the gang set up a cheer you could hear from one end of the twenty story Union Trust Building to the other.

To top that, along came the Filipino Orchestra from the S.S. *Leviathan* on a radio broadcasting tour. They were due to broadcast over our station on the evening of July 3rd.

We had the machinery all set up so that this *Leviathan* orchestra could do their act down in the lobby of the Hotel Cleveland and we had our remote control panel and our line installed to do the broadcasting from that location in the evening.

And then the Democrats kept right on gumming things up. Of course, we had expected that the Democrats would get through nominating and go home by that time, but they didn't. They kept right on going during the day hours of July 3rd and started in on a long evening session. Would the Democrats get through in time for us to broadcast the *Leviathan* orchestra, or wouldn't they? The *Leviathan* crowd had to make a train at twelve o'clock that night.

While we were stewing about that, in came the word that we were to broadcast the La

Follette Convention from the Public Auditorium in Cleveland the next day, July 4th!

That certainly did set the electrical kettle boiling.

Here we were all tied up with a Convention coming in from New York, sitting around waiting to work in the remote control job from the Hotel Cleveland, and along came the news that we would have to get our hook-up all set down at the big Public Auditorium in Cleveland for still another job, beginning at ten o'clock the next morning!

Well, Thorburn, our engineer, and Johnson, our announcer, work on the theory that nothing is impossible. If it had to be done, it had to be done, that was all.

THE DEMOCRATS CONTINUED BALLOTING

THE Democrats kept right on balloting. They balloted so long that the *Leviathan* orchestra didn't get a chance to broadcast at all. So at eleven o'clock that night, Johnson rushed our remote control panel from the Hotel Cleveland down to the Public Auditorium and began to get all set for our installation down there. He worked until about two in the morning and then the boys decided that sleep was more important at that time than any microphone or control panel in the world.

At six o'clock the next morning they were back again at the Public Auditorium and completed their installation. This consisted of a tie-up with the public address amplifying system already installed in the auditorium.

While the boys were working on that, we had to set up our glass broadcasting booth on the stage of the Public Auditorium just behind one of the wings, as near as possible to the speaker's platform. At four o'clock of the afternoon of July 3rd, this broadcasting booth lay knocked-down in several pieces up in the storeroom of the twentieth floor of The Union Trust Building. Between four o'clock that afternoon and eight o'clock the following morning, movers took the sections of this booth down to the Public Hall, a building company put the thing together and set it up, and then our remote control panel had to be installed inside of the broadcasting booth and the lines tested.

THE LITTLE OLD LADY IN BLACK

THE Convention was due to open at ten o'clock. At a quarter of ten the boys were almost desperate. It didn't seem possible to get the job done in time. Three minutes of ten—two minutes of ten—at last the

installation was complete and they made the test.

The test was rotten!

Something was wrong. The tie-in with the general amplifying system didn't work worth a hoot.

The Chairman mounted the platform with his gavel in his hand.

"Oh! what's the use," Johnson cried, and slammed a pair of pliers on the floor.

But just then we had a life saver.

A little old lady in a black dress and a black hat—I don't know who she is, but she certainly saved our lives—came bustling up on the platform and she said to the Chairman:

"But we haven't rehearsed our songs yet. We must rehearse our songs."

"But," the Chairman objected, "we have got to start this Convention, it's due to start at ten o'clock."

"Well, the Convention will just have to wait until we rehearse our songs!"

The Chairman gave up, and the old lady gathered about her a group of women who began to rehearse the various La Follette songs which the convention was going to sing.

Suddenly Johnson had an inspiration.

"Well! we can try it," he said, "we will see if we can't put in our own installation."

If you think you know what fast work is, you ought to have seen the boys fly around during the next few minutes. They tore out entirely the hook-up with the amplifying system, got their own microphone and put in their usual remote control plan of installation, running the cord from the remote control panel through the roof of the broadcasting booth, down to the floor, under the chairs of the delegates who were seated there, and up on to the speaker's platform.

The installation was almost complete—all that was necessary was to place the microphone up on the top of the speaker's platform—and then—a terrible catastrophe.

The cord wasn't long enough! It wouldn't reach! It lacked two feet!

The ladies stopped rehearsing their songs and once more the Chairman mounted that platform with the gavel in his hand.

I wish you could have seen Johnson's face when he saw that that cord wasn't going to reach.

Life just wasn't worth living any more, that's all there was to it.

And then somebody had a bright idea.

"You doggone fool," he yelled, "if you stretch that cord from the top of the booth to the top of the platform instead of running it

down underneath the chairs, it will be plenty long enough!

So while the Chairman of the Convention stood on the platform with his gavel up-raised, ready to call the Convention to order, we were frantically stretching that cord from the booth to the platform, and one of us holding it in place while the other nailed it down.

Bang! went the last nail into place, and at almost the same instant, bang! went the Chairman's gavel and the Convention was on.

At the same instant Johnson was back into his booth,—“This is station WJAX, The Union Trust Company, Cleveland, broadcasting. . .”

The La Follette Convention was in the air!

Well, we went back to the studio and fell flat on the carpet for a few minutes' rest.

TWO CONVENTIONS AT ONCE

THEN the Democrats began to get busy. First came a lot of brass band music and then the invocation and then the reading of the Declaration of Independence address. The thing got under our skins somehow, and as hardened as we were to the radio game we sat up and took notice.

There we were with two loud speakers in the station. Through one was coming the

proceedings of the National Democratic Convention in New York about to nominate a candidate for President. Through the other was coming the proceedings of the La Follette party in Cleveland, preparing to nominate La Follette for the presidency. Our radio audience was getting only the La Follette Convention, but we were getting both at the same time!

Down at the Public Hall in Cleveland a La Follette orator was denouncing what he called the “mad-house” at New York. At the same instant we heard the “mad-house” at New York going full blast.

We left the La Follette Convention in the air until the Democrats had finished their singing and the reading of the Declaration of Independence, and the Chairman's gavel sounded the call of the Convention to order. Then the writer stepped to the microphone and said, “Well, friends of the radio audience, we are now going to switch you over from the La Follette Convention at the Public Auditorium in Cleveland to the National Democratic Convention in Madison Square Garden in New York City.”

Click, went the switch in the operating room and the radio audience jumped from Cleveland to New York, from La Follette to the Democrats, and once more were privileged to hear the repetition of that now world-famous phrase, “Twenty four for Underwood.”

Then late in the afternoon, when the Democrats had finished their daily round and adjourned, once more we switched our listeners from Madison Square Garden back again to the Public Auditorium in Cleveland, where young Bob La Follette was making an impassioned plea on behalf of his father's candidacy.

It was a wonderful, wonderful day, but I can tell you that after it was all over, the most glorious thing of all was to go home and to bed for one good long ten hour stretch.

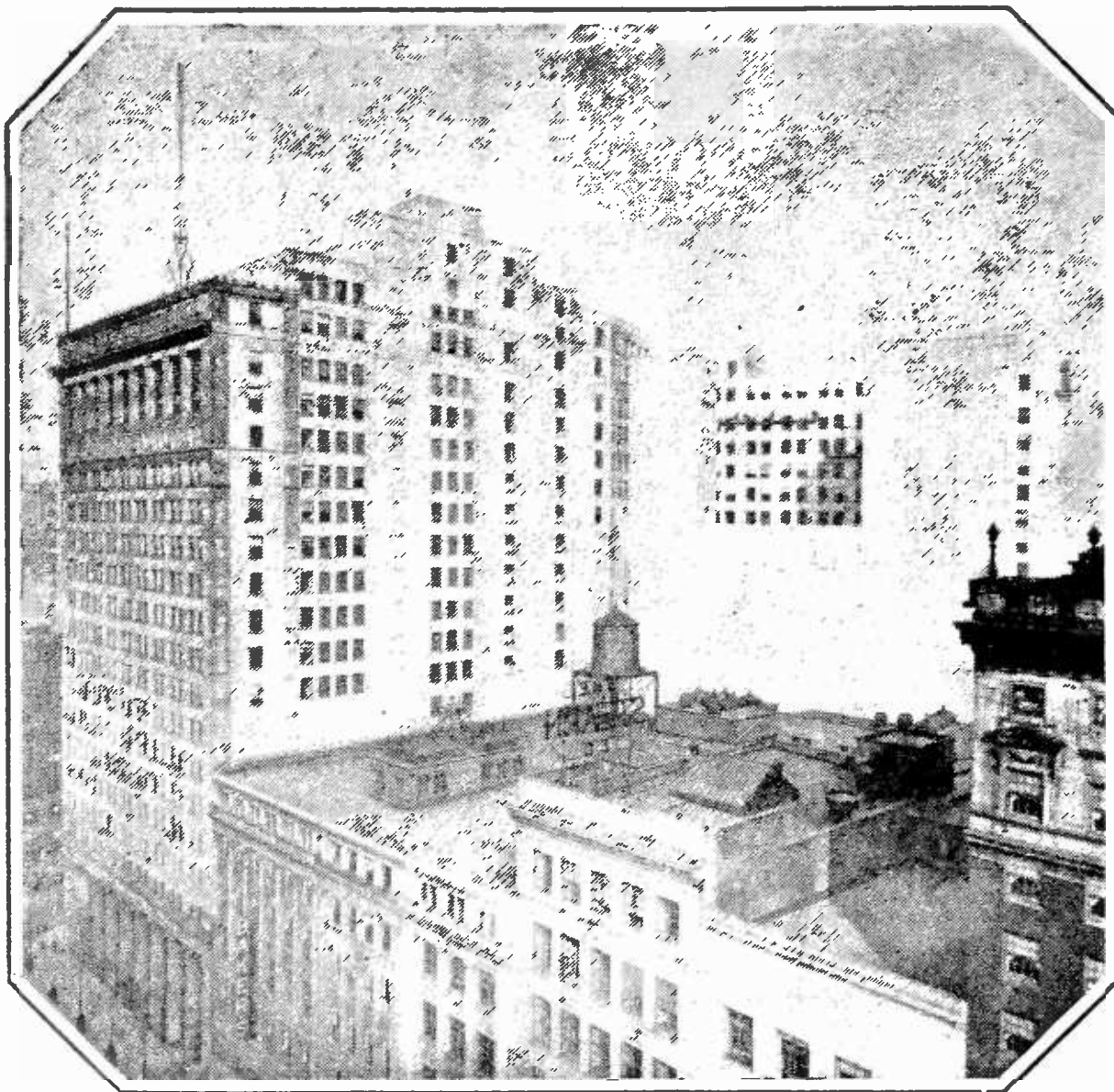

THE TWO ANTENNA TOWERS

Atop the Union Trust Company building in Cleveland, owners of station WJAX



LOSS STABILIZING R. F. CIRCUITS

THE greatest problem encountered in design and construction of radio-frequency amplifiers is the stabilization of the system in which they are incorporated—the dissipating or nullifying of the very strong tendency toward oscillations. This tendency is evident in each r. f. circuit, but is most emphasized *in the second stage of a two-step tuned radio-frequency amplifier*—or in the second and third stages of a three-step intensifier. In general, this tendency may be combatted in two ways—by counteraction, and by losses or absorption. Representative of the first method is the neutrodyne and the reversed feed-back systems, though in a narrow sense, these systems may also be considered as functioning through the introduction of losses. The neutrodyne and reversed feed-back method are fairly well known and have been described at length in various issues of RADIO BROADCAST. The reader is perhaps less familiar with the loss systems, the advantages of which have been strongly emphasized in recent experiments in this laboratory.

Loss methods of stabilization are just what the name suggests. Losses are introduced in the various circuits, in which there is present an oscillatory tendency, of such a magnitude that the surplus energy which would ordinarily be utilized

in starting and maintaining oscillations is harmlessly dissipated. At first, the general principle of the thing may appear all wrong. The idea of deliberately introducing losses seems contrary to the fundamental precepts of radio. To-day, much effort is made to reduce all losses in circuits through scientifically designed coils and condensers. However, losses can be made very useful and are quite justified when *properly* used for stabilization. In such arrangements the losses are so adjusted that oscillations are just a little more than stopped. This permits regeneration and a practical maximum in signal strength, sensitivity, and selectivity. (We write “practical” because all of these qualities become still more intensified when the circuit is oscillating—a condition, however, in which enjoyable reception is impossible).

Unfortunately, the introduction of even losses over the entire tuning scale is an ideal condition which, at its best, can only be approximated. The tendency to oscillate increases in any tuned circuit with the frequency. The lower the wave (the higher the frequency) the greater is this tendency.

STRAIGHT ABSORPTION

LOSS stabilization systems fall into two classes that we might describe as “straight absorption” and “differential ab-

In the R. B. Lab This Month

—A good method for stabilizing radio frequency amplifiers. A comprehensive discussion of simple and effective means of subduing undesired oscillations in your tuned r. f. set. This complete article is the outcome of a series of experiments in our laboratory.

—A brief description of a six-tube de luxe Roberts Knockout receiver, employing four stages of resistance-coupled audio amplification.

—Charging Edison element B batteries at high charging rates.

—Current carrying capacities of wire sizes in small transformers.

—Other items of helpful interest.

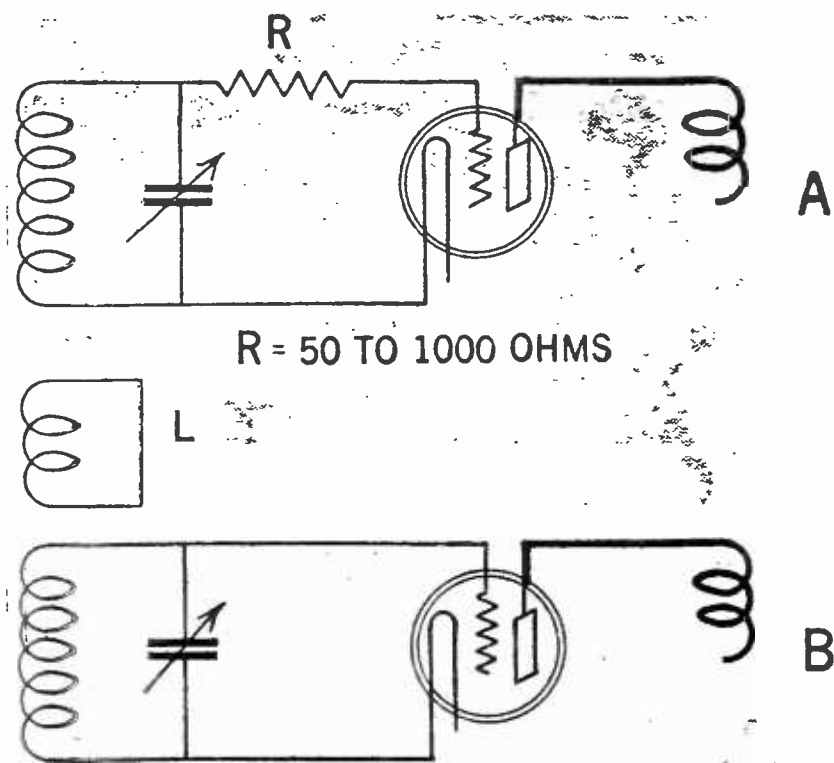

FIG. 1

Examples of straight stabilization

sorption." Straight absorption refers to systems that, without consideration of the changing tendency to oscillate, absorb over the full wave range. This arrangement is obviously very inefficient, for if the system is adjusted greatly to dampen oscillations on the higher frequencies, where a comparatively large amount of absorption is required it will dissipate much more power than is necessary on the higher waves, where almost any set is self stabilizing.

Examples of this type of absorption are numerous and are found in many amateur receivers and in a few commercial sets. The most common procedure is to place a resistance of from fifty to a thousand ohms in the grid circuit of the radio-frequency amplifier, (A, in Fig. 1). Another and widely advocated arrangement is to wind from two to eight turns of wire (L) with a diameter of about two to three inches, placing the coil close to the primary and secondary of the radio-frequency transformer (Fig. 1, B). As might be expected both of these systems work satisfactorily on the low waves where the losses are just sufficient to stabilize the receiver, regeneration with good signal strength and selectivity being permitted. However, on the upper side of the scale, the last trace of regeneration is dampened and the signal itself is absorbed. Variable controls, for obvious reasons, are only an impractical solution.

DIFFERENTIAL ABSORPTION

DIFFERENTIAL absorption refers to those systems that discriminate between the higher and lower wavelengths, and more or less adjust the amount of absorption in proportion to the tendency to over-regenerate and

oscillate. Such a system will absorb considerable power on the high frequencies, and practically none at all on the low frequencies, which approaches the ideal condition outlined a few paragraphs above.

A most simple and illustrative example of differential absorption is found in a slight modification of circuit B in Fig. 1. If, instead of short circuiting the terminals of the stabilizing coil L, a fixed condenser is shunted across it, as in LC of Fig. 2 (A), an oscillatory circuit will be formed which will absorb energy only about the wave to which it is tuned. If LC is given a resonance or tuned point at about two hundred and seventy-five meters, it will absorb sufficient power to stabilize the receiver on the short waves, having little or no effect on the higher waves where external stabilization is not required. This is the system first introduced by Austin, in 1916, for the control of oscillations in long wave heterodyne reception, later used by Mr. L. M. Cockaday in a receiver designed by him. This method is at present employed in the two-stage r. f. "Starr" set.

The method just described is probably the most efficient of all absorption methods, and is very easily applied to any r. f. receiver in the course of construction or quite completed. It is only necessary to wind the absorption coils and place them in inductive relation to the secondary. The calculation of the correct number of turns is not difficult.

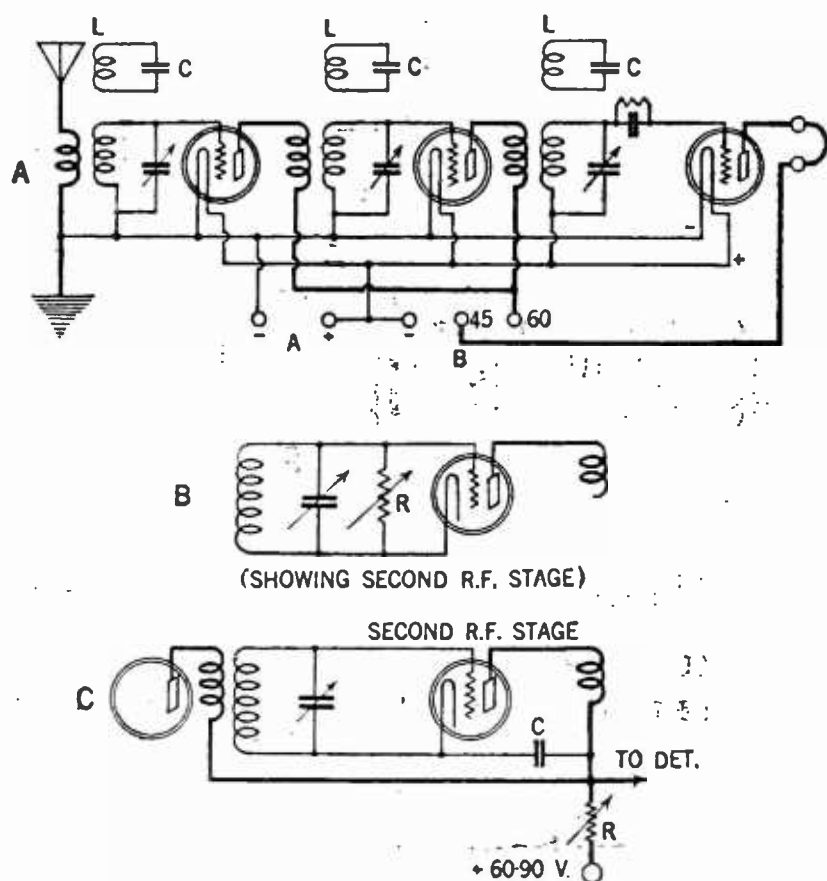

FIG. 2

Preferred and efficient methods of stabilization. The series resistance system (C) reduces the B battery consumption of the r.f. tubes, adding economy to its other desirable characteristics

It is assumed that the resonant absorption coil will be wound on a form approximating the diameter of the secondary, perhaps alongside the secondary, or on a tube that may be slipped within the grid coil. This being the case, the absorption coil should be wound with one half the number of turns on the secondary, and the condenser C should have a value of .00025 mfd. A Micadon will do nicely. This method of mounting the coil and condenser is illustrated in Fig. 3. The absorption coil has been wound alongside of the secondary.

The absorption coil should be wound with no smaller than No. 26 wire. The differential effect is curiously curtailed by the use of very small wire sizes, for the high-frequency resistance of the wire increases with the frequency, which appreciably cuts down the absorption where it is most wanted. In a few cases when the absorption coil tunes over sharply, that is when the circuit oscillates above and below the maximum absorption point, the difficulty can be remedied by winding two or three turns of the coil with resistance wire from a rheostat. This added resistance tends to increase the decrement of the absorption circuit making it tune more broadly, which allows the receiver to cover a larger wave band.

It is advisable to experiment with the coupling between the resonant absorption coil and the receiving circuit. When properly adjusted (though the adjustment is not critical and is easily effected), the set can just be

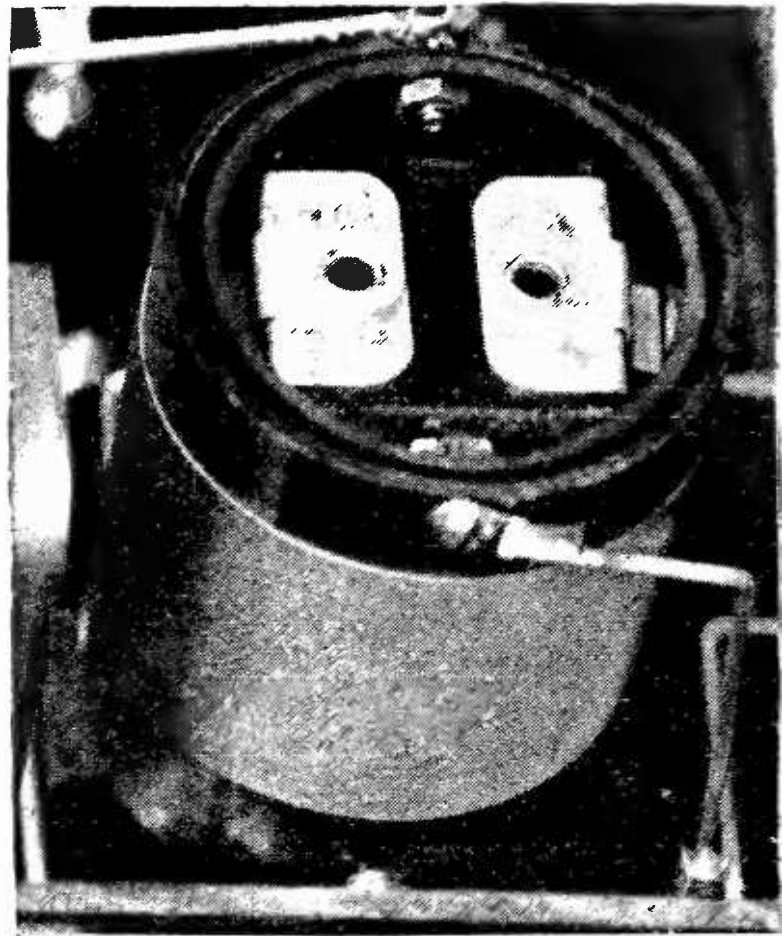

FIG. 3

A tuned radio transformer on the primary of which a stabilizing coil has been wound. The shunt condenser fits nicely within the tube

made to oscillate by filament rheostat variation, thus permitting regeneration control that is very desirable and effective. When oscillations occur on such an adjustment they are almost invariably generated in the second tube, seldom, if ever, in the first bulb. Ape-

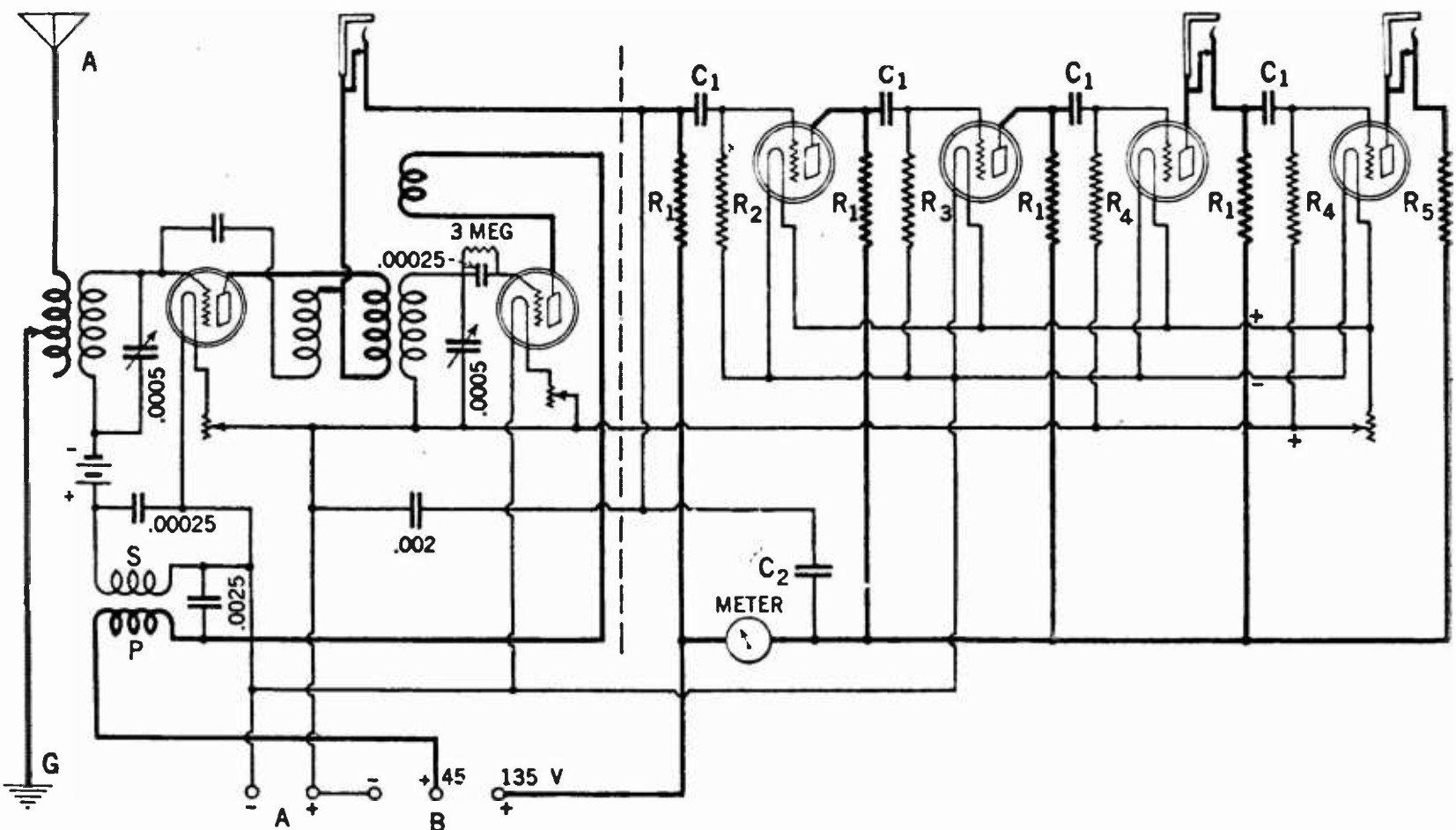

FIG. 4

The circuit of the de luxe six-tube Roberts Knockout receiver

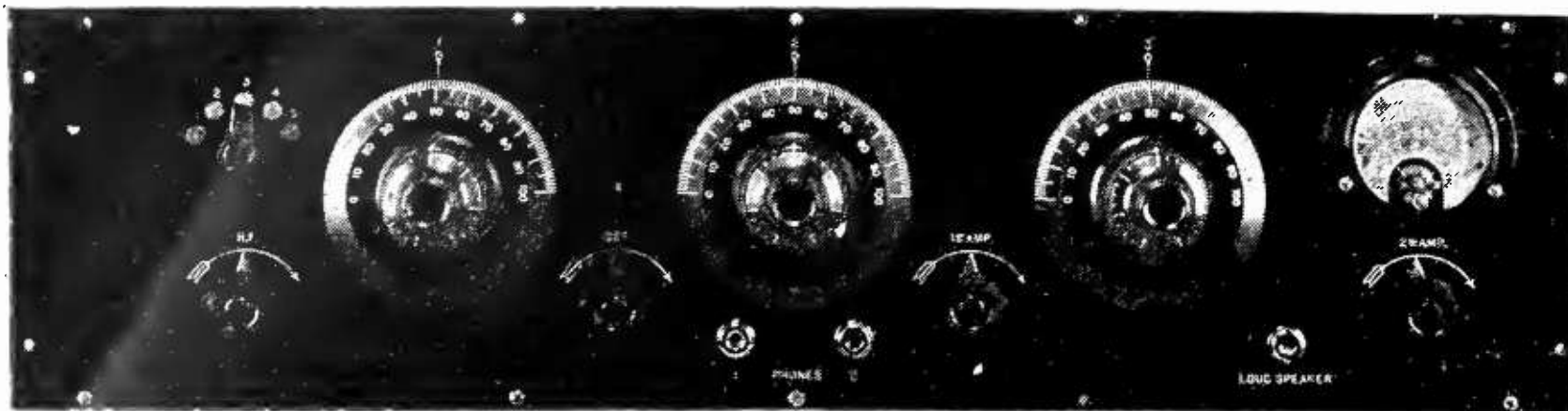

FIG. 5

Front view of the Roberts de luxe receiver. The meter is in the plate circuit of the audio amplifier

riodic primaries are usually found on tuned radio-frequency receivers, which have an actual tuned or resonance point on the low waves which act as an additional absorption circuit at these high frequencies, choking the tendency to oscillate.

In a two-stage tuned r. f. amplifier, the resonant absorption coils should be used in the first and second stage, and in the detector circuit. In receivers already completed, it may be most convenient to wind these coils on separate forms, mounting them in the ends (grid or filament) of the r. f. transformers.

Another interesting, though slightly inferior, method of differential stabilization is the shunting of high resistances (R) across the r. f. tuning condenser (in Fig. 2, B). This has the effect of increasing the "phase difference" of the circuit. The phase angle (unfortunately a rather technical consideration) is a determinant of the power loss in any circuit which increases with the frequency. Hence, the loss will be greater on the higher frequencies or lower wavelengths.

On two stages of tuned radio-frequency amplification, the resistances across the first

and third (detector) condensers may be fixed resistors, of the Daven type, having an ohmage of fifty thousand. The resistor across the middle condenser controlling, as we have demonstrated, the least stable of the three circuits, should be a Bradleyohm, having a variable resistance of from ten to one hundred thousand ohms. This, again, will provide the desired regeneration control.

Another very interesting and efficient method of stabilization, though not strictly a loss method, should be considered by the experimenter studying these possibilities. For several reasons, the tendency of a circuit to oscillate, or to become unstable, increases with the plate voltage. Hence, in any fairly stable circuit, for instance, an average r. f. circuit, a gradual reduction of the plate voltage to just below the critical point provides an adequate and efficient method of regeneration control. This principle is employed in the Deresnadyne receiver and in others of similar design. This idea is illustrated in Fig. 2, C.

The resistance R , a ten to one hundred thousand ohm Bradleyohm, adjusts the plate potential applied to the r. f. tubes and detector.

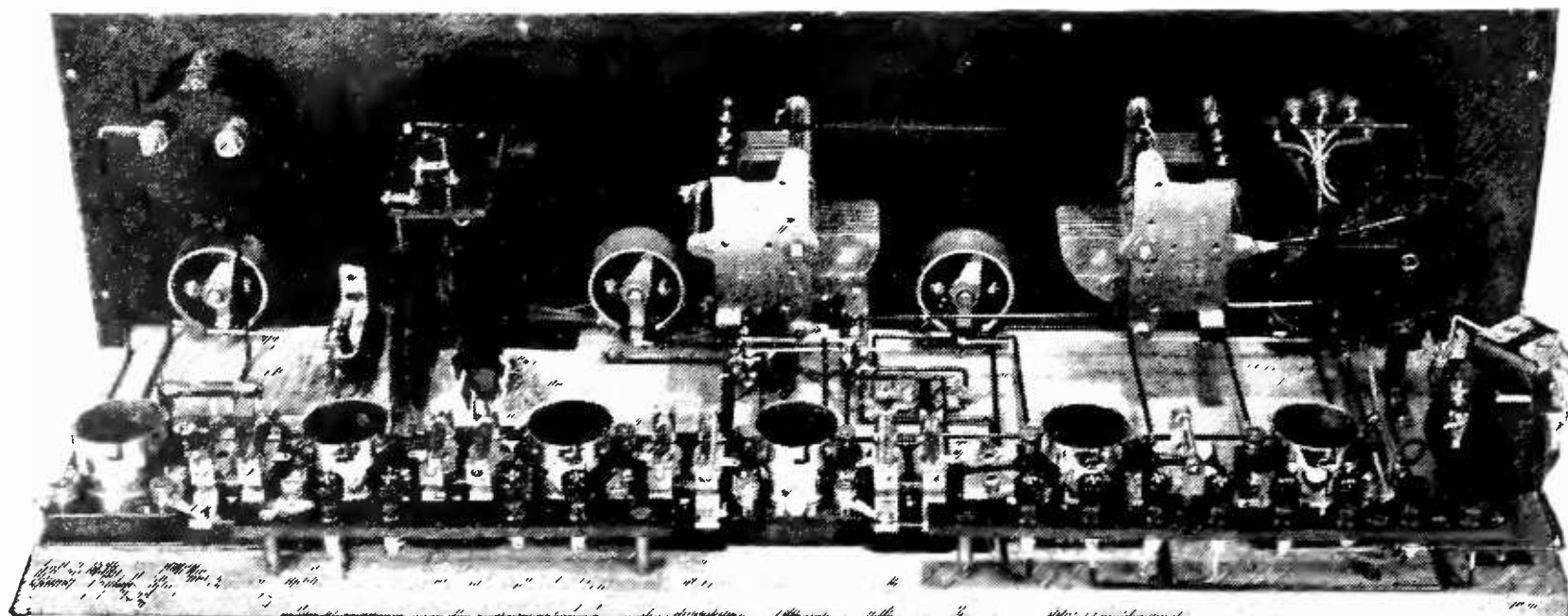

FIG. 6

Rear view showing construction

This resistance is bypassed by a 1 mfd. condenser C. The resistance probably also has a dampening effect on the radio-frequency fluctuations in the plate current, thus reducing feed-back through the capacity of the tube. Because of this, it is not necessary to reduce the plate voltage below the efficient operating potentials of the amplifying tubes in the radio frequency circuit.

A SIX-TUBE ROBERTS RECEIVER

FIGURES 4, 5, and 6 illustrate a special Roberts Knockout receiver built, from data supplied by RADIO BROADCAST, by Schneider and Horneij of New York.

The receiver employs the standard Roberts tuning arrangement followed by four stages of resistance-coupled amplification. The receiver is de luxe in every respect, only a few of the refinements being brought out in the photographs and diagram.

Referring to the diagram, Fig. 4, the apparatus to the left of the dotted line is identical with the usual Roberts equipment. C1 throughout the circuit, is a .012 mfd. fixed condenser. C2 is a 1 mfd. bypass condenser. Filament control jacks were used in the actual receiver, though for simplicity the auxiliary

contacts have been omitted from Fig. 4. R1 represents the coupling resistances, having a value of 100,000 ohms. Grid leak, R2 is a 500,000 ohm resistor and R3 a 250,000 ohm resistance. Grid leaks R4 are fifty thousand ohm resistances. R5 has a resistance of five thousand ohms. A meter, reading from zero to fifty milliamperes has been included in the plate lead to the resistance-coupled amplifier.

The following is a list of the exact parts used in the receiver described. Substitution of equally efficient apparatus will not affect operation.

- Bakelite Panel 7" x 27" x $\frac{3}{16}$ ", engraved
- 2 Cardwell .0005 Condensers.
- 6 Federal Sockets
- Amertran, 5:1 ratio
- 3 Federal Jacks (using 2 on tubes five and six)
- 3 Eztoon dials, 4"
- Nazeley Coil
- 4 G. R. Rheostats
- G.R. Switch and Points,
- Eby Binding Posts
- 4 Daven Resistor Couplers, Condenser Mountings, Leaks, etc.
- Dubilier Condensers, Pacent Balcon and Neutralizing Condenser
- Weston 0-50 Milliampere meter in plate circuit of Resistance Amplifier tubes only.

TABLE OF CURRENT CARRYING CAPACITIES OF WIRES USED IN WINDING SMALL TRANSFORMERS.

SIZE WIRE (B & S)	SAFE CURRENT WHEN WOUND ON	
	PRIMARY	SECONDARY
10	9.5	8.0
12	6.1	5.0
14	3.6	3.2
16	2.4	2.0
18	1.5	1.3
20	.96	.80
22	.60	.50
24	.37	.32
26	.23	.20
28	.14	.125
30	.095	.070
32	.059	.050
34	.037	.031
35	.023	.019

FIG. 7

These current carrying capacities are for transformer windings, and are considerably less than the safe limit for open wiring

WIRE SIZES AND CURRENT-CARRYING CAPACITY

THE publication IN THE R. B. LAB. for September and October, 1924, of data on the design and construction of small transformers, aroused considerable interest among our readers who are considering the construction of B battery eliminators and battery chargers. In the articles to which we refer, mention was made that the sizes of wires in the primary and secondaries would be governed altogether by the amount of current which they were to handle. For the benefit of our readers who have been puzzled on this point, we publish the table appearing as Fig. 7. Different sizes of wire, from No. 10 to No. 36 B & S gauge (A. W. G.) are given with their corresponding safe current carrying capacities in transformer windings. This data is sufficiently accurate and can be used without correction considerations in the construction of small transformers.

For example, we shall assume the experimenter desires to build a transformer operated from a 110 volt source for supplying plate potential to an amplifier. The maximum output will be forty milliamperes at three hundred volts. The secondary must there-

fore be wound with wire that will safely carry this current, and referring to Fig. 7 we find that this is No. 33.

Multiplying the volts, 300, by the amperes, .04, will give you the number of secondary volt-amperes. In a perfect transformer this would be exactly the volts-amperes inputted to the primary. However, efficiency must be considered, and so we multiply this VA rating 12, by 1.2 the product being close to the volts times amperes in the primary circuit. Therefore, primary volts multiplied by primary amperes equals 14.4, or $\frac{14.4}{110}$ is the number of amperes flowing in the primary under full load. The primary current then is .122. Again referring to the table we find that the correct primary wire is about No. 28.

In all cases, of course, a larger size wire may be used for convenience or other reasons.

LABORATORY HINTS

EDISON element storage B batteries can be charged at comparatively high charging rates without harm. Most B battery chargers using electric light bulbs as a series resistance only charge at a rate of about 75 to 100 milliamperes, which is quite correct for the majority of lead plate cells. However, on Edison cells this rate may be considerably increased by the substitution of a soldering iron or an electric iron for the lamp. Fig. 8 shows a commercial type of charger—the “Unitron”—an efficient bulb rectifier for charging both A and B batteries without the purchase of additional apparatus, charging a Todd B battery through a

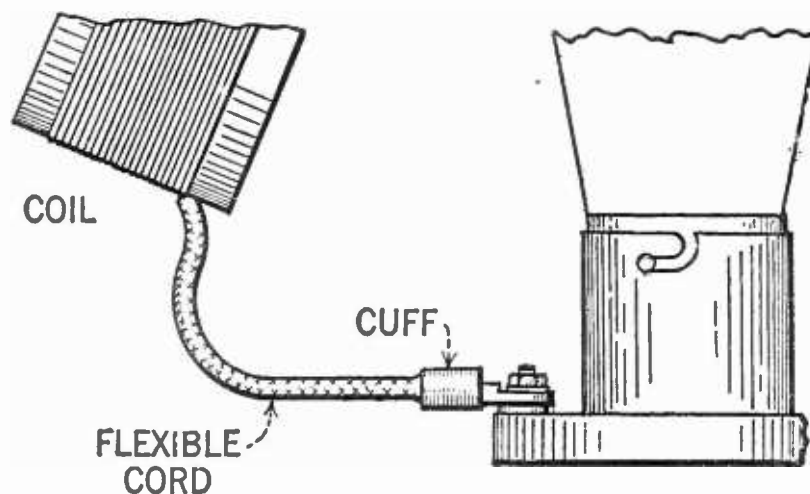

FIG. 9

A half inch of spaghetti keeps the silk from fraying

standard 500 watt electric iron. The complete battery is charged as a forty-five volt unit at close to a one-half ampere rate. Three hours running completely charges the battery, and after six months of repeated charging no ill effects of the comparatively high rate can be observed. If anything, the battery is in better condition than when originally obtained.

FIGURE 9 shows a wiring kink that solves in a neat and efficient manner the tendency of flexible cables to fray at the ends. Flexible wires, generally of the ordinary lamp cord type, are indispensable to the wiring of most receivers employing variable coupling, such as the Roberts. Moving coils are connected to the stationary bus-bars by means of these leads. If a small piece—a half inch or so—of spaghetti tubing is slipped over the ends of the flexible cables, forming a “cuff,” a permanently neat job is assured.

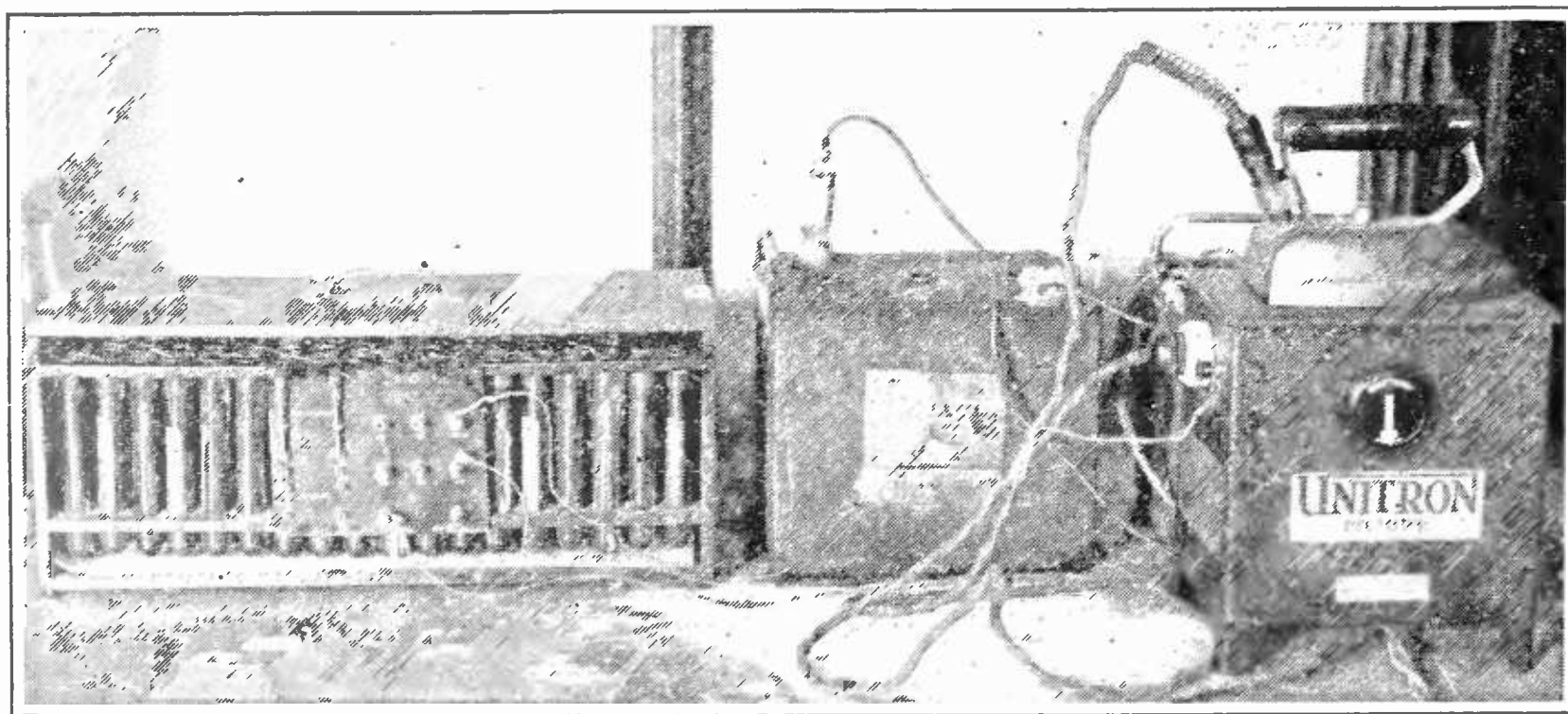

FIG. 8

A flat iron can be substituted for the usual carbon lamp when high charging rates are desired. An electric toaster will pass approximately the same current

How to Build a One-Dial Reflex Receiver

A Sensitive Non-Radiating Receiver Using Crystal Detection and Push-Pull Amplification which is Simple to Build and Operate—The Combination of Crystal and Push-Pull Produces Excellent Quality

BY JOHN C. DAVIDSON

THE receiver described in this article may very well be called universal. It is, in effect a one-, two-, or four-tube layout, depending on just how much the builder cares to do at a time. One may start with the single-tube layout and add the remainder at will. The two last tubes are used in a push-pull audio amplifier arrangement and are entirely unnecessary for loud speaker operation on stations up to several hundred miles—at night, of course.

In our tests of this receiver we operated a loud speaker on stations up to 300 miles distant with a single tube, up to 700 miles distant on two tubes, and on stations 1500 miles away with all four tubes. This is not guaranteed operation, but is not highly unusual operation. The selectivity is very good, though it does not equal the two- and four-tube Knockout receivers employing the Roberts circuit. There is but a single major tuning control. The receiver is very easy to build.

We suggest building the two-tube receiver first, because it produces enough volume for most purposes. If after trying two tubes, the music is not loud enough for dancing, the push-pull amplifier may be added.—THE EDITOR.

TWO years study of reflex circuits have brought out a number of interesting points about this popular method of radio reception. It is claimed that a circuit with one tube reflexed through a crystal detector will equal on distance reception, and at the same time give far more volume and better quality than the ordinary one-tube regenerative receiver. This additional energy gain is due to the fact that one tube reflexed, gives a stage of radio-frequency amplification, a certain amount of regeneration, which seems to be inherent in the majority of reflex circuits, and a stage of audio-frequency amplification. At the same time, there is a limit to what can be expected from one tube, and this makes the reflexing of more than one tube a questionable procedure, when using an antenna-ground system.

The circuit described here is a logical development obtained from a study of the above analysis. It comprises one stage of radio-frequency amplification with a stage of audio frequency reflexed through it, a fixed crystal detector, a second stage of audio-frequency amplification and finally a stage of push-pull

audio-frequency amplification. This combination gives plenty of loud speaker volume with local reception and good loud speaker volume for reception up to 1000 miles, it being understood that long range work is subject to seasonal and atmospheric conditions. At the same time, particular attention has been paid to selectivity, so that at least six or more distant stations can be brought in through the locals of the large cities. This performance is especially noteworthy in view of the fact that it is obtained with a single tuning dial and one volume control dial, which makes the operation about as simple as can be desired. Stations heard can be logged and returned to on their own dial setting.

THE CIRCUIT

THE circuit in principle can be best understood by referring to Fig. 1. Part of the radio-frequency tuning coil secondary is contained in the first grid circuit and the remainder of this coil is used in conjunction with the small balancing condenser "CB" to stabilize the circuit, and control the volume. It is the experience of the writer that the first audio

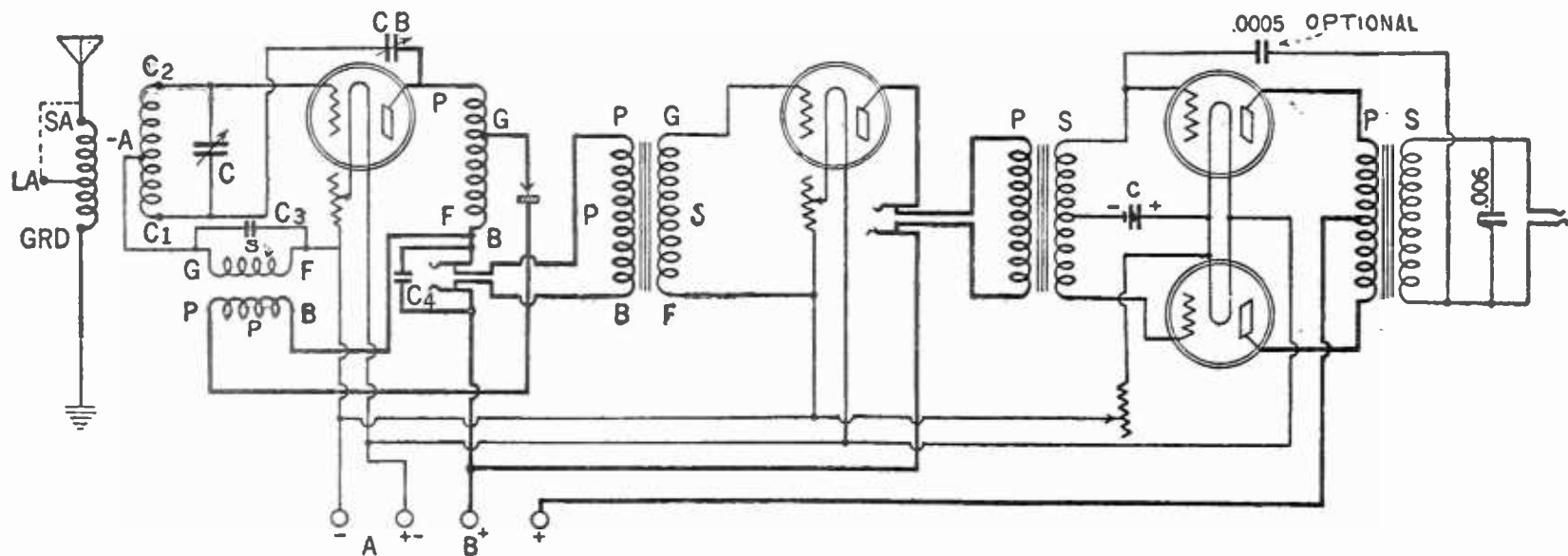

FIG. 1

The schematic circuit of the reflex receiver. The peculiar connection to the grid and plate circuits are especially to be noted. The constructional details are contained in the accompanying article. The radio-frequency transformer, shown in the diagram is completely illustrated in Fig. 3

transformer should have a ratio of the order of 10:1 to work best with the crystal. A small fixed condenser, "C₃" should be placed across the secondary of this transformer to bypass the radio-frequency currents. Its capacity should be .00025 or .0005 mfd. The condenser "C₄" is fixed, and may be as large as .005 mfd., and is placed across the two outside terminals of the double circuit jack, as a further by-pass. The second audio transformer should be of about 4:1 ratio for good quality.

The tuning unit used here is the result of considerable experimental work. It has a low distributed capacity and at the same time the three coils have a high degree of coupling.

In designing this unit the following conditions had to be met. The circuit must be able to oscillate over the entire range of broadcast wavelengths, with a fixed winding radio-frequency transformer in the plate circuit of the tube. By means of the balancing condenser and part of the secondary coil, these oscillations must be balanced out. At the same time, a high degree of selectivity must be maintained.

The tuning coil is of the fixed coupler type with an untuned primary and a tuned secondary. The primary has one tap to be used with a long antenna. The tuned secondary has a tap so placed that one part of the coil is included in the grid circuit, while the other part acts as a balancing-out or compensating coil. When used in conjunction with the balancing condenser "CB", all regeneration can be controlled.

The coil winding data for the tuning unit is outlined below:

Size of Tubing:—2" long x 1 $\frac{3}{4}$ " diameter.

Coil No. 1 consists of 21 turns tapped at the 16th.

Inside turn connects to grid 16th to LA and 21 st to SA.

Coil No. 2, 35 turns, outside lead to C₂, inside lead to —A.

Coil No. 3, 25 turns, outside to —A, inside to C₁.

All the coils are wound with No. 26 d. s. c. wire on a form slightly greater in diameter than the tubing. The form has 19 spokes $\frac{1}{8}$ " in diameter producing a coil about $\frac{3}{16}$ " wide. The winding style is over two and under two spokes.

BALANCING CONDENSER

A PHOTOGRAPH of the balancing condenser is shown. It will be noted that this condenser is designed to have an extremely small minimum capacity. Unless this minimum capacity is very small, the circuit will be sensitive only over the middle portion of the broadcast wavelengths.

The small commercial condensers available were found to be unsuitable for this purpose, so that a special condenser had to be designed. Those who desire to make their own can do so with old parts on hand. The only conditions to be met are a low minimum capacity and a maximum capacity of about fifty micro-microfarads. "C" is a variable condenser whose capacity may be as low as .00029 mfd. and should be of fairly good design. This capacity is equivalent to 13 to 17 plates depending upon the make of the condenser.

THE DETECTOR

A FIXED crystal is used for the detector. Right here it may be advisable to point out a great weakness of the variable crystal detector.

A given setting of the detector introduces a certain resistance into the circuit. If the circuit is tuned and adjusted to a certain wavelength and the variable detector is then

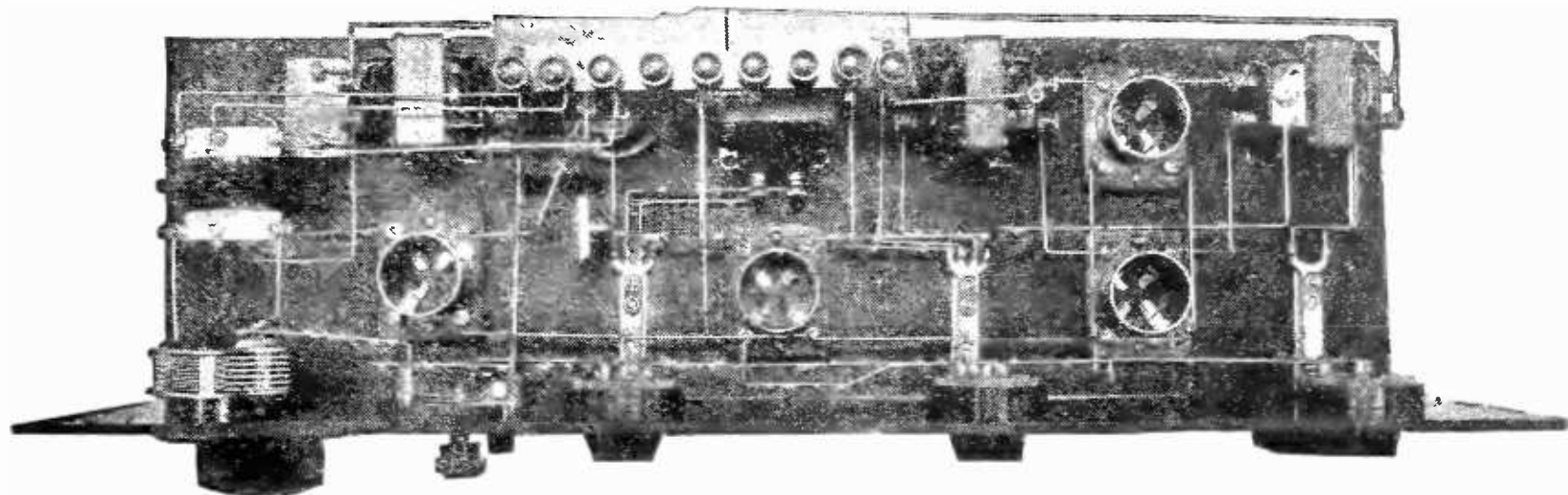

INSIDE

The "works." As can be seen, the wiring for this receiver is not difficult and the layout parts quite easy to duplicate

reset, a different resistance will be introduced necessitating a retuning of the entire circuit. This is particularly annoying if the station that is being received is a distant one. This difficulty is entirely eliminated when a fixed type of crystal detector is used.

THE RADIO-FREQUENCY TRANSFORMER

REFERRING to Fig. 1 once more it will be noted that the radio-frequency transformer used, is of unique design and is especially built to give maximum amplification over the broadcasting wavelengths when used between a tube and a crystal detector. It has a step down ratio and will not function between two tubes as is the case with the ordinary radio-frequency transformer.

Its construction is as follows:—

On a spool 1 3/4" in diameter and 5/8" wide, having a slot 1/8" wide and 1/2" deep are wound 170 turns of No. 35 wire.

First, 70 turns are wound in the slot and a tap

taken off which connects to G, then 100 turns are wound over this, the end connecting to P.

The beginning of the winding connects to F and B. See Figs. 1 & 3.

WIRING THE SET

FIGURE 2 is a picture drawing of the exact layout of the interior of the set and shows each piece of apparatus in relation to the other parts. It also clearly indicates the wiring. The panel size is 7 x 24" and is drilled according to the layout in Fig. 4. There are ten terminals at the back of the cabinet. Reading from left to right they are LA, SA, GND, —A, +A, —B, +B, +B, C+, C—. These terminals should be mounted on a bakelite strip and so supported that the terminals do not come in contact with the wood.

For the sake of simplicity, the wiring will be divided into four stages, namely, the filament wiring, the antenna-grid wiring, the reflex wiring and the audio-frequency wiring.

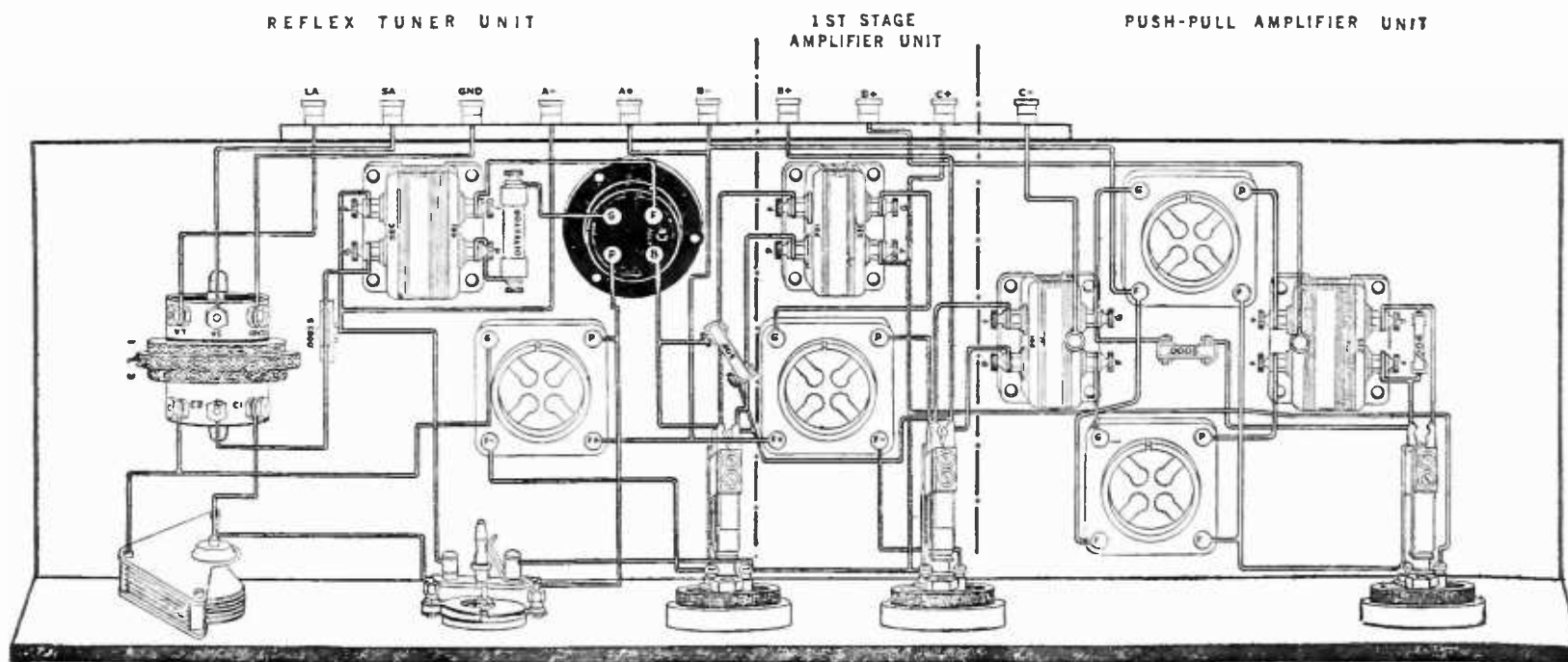

FIG. 2

A picture layout of the complete receiver

From the binding post marked "+A" run a wire to each socket terminal marked "+F". From the binding post marked "-A" run a wire to one terminal of the filament switch. From the other switch terminal run a wire to one terminal of each rheostat. The other three terminals of the rheostats are connected respectively to each socket terminal marked "-F". The filament circuit is now completed. As each wire is put in place it is well to mark it off on the circuit diagram with a red or blue pencil.

The antenna-grid circuit is wired as follows: Run a wire from the tuner terminal marked

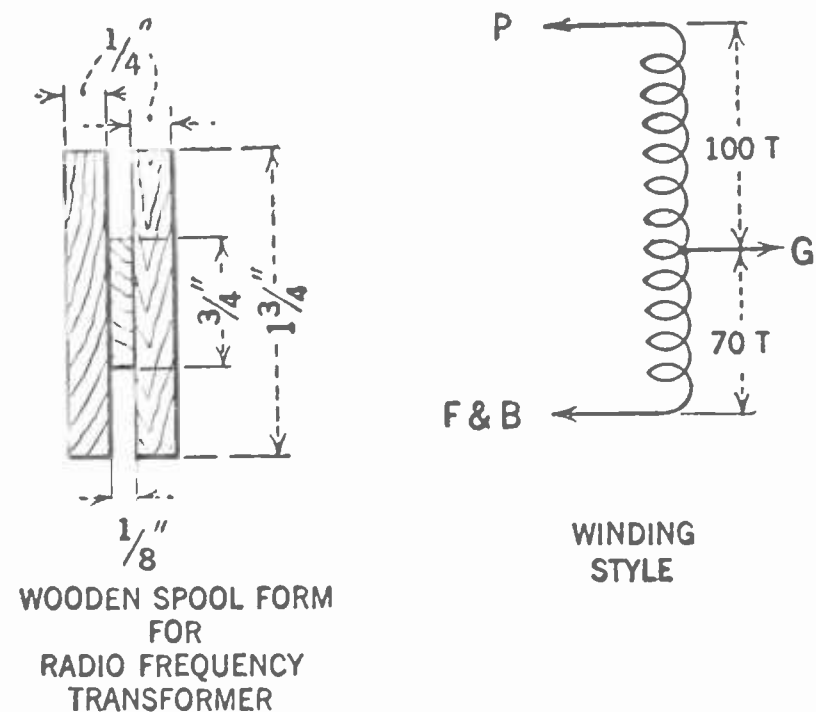

FIG. 3

Constructional and winding details of the special radio-frequency transformer

"LA" to the left hand binding post which should also be marked "LA" (long antenna.) Run a wire from the terminal "SA" to the binding post to the right of the one marked "LA." This binding post should be marked "SA" (short antenna.) Then connect the terminal marked "GND" to the binding post to the right of the one marked "SA." This binding post should be marked "GND" (ground). This completes the antenna-ground connections. The grid circuit is wired as follows. Connect the tuner terminal "C2" to the stationary plates of your thirteen or seventeen plate condenser, and connect the terminal "C1" to the rotor plates. Then run a wire from "C2" terminal to the first socket terminal marked "G". Connect the tuner terminal marked "-A" to the secondary terminal of the high ratio audio transformer marked "G." The "F" terminal of this transformer secondary is joined to the wire from the "-A" binding post. A small fixed mica condenser (.00025 or .0005 mfd.) should

be connected across the secondary terminals of this audio transformer. There remains only the compensating condenser, the rotating plate of which is connected to the first socket terminal marked "P" while the stationary plate is connected to the tuner terminal "C1". This completes the grid circuit.

All these connections are clearly shown in Fig. 2 together with the general shape of the wires, and by following the drawing the problem becomes fairly simple.

The reflex circuit is wired as follows. Connect the first socket terminal marked "P" to the "P" terminal of the radio-frequency transformer. The "B" terminal of this transformer is connected to the upper terminal of the double circuit jack. The bottom terminal of the double circuit jack goes to the binding post at the extreme right and should be marked "+B". A fixed mica condenser C4 of .005 mfd. capacity should be connected across the two outside terminals of the double circuit jack. From the "G" terminal of the radio-frequency transformer, run a wire to one end of the fixed detector. The other terminal of the fixed detector is connected to the primary terminal of the high ratio audio transformer marked "P." The "B" terminal of this audio transformer is connected to the "F" terminal of the radio-frequency transformer. The reflex circuit is now completed,

From the double circuit jack terminal next to the top, run a wire to the low ratio audio transformer terminal marked "P." The remaining double jack terminal is connected to the "B" terminal of the low ratio transformer. Join the "G" terminal of this transformer to the second socket "G" terminal and connect the "F" terminal of the transformer to the wire coming from the "-A" binding post. Connect the "P" socket terminal to the *bottom* terminal of the next double circuit jack. The top terminal of the second jack goes to the "+B" binding post. The wiring is completed by connecting together the binding posts marked "-B" and "+A."

ADDING A PUSH-PULL AMPLIFIER

SOONER or later, into the life of every real radio fan comes the desire for more volume and then comes the hunt for a means of amplification.

Though both the one-tube and the two-tube units of this reflex circuit afford good volume on all average reception, there are many who want more. But how to get this additional volume has been more of a problem than would at first glance appear.

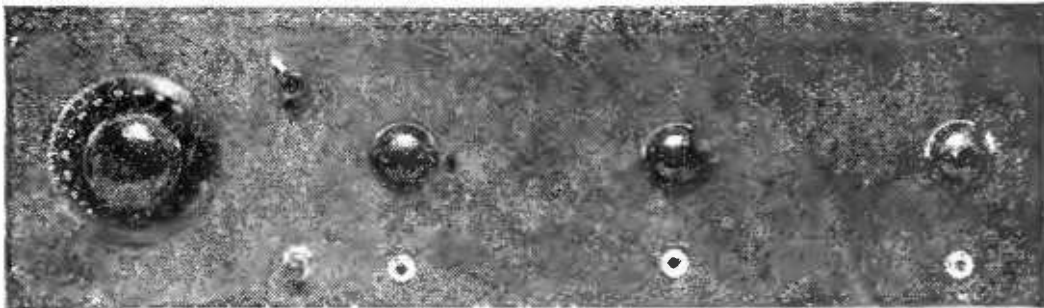

FRONT VIEW OF THE PANEL

With the one-tube reflex unit, the problem can be solved by the addition of another tube as an audio-frequency amplifier. It has proved highly impractical to add another audio-frequency tube to the two-tube circuit. One transformer and one tube alone have been unable to handle the output of the preceding two tubes without much distortion. So push-pull amplification has been a life saver—or shall we call it a volume saver?

Push-pull amplification is a necessity when additional volume is desired.

The "how and why" behind push-pull amplification is not half as intricate as some people seem to believe. It differs from the usual straight audio, at first glance, in that two transformers and two tubes are used for each stage. The first transformer is the coupling transformer which divides the output of the preceding tube evenly between the grids of the two push-pull tubes. The second transformer collects the outputs of the two push-pull tubes and passes the total energy on to the loud speaker.

The term "push-pull" is used because the grids of the two tubes in each stage of push-pull amplification are charged with opposite polarity at any instant. While one grid is positive, the other is negative. Any tendency to distort in one tube is counteracted by the other tube.

The first transformer performs the double duty of dividing the input current between the

two tubes and of delivering it to these tubes in such a manner that the two grids will be oppositely charged. It does this by means of a split winding. While the primary winding is one continuous winding coming out to two binding posts in the usual manner, the secondary is tapped at its central point and is therefore brought to three binding posts. The binding post leading to the center tap is connected to the negative A battery through the C battery. The other two binding posts are attached to the grids of the two tubes.

Conversely, the second or output transformer of the push-pull stage of amplification has a tapped primary and a conventional secondary. In this transformer the primary winding is brought to three binding posts and the secondary winding to two. In this case the central primary tap is connected to the B battery while the other two posts are connected one to each plate. The two posts of the secondary are connected to the speaker just as the two posts of the first transformer were connected to the plate and B battery of the last audio-frequency tube.

THE LAYOUT OF THE AMPLIFIER

THE layout of the push-pull unit can be made rather flexible. If space permits, the two tubes can be placed one in front of the other. The two transformers should be put one on each side of the tubes. This makes the wiring short and direct. It also reduces the

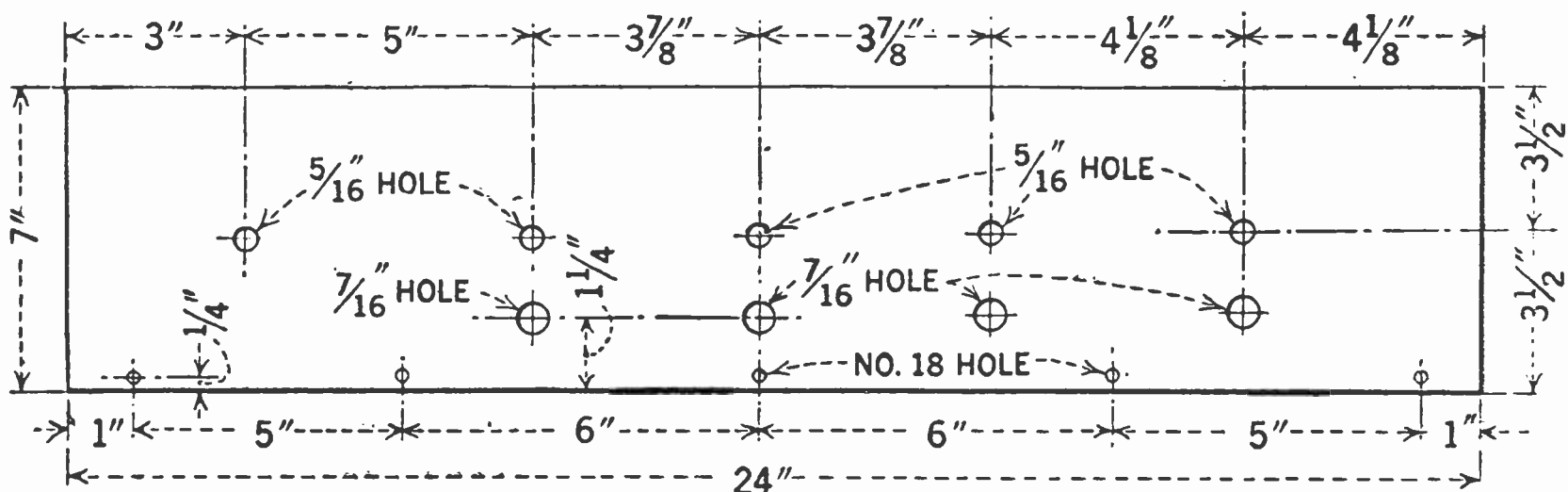

FIG. 4

The panel layout. The photograph above shows the appearance of the finished panel

chance of error, since the transformer and tubes, when in this position, almost connect themselves because of the proximity of binding posts to binding posts.

The two input or primary terminals of the first transformer are connected to the two central prongs of the center jack in the set. The outside terminals of the secondary are then connected to the grids of the two tubes, each to the nearer grid. The central terminal is run directly to the negative post of the C battery, while the positive post of the C battery is run to the negative A battery binding post.

The filament connections are made in the usual way, the two filaments being placed in parallel and being controlled by the one rheostat. The plate of one tube is connected to one of the two outside posts of the primary of the second transformer, the plate of the other tube to the other. The central binding post of the secondary is attached to the plus post of the high B battery voltage. The two secondary leads from the second or output transformer are wired to the push-pull jack. A .0005 mfd. fixed condenser C5 is connected from the upper grid side of the secondary of the input transformer to the lower side of the secondary of the output transformer as an additional stabilizing capacity. Various values of capacity may have to be substituted to obtain quiet operation.

In some cases it may be necessary to include in the push-pull amplifier circuit the .0005 mfd. fixed condenser shown connected between the G terminal of the secondary of the input transformer and the F terminal of the secondary of the output transformer. Usually its addition to the circuit will eliminate any tendency of the tubes to overload and the shunting of the .006 mfd. condenser across the secondary terminals of the output transformer will clarify the tone output of the receiver. This latter addition largely depends upon the type of loud speaker used.

PUSH-PULL AND THE LOUDSPEAKER

MOST loud speakers have an impedance out of all proportion to the impedance of the tube preceding. And yet theory has it that the best results are obtained when the impedance of the speaker or other "load" matches the tube impedance. The push-pull system corrects, or rather, overcomes this because the output transformer separates the loud speaker from the tube circuit.

The ordinary straight audio system places the loudspeaker directly in the plate circuit

of the last tube and consequently subjects it continually to the full plate voltage. This means that there is a constant drag on the diaphragm of the speaker which prevents that diaphragm from responding freely to weak or complicated tones.

In the push-pull system, the full plate voltage gets no farther than the primary of the second transformer. It cannot be transferred to the secondary or loud speaker circuit because it is a direct current. Direct currents do not affect a transformer. Only when there is a current fluctuation does the loud speaker winding get an impulse, because only then is the current transferred from primary to secondary by means of induction. It will be seen at a glance that this is the ideal condition. Unless speech or music is coming through the amplifier, the loud speaker has absolutely no potential applied to it, yet when broadcasts are being amplified, the loud speaker winding gets a powerful impulse exactly in accordance with the matter being broadcast.

SELECTIVITY

THE circuit described is extremely selective in spite of the fact it has but one tuning dial. Frequently on demonstration, seven or more out of town stations have been brought in on the speaker through the powerful New York local stations.

Referring to Fig. 2, it will be noted that there are three terminals on the primary side of the tuning unit, which are marked "SA", "LA", and "GND". The terminals "SA" and "GND" include the entire winding and should be used with a short antenna of from 40 to 100 feet. The terminals "LA" and "GND" include the larger part of the coil and should be used with a long antenna. If extreme selectivity is desired the antenna may be connected to "LA" and the ground to "SA." This uses only a small part of the coil and while the volume will be somewhat reduced, the tuning will be extremely sharp.

OPERATION

THIS receiver performs best with C-301-A DV-2 or UV-201-A tubes operating from a small six volt storage battery and 90 volts of B battery. At the same time good results may be obtained using a 201-A tube in the first stage and a UV-199 type tube in the second stage, running the two tubes from six volts of dry battery. If this latter method is used, the 30 ohm rheostat controlling the UV-199 type tube must be turned on only just

enough to light the filament or the tube will be burned out.

A negative C battery is used to cut down the B battery consumption and to improve the quality of signals through preventing distortion.

To operate at its best efficiency, the set should oscillate or be very near the oscillating point over the entire range of broadcasting wavelengths, when the balancing condenser is at its minimum. At this point the dial controlling this condenser should read 100 degrees. When this dial reads near zero, oscillations should not occur at any wavelength.

TUNING

THE method of tuning this set is very simple and can be mastered in a few minutes.

It will be observed that the large dial at the left is labelled "Tuning." The next dial to the right is labelled "Volume." To the right of the dial controlling volume are three rheostat knobs, which control the current in the filaments of the first, second, third, and fourth tubes. Immediately below the volume control dial is the filament current control switch. Continuing to the right of this switch and below the first rheostat knob is a jack for use of phones with only one stage of amplification. Then there is a second jack for the speaker, using both stages of amplification and the last jack employs all four tubes.

At first it will probably be best to try to tune the set with powerful near-by stations. To do this you set the volume control dial near zero and slowly rotate the tuning dial. Then having picked up a local station, by increasing the reading of the volume control dial, the signal should come in loud and clear. The setting of the tuning dial should be recorded and thereafter that particular station should always be found at that setting.

To obtain maximum volume on distant station reception the procedure is slightly different. In this case it is best to set the tuning dial approximately at the desired wavelength and for each of these settings increase the volume control dial until you get a hissing noise. If you go beyond this point you will get an audio note and the volume dial setting should be reduced. Generally

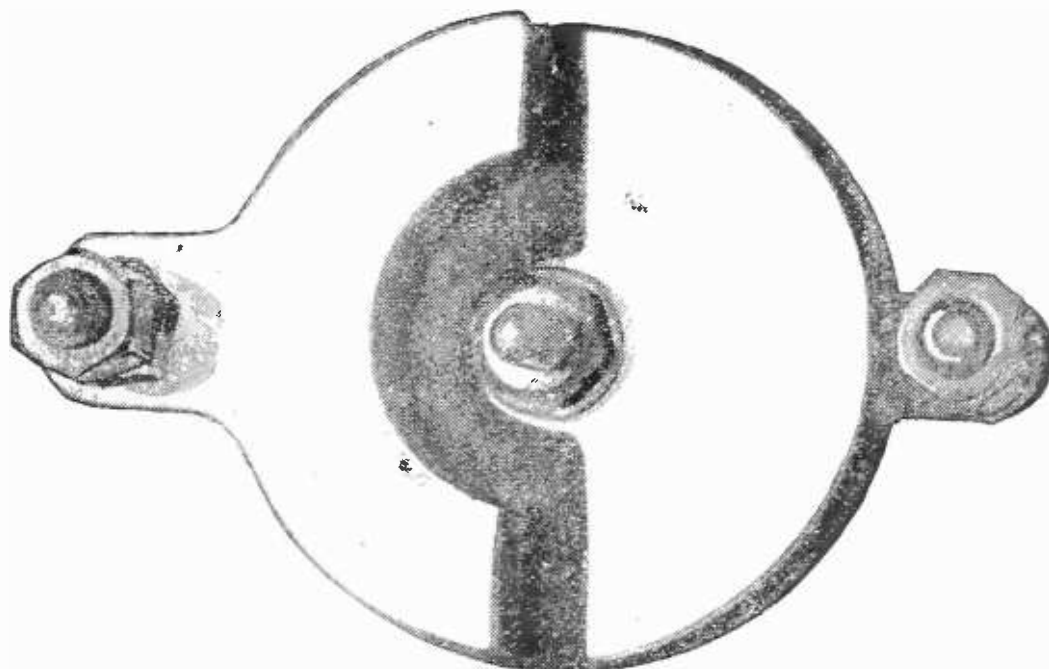

THE BALANCING CONDENSER

When fully opened as shown has a minimum capacity reading. The distance between the edges of the two plates is $\frac{1}{8}$ inch. The semi-circular movable plate and the narrow $\frac{1}{2}$ inch wide plates make up the full circular form $1\frac{3}{4}$ inch in diameter. The fixed plates are spaced $\frac{1}{8}$ inch apart and one semi-circular plate rotates between them. The plates are mounted on a bakelite base by means of bolts, spacers, and a shaft of the required thickness. All these parts may be secured from a radio shop with average stock.

speaking, for every setting of the tuning dial get the maximum setting of the volume dial.

The rheostats should be adjusted on a moderate signal until maximum volume is obtained. At the same time, for the sake of economy the tubes should be run no brighter than is necessary to give satisfactory performance.

The following is the list of parts for the four-tube circuit.

It is entirely possible to use any standard type of condenser, tube socket, jack, rheostat, etc., when building this receiver, and for that reason, no especial make has been listed. However, for the tuner and radio-frequency transformer units, it is well to use the same parts as specified in the article and used in the construction of the receiver described. If the reader wants to construct his own components, he can readily do so if he follows the constructional data given.

From the data given about the radio-frequency coil, it will be observed that this is no ordinary radio-frequency transformer, such as is used for the common radio-frequency amplifier, but must be especially constructed and connected in the circuit as shown in Figs. 1 and 3.—

THE EDITOR.

LIST OF PARTS

- | | |
|---|---|
| <ul style="list-style-type: none"> 1 Cabinet 7" x 24" 1 Panel 7" x 24" 1 Rasla Radio-Frequency Tuner—May be purchased, or home-made as described. 1 Variable Condenser .00029 mfd. (minimum cap). 1 Rasla Radio-Frequency Transformer—May be purchased, or home-made as described. 1 Fixed Crystal Detector 1 Modern 10-1 Audio Transformer 1 Modern Low Ratio Audio Transformer 1 Rasla Balancing Condenser—May be purchased, or home-made as illustrated. 1 Filament Control Switch | <ul style="list-style-type: none"> 4 Sockets 2 16-Ohm Rheostats 2 Double Circuit Jacks 1 Single Circuit Jack 1 Dial—vernier type preferable 9 Binding Posts 1 C Battery 1 Modern Push-pull transformer No. 112 1 " " " " No. 113 (Other makes may be successfully employed) 1 Fixed Mica Condenser .0005 mfd. capacity 1 Fixed Mica Condenser .006 mfd. capacity. 1 Fixed Mica Condenser .005 mfd. capacity 1 Fixed Mica Condenser .00025 mfd. capacity |
|---|---|

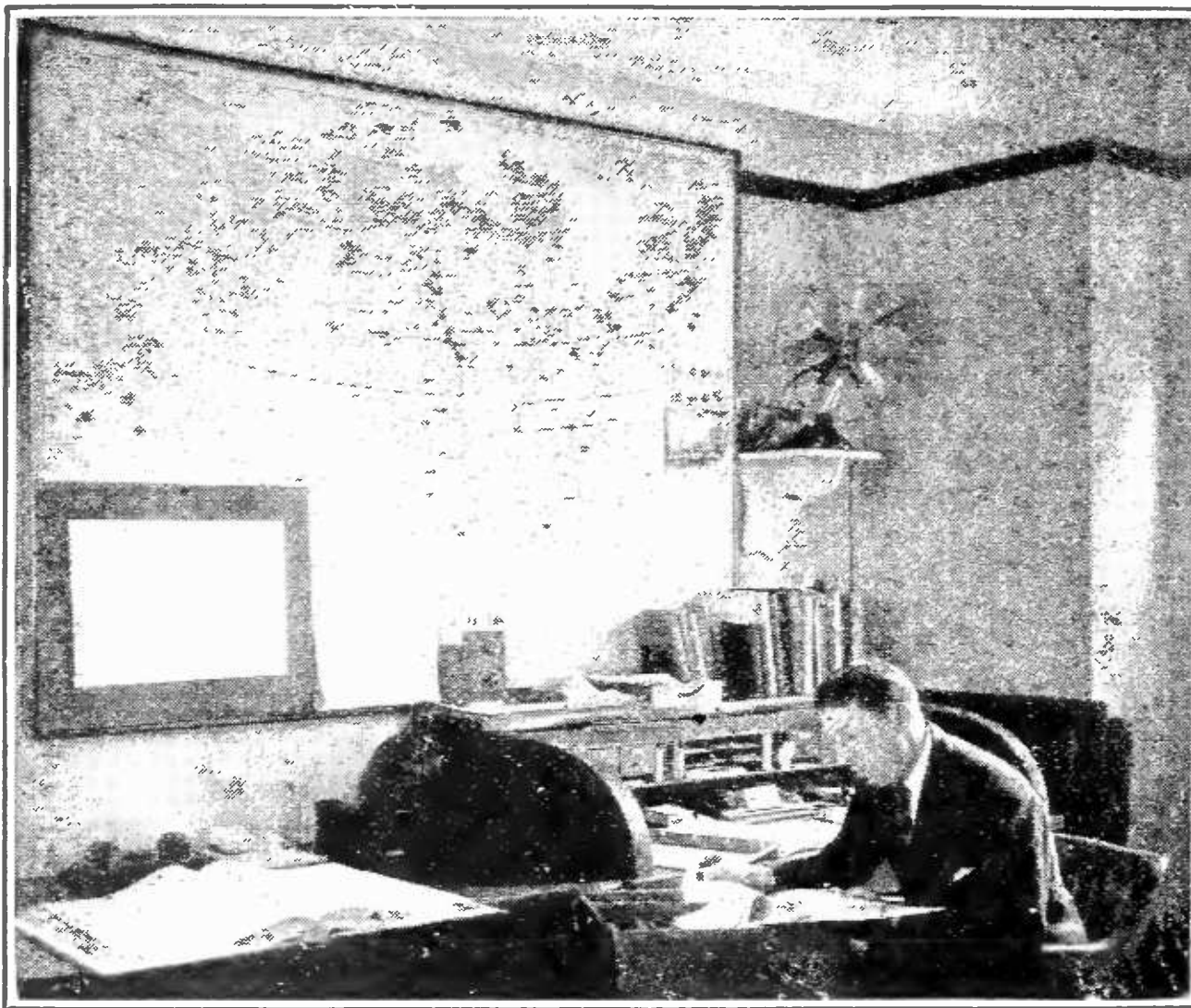

J. C. GILBERT

Who is in charge of the Department of Agriculture radio market news broadcasting system. The map on the wall shows the location of the broadcasting stations which the Department uses for this service

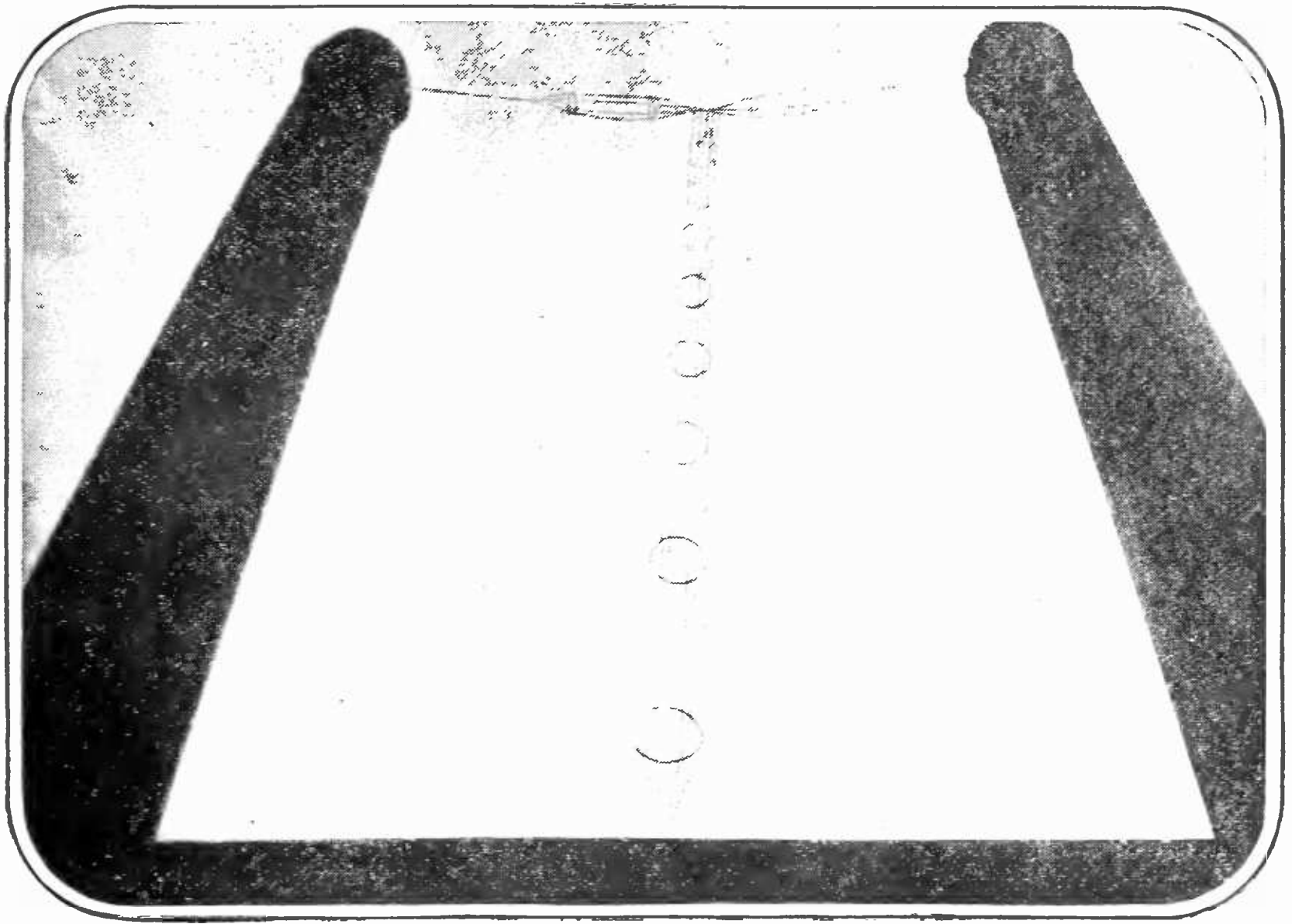

THE ANTENNA AT STATION 5IT, BIRMINGHAM

What We Are Doing With Broadcasting

The Chief Engineer of the British Broadcasting Company Compares English and American Broadcasting

BY CAPTAIN P. P. ECKERSLEY

Chief Engineer, British Broadcasting Company

I THINK we will all agree as broadcasters that it is certainly more blessed to send than to receive. But at this particular moment I do not know that I can agree with that sentiment either, because it is very difficult in a short time to give you an adequate picture of what we are doing on the other side. May I say that in trying to paint this picture I am only doing it with the idea of not vaunting it as the most wonderful thing that has ever happened, nor decrying it as the most miserable. But to show you how broadcasting has been misunderstood when comparisons between national systems have been

undertaken, I may state that I have read in some of your newspapers occasionally severe criticisms of your own progress and of ours; and I have seen foolish comparisons between the two. There can be no comparison at all, where the differences of areas are something like six million square miles as compared with a few hundred, and where there is a different temperament of the people to be considered, and different conditions in every sort of way.

In the first place, we were miles behind you. You started broadcasting long before we did. But the amateurs of England petitioned the then Postmaster General two years ago that

they should have some station which should transmit to them regularly. More than forty thousand people petitioned. Well, the Postmaster General graciously permitted that such a station should be erected and operated for a quarter of an hour once a week! Strangely enough, I was put in charge of this colossal undertaking, and broadcasting in England started in that way, in the year 1922. During that year we broadcast for a quarter of an hour a week, using Victrola records, and so on; while the transmissions, which were later treated in a less serious manner, because I was in charge of them, might have raised the enthusiasm of the amateur to a fever pitch they did not quite fulfill the more cultivated tastes of the high-brows of the radio profession, and as far back as that year, 1922, people began to realize that something must be done in England to put broadcasting on a firm basis. What they did was to have a conference which lasted exactly six months; and they finally came to a decision which was really a rather wise one, considering the nature of the problem.

EVERYONE IN ENGLAND WANTED TO BROADCAST

THEY said they all wanted to broadcast. The first idea was each one wanted to broadcast—newspapers, etc., and twenty-five applications came in to broadcast in London alone; and it was felt that would not work. So finally the scheme arrived at was that the six big manufacturers we have over there, who are called “the big six,” all came together and said, “We will put ten thousand pounds into the capitalization of the company, and this company will be responsible for nothing but the broadcasting. It will not be a profit-making concern in any sense whatsoever. It is simply and solely to send out the best programs possible.” They put in that money and they said, “If this thing makes a profit, we will limit our profit to seven and one-half

per cent. on our original investment. Nobody can take any shares in the company unless he is a bona fide British manufacturer.” Then, of course, the question was—The capital was sixty thousand pounds to start. Where would the revenue come from? The idea was that every person who made, bought, borrowed, stole, or otherwise got a receiver, would take out a license, because it was the rule of the country that he had to take out a

license. And of course everyone obeyed the law. In this law-abiding nation you all know about that! This license would cost ten shillings, of which the Government would have five shillings, and the company five shillings. And so we should have our revenue.

I will not tell of our various vicissitudes, or the troubles that resulted, or of the few licenses taken out, first of all, and the total inadequacy of the service, according to the press. At any rate, at the present day the scheme has worked out very well.

The first achievement

was, we got 7/6 (about \$1.75) from the Government, and they only took 2/6 (about \$.60). The second achievement was that the original rather hide-bound regulations were done away with, and one uniform license was issued, of which we got 7/6. In 1922 there were ten thousand licenses. When I left England we were getting up a special program to commemorate the buying of the millionth license. So the progress has been extraordinary, and our income about two million dollars a year. At any rate, we are spending every penny on the service, and we hope that, being able to spend all that money on the service, the programs can be made excellent, because you can afford to buy the very best talent, and you can afford to pay people just as if they were performing on a concert platform, and you are also able with this money to put up a fine technical scheme, having regard for the English temperament.

Where the Crystal Set Rules the Radio Waves

Britannia may rule the waves if one believe the anthem, but in English radio, it is the modest crystal set which marshals the radio wavelengths. The United States led the world in broadcasting, but England was really the second nation to follow. It is especially interesting to see along what lines British broadcasting has developed, because the two nations have a common bond of culture. Their method of payment for broadcasting is totally different from the American. And from some of the things Captain Eckersley says, in his decidedly humorous fashion, the English listener is quite different from our listener who uses “tubes” instead of “valves.” This story is taken from an address made by Captain Eckersley at the Department of Commerce Radio Conference in Washington, early last October.—THE EDITOR.

THE TECHNICAL EQUIPMENT

WE ERECTED eight main stations of the same power as your WEAf., etc., in New York. We had one and one-half kilowatts. These stations were erected, and dotted over England, to try to get uniform distribution throughout zones, just as you are doing.

Now the Englishman is a peculiar person, and having once got this scheme going, he does not keep on living seventy or eighty miles away from the station, and getting more and more distance. He does not care to reach out—I think you call it, nor has he the ambition of the man to reach Australia on half a valve. He is far more keen to get a pure, undisturbed signal, and he only hears the one single one coming from his local station. And our ambition is that any man in England can listen in on an apparatus made up of a clothes-line or a piece of string, and really hear his program uninterruptedly. And that is the way we have worked it out. The one ambition I have had is to give everybody so good a signal that they can not complain of the engineering side of it, but always must complain of the programs. I am not an engineer! Well, that ideal was not realized by the erection of the one and one-half kilowatt stations, because outside, thirty miles from that place, the service is not what we consider perfect, because it is liable to interruption. You know, in England we are all packed together, and there is a great deal of shipping, and they have not the wavelength allocations you have.

A Frenchman fishing off our coast will signal back and forth with his nearest home station about how many fish he has caught, and every time he tells about it, the while the fish constantly growing longer, he requires a longer message to narrate the thing. And so we must create much stronger signals perhaps than you have to use here. There were large areas in densely populated places where people could not receive; so we erected a royal station, designed to serve only the town or city in which it was located. We put these stations down, and it would be too expensive to provide programs every day up to the excellence of the programs we do provide in the large stations, so we linked these up by ordinary wire to our London program. But here is the difference in England: As technical men, responsible for the technique of our own station, we are not, of course, responsible for those trunk lines outside. I put a signal

on the wire, and the Government does the rest, and it sometimes arrives at the other end. As a matter of fact, the service, considering it has grown up in the way it has, is an extraordinarily good one.

Another function of the royal station is that you are able to give a local program from that station. Every city, of course, thinks it is just a little bit better than the next one, and if they can talk about it on their radio, it pleases them. So we give these stations over to local civic functions, etc. In Sheffield, they give the annual talk of the master of that city, or in Liverpool someone speaks treating of cotton prices, etc., all the things that appertain to the locality. They use that station to create local interest, whereas if there had been some impersonal, large, high-powered station, it would have bored Liverpool, for instance, horribly, to have to listen to the superlative merits of Glasgow or Manchester! So then we had the royal stations and main stations, and with that establishment, I estimate that, taking crystal reception as a basis, out of the forty-three million people we serve, exactly fifty per cent. could get a



TIME SIGNALS FROM "BIG BEN"

Are frequently broadcast from 2 LO, at London. The photograph shows engineers for the company, with a portable microphone, pulling in the sound. At the start and conclusion of some of the international broadcasting in November, time signals from this clock were sent out

signal on an ordinary simple crystal set; and they do. They use the crystal set to a man. You would be amazed to see the extent to which this simple set is used. I should think that the crystal set represents forty-eight per cent. of the fifty per cent. mentioned. Nearly everybody has a crystal set. They love it. They put it in the corner, and sit all night listening.

DEMOCRATIC BROADCASTING

BUT still feeling that broadcasting should be democratic so that anybody, anywhere, with anything to listen on, could get it, we came to the conclusion there were still large areas unserved by main or royal stations. We have just secured permission to erect a super-power station, to reach all areas not previously served by main or royal stations. This station, which has been running experimentally in England for the last three months, is a station of twenty-five kilowatts power, about twenty-two kilowatts in the antenna, at least so the designers told me. This station has a crystal range of exactly one hundred miles. It works on a wavelength of sixteen hundred meters, which was wrested from the Government under great pressure. We have found out the value of the longer wavelength in that you suffer neither from fading, night distortion, or jamming. The station does not send out stuff banked up in the middle and falling off at the ends, and at the long distances,

four and five hundred miles, the station is very adequate. I listened myself in Scotland, and with a single valve reaction I was able to hear that station every night clearly. The only trouble was static. And there's another slight trouble, and that is with the strength falling off slightly at night. But on the whole that station is very successful. And down along the coast we feel that we have solved our problem once for all, and everybody, everywhere is given a strong, adequate signal.

You may ask about the variety in the program. The variety is in the program. We block the program out to cater from the meanest intelligence up to the highest high-brow. We vary our selections from the more humble *Rhapsodie Hongroise* of Liszt up to the classical *Yes, We Have No Bananas!* We have tried to keep the *Yes, We Have No Bananas* side of the thing down just a bit, however, and our great criticism is that we are sending much too highbrow programs. Well, as a matter of fact, it is a subtle compliment to pay to anybody to give him something rather above him, and we have found it immensely successful.

SEVENTY PER CENT. USE CRYSTALS

WITH the high-power station, we may say that seventy per cent. of the population of Great Britain is served by crystal; and while the manufacturers may not be quite so pleased about it, at any rate the people whom we are serving are, and we feel that the manu-

facturer has got a great field, because he will be able to concentrate on the one thing that needs concentration, that is, the perfect quality, the perfect transmitting of sound between the studio and the drawing room or kitchen. That is what we are working on, not to listen to the distant signal, but more to get perfect programs, perfectly reproduced. And that is more or less the line that we are working on at the present time. We have a different problem, a different temperament, but that is what we are doing.

I should like to say a word on the linking up of the two continents. We did last year, as you know, broadcast probably more than



© Underwood & Underwood

LADY TERRINGTON

M. P. for Wycombe, Buckinghamshire, listening to a British Broadcasting Company program

any other organization has ever done in the world. We were trying to receive signals from America! We tried to pick up the various hundred meter stations, and occasionally a reply did come through, and occasionally we did have a sort of guessing competition as to whether it was a brass band or a piano. We did broadcast this, and it made a tremendous sensation in England; and on one particular and historic occasion signals from East Pittsburgh were received in England rebroadcast, and sent to South Africa, a distance of nine thousand miles! We do feel that the future of broadcasting must be intimately connected with the strengthening of friendly relations between the continents thus bound together by sound. And what could be more ideal than that America and England should be linked together by this mighty force, inasmuch as they are both English-speaking people, and they will probably, after a little practice, be able to understand one another.

There is no doubt, however, in the minds of engineers that there is only one thing to do if we are to link up the two countries, and that is purely on the engineering side.

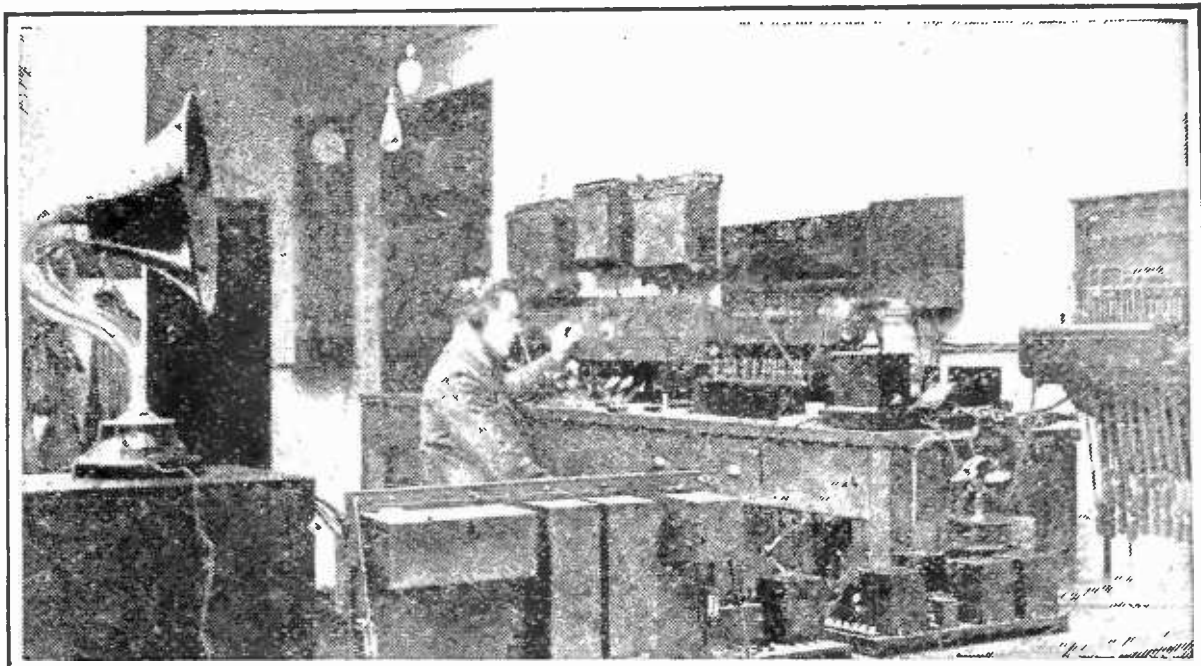

THE CONTROL ROOM OF THE BELFAST STATION

Call letters 2 BE, one of the newest of the British Broadcasting Company chain

It's an amazingly long way across the Atlantic. I have just crossed it. And it seems to me that to make that journey in $\frac{86}{1000}$ part of a second will take a great deal of push behind the traveler. And one thing we must concentrate on is the question of having high-power stations to link up the two continents. Of that there can be no possible doubt. We are absolutely ignorant of transmissions at long distances at night. But it seems to me that inasmuch as the amateurs of both countries have spoken to each other with about two watts, by c. w., as reported in our press, we feel that we can deal with 150 up to 200 watts, and it might be possible to get communication between the two countries; and if we did, it would stimulate a great interest on both sides of the water. If we could be certain on occasion of hearing some of your most interesting pronouncements, and you could listen to us drawing away, we would find that radio really had tremendous possibilities for good, and it would tend toward our understanding each other a little better than we sometimes do. And I think that, with the English-speaking people, at any rate, radio has a great future. It must be so.

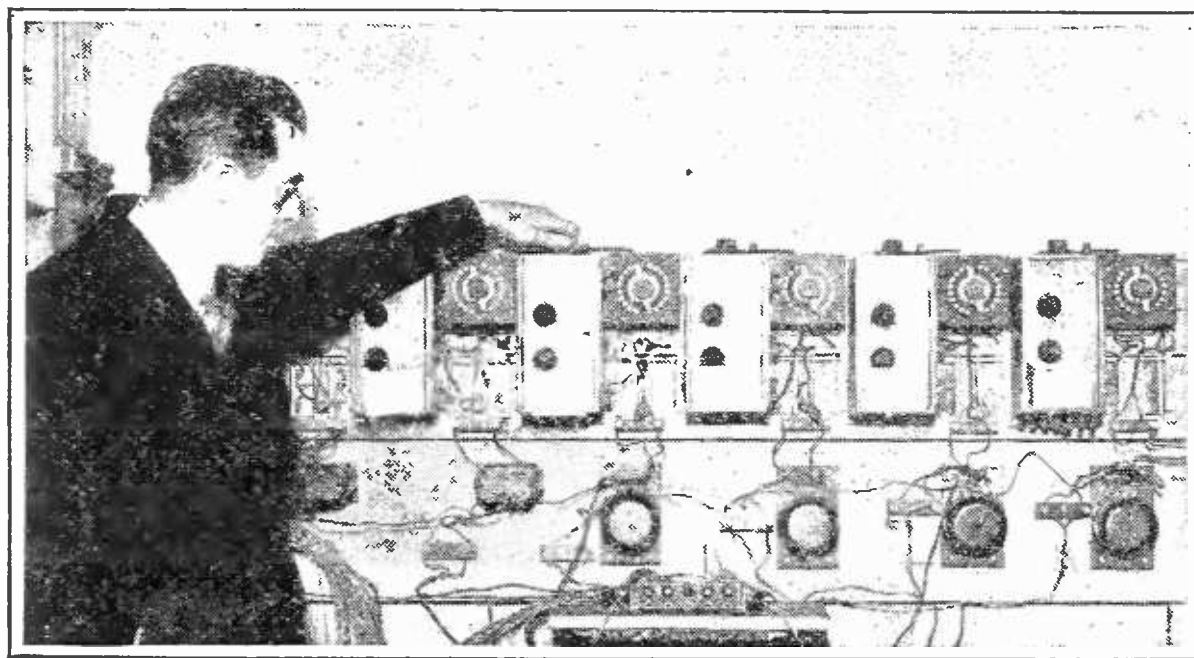

CAPTAIN ECKERSLEY

Chief Engineer of the British Broadcasting Company, at the relay apparatus in the London headquarters. Programs are frequently given in the London studio and relayed by wire to the other stations in the chain. The purpose of this is to allow the owner of a crystal receiver to hear strong signals from London. The apparatus in the photograph is necessary to "boost" the signal strength to overcome the resistance in the wire lines connecting the stations

The Decision in the “Who is to Pay for Broadcasting?” Contest

A Prize of \$500 Was Awarded to H. D. Kellogg, Jr., of Haverford, Pa.

FOR three months since the close of the contest “Who Is to Pay for Broadcasting?” the judges have been going over the great number of manuscripts submitted for the prize. Suggestions there were of all kinds, and the problem of deciding which one of all the group was the best was not found at all easy. The judges were carefully chosen to represent all branches of thought which could possibly be concerned with the broadcasting problem. They were, Professor J. H. Morecroft, president of the Institute of Radio Engineers (1923-4); Major J. Andrew White, former editor of the *Wireless Age* and well-known descriptive broadcaster; Harry Chandler, publisher of the *Los Angeles Times* and owner of KHJ; Frank Reichmann, a Chicago radio manufacturer and an old-timer in the field; Dr. Royal S. Cope-land, United States Senator from New York, representing the public point of view; A. S. Lindstrom, chairman of the Pacific Radio Trade Association; Zeh Bouck, one of the best known radio authors in America; and Charles H. Porter, Chicago, secretary of the Radio Manufacturers’ Association.

In the May, 1924, RADIO BROADCAST, the purpose and rules of the contest were announced. It was then said that “a workable plan which shall take into account the problems in present radio broadcasting and propose a solution” was desired. A plan was wanted which should propose a practicable and workable solution of the present complex radio situation. Very nearly one thousand manuscripts were submitted to the judges.

The complete prize-winning plan will appear in the March RADIO BROADCAST. In brief, it calls for the public to shoulder the cost of broadcasting by means of a stamp tax on each vacuum tube and crystal bought by the consumer for his radio set. Radio broadcasting, avers the author of the plan, should be placed on a sound economic basis and to be so, should pay its way, precisely as other forms of entertainment. In order that radio secure the best possible available entertainment, broadcasting should be put on a paid contract basis. Tubes have a life commensurate with the service they render, the prize-winner claims, which makes them an “index of broadcast consumption.” The number of tubes was considered to be an excellent index of the cost of the set and the distance over which it would receive. It was finally proposed that a newly created Bureau of Broadcasting administer the fund to be collected from this tax. Stamps purchased by the tube manufacturers from the Bureau of Broadcasting would be affixed by the manufacturer of the tubes, and the amount of tax to be paid would be determined from statistics compiled by the Bureau.

Neither the American Radio Association, under whose auspices the contest was conducted, nor RADIO BROADCAST which offered the \$500 as a prize necessarily concur in the suggestions offered by the winner, Mr. H. D. Kellogg, Jr., of Haverford, Pennsylvania.

Later numbers of this magazine will contain some interesting comments on this entire question of who is to pay for broadcasting.

A Winder for Small Inductances

How to Build and Use a Device to Wind Efficient, Concentrated Inductances Which May be Used in Various Radio Receivers—How to Wind the Coils for the RADIO BROADCAST Six-Tube Second Harmonic Super-heterodyne

BY ALLAN T. HANSCOM

MANY readers have been greatly interested in the second harmonic super-heterodyne described in RADIO BROADCAST for November, 1924. One of the central features of that six-tube receiver is the concentrated inductances. These are wound by a special machine which is described here. The construction of this device is not especially easy and had best be assumed by those readers who are adept at using a lathe and similar tools. In addition to the method of assembling the winder, complete information is given on the number of turns and dimensions for the intermediate frequency and oscillator coils for the six-tube, second harmonic super-heterodyne.—THE EDITOR.

SO MANY requests have come to the writer for constructional data on the small honeycomb coils which are used in the six-tube super-heterodyne described in this magazine for November, 1924, that a description of the method by which these coils are made should prove interesting.

In the first place, some of the more important requirements for any inductance to be used in radio work should be considered.

LOW DISTRIBUTED CAPACITY

DISTRIBUTED capacity in an inductance greatly increases the resistance of the inductance at the higher frequencies. The direct current resistance of an inductance is an inverse function of the wire size. By this we mean that the resistance of a coil of coarse wire is less than a similar coil of fine wire, but with coarse wire the distributed capacity in-

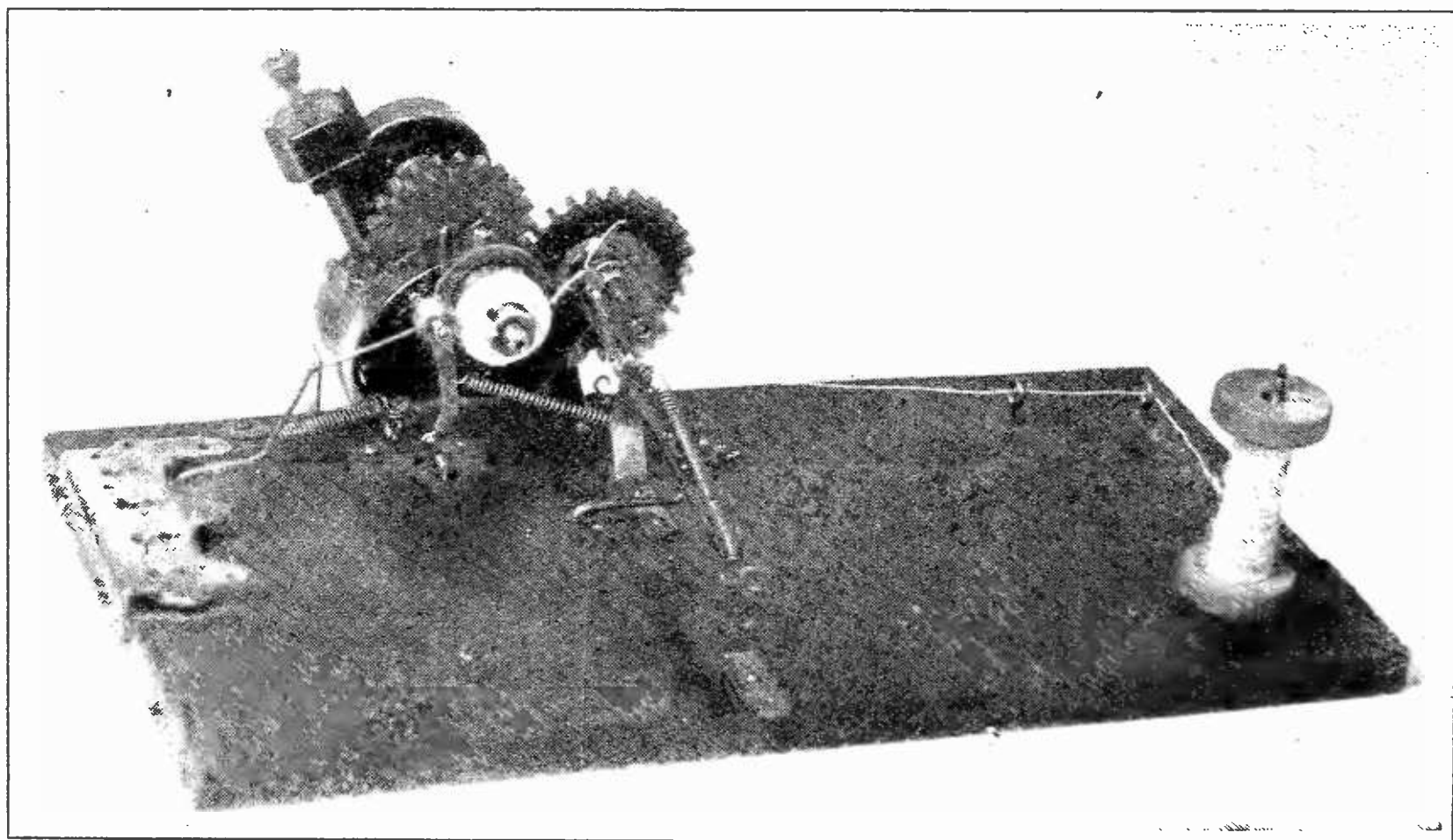

FIG. 1

A photograph of the completed coil winder

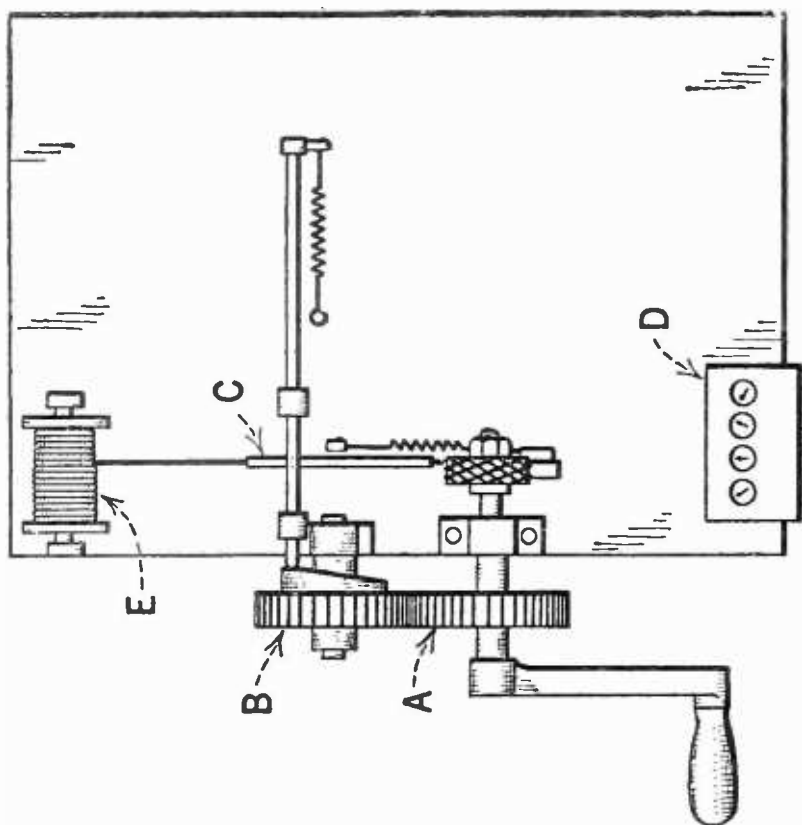

FIG. 2

The arrangement of the various parts on a baseboard. A coil gear; B nozzle feed gear; C feed nozzle; D turn counter; E spool of wire

creases so that the net gain is not as large as it would seem.

NUMBER OF TURNS

THIS depends entirely on the inductance value which we wish the finished coil to have and because the wavelength is proportional to the square root of the inductance (other things being equal). The number of turns depends entirely on the use for which the coil is designed.

SIZE OF COILS

NATURALLY, the factor of space has to be considered and a small coil is better than a big one, provided the efficiency is not sacrificed.

As applied to the super-heterodyne, the intermediate frequency which is created within the set and is used to amplify the signal is of such a value to make necessary large inductances. Small coils wound "scramble fashion" on wooden or bakelite forms are not practical because of the difference in inductance and distributed capacity between the coils, even though they are wound with the same number of turns. In endeavoring to solve this problem the writer devised the machine which is shown in the photographs. The essential features are illustrated in Figs. 1 and 2. It is apparent upon the examination of inductances like spiderwebs, lattice windings, and commercial honeycomb coils that the biggest gain results from the fact that the wires are not close together where they run parallel.

This results in a very much lower distributed capacity. Obviously, in order to wind a coil which shall be self-supporting, it is necessary that the feed for the wire should travel sideways back and forth while the coil is being wound. The relation between the speed of rotation of the coil and the speed of the side travel of the feed is what governs the angle at which the successive turns of the coil will intersect, if the nozzle which feeds the wire travels across the face of the coil and back to the original starting point in exactly one turn of the coil, then the wire will always fall in

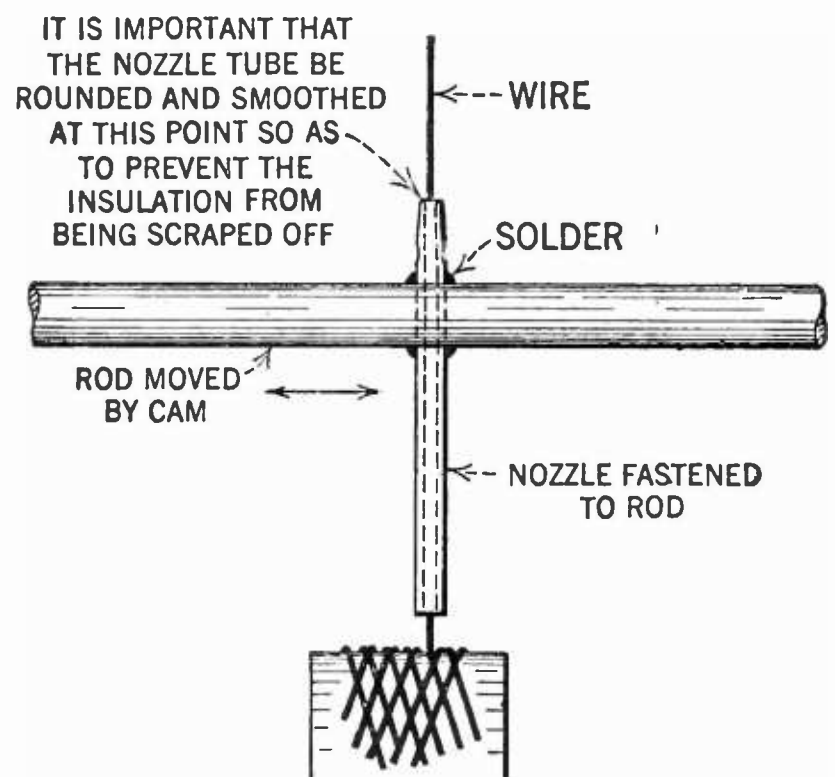

FIG. 3

Shows how the tubular nozzle is mounted and soldered to the cam shaft

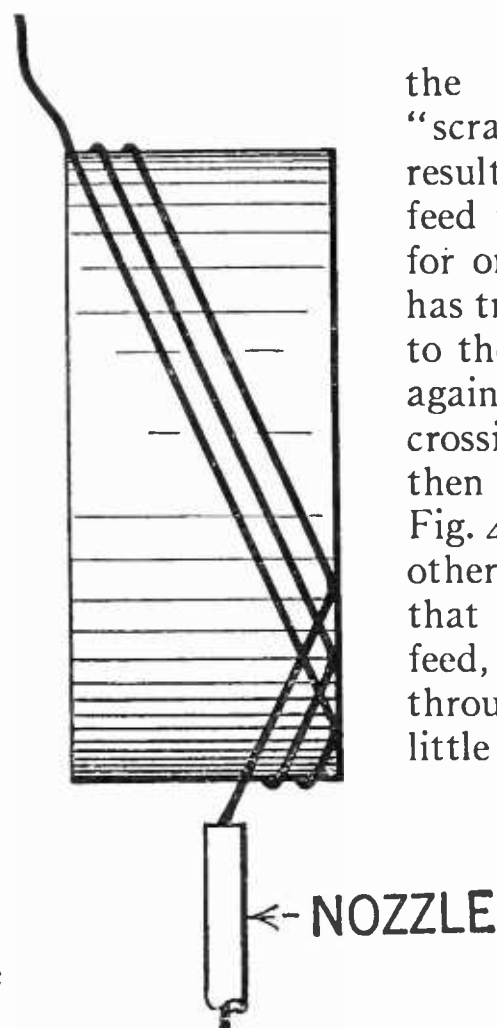

FIG. 4

The standard type of honeycomb coil winding produced by the coil winder

the same place and a "scramble fashion" will result. But now if the feed is adjusted so that for one turn of the coil it has traveled from one side to the other, comes back again but a trifle short, crossing the first turn, then the effect shown in Fig. 4 will be created. Another way of stating this is that for one cycle of the feed, the coil has rotated through one full turn and a little more in the winder.

As illustrated this result is obtained by the ratio of the gears A and B. The gear A being on the same shaft with the coil, its rotating is the same as that of the coil, while the gear B being larger than the gear A, turns more

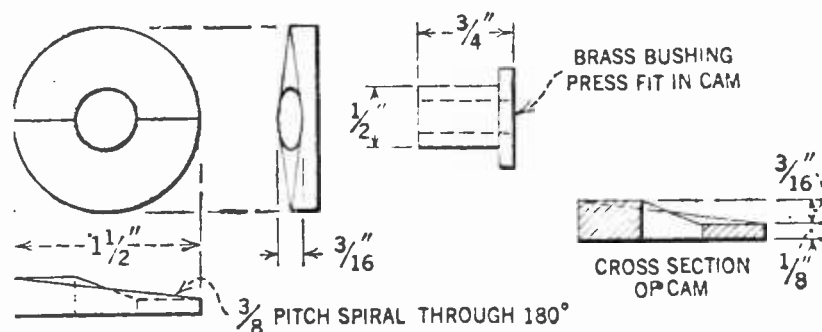

FIG. 5

A working sketch of the cam, the most important unit of the entire device

slowly. Fastened to the gear B is a cam which operates the nozzle C. The shape of this cam is very important. The rate of travel of the nozzle should be constant with practically no time-interval at the end of the travel when the direction is reversed. Therefore, the ideal shape of the cam is that of a straight spiral through 180° and the reverse spiral through the remaining 180°. There is absolutely no way that this cam can be cut except on an end milling machine with a double motion. Any up-to-date machine shop has this equipment and the actual cutting of the cam is a very short process after the milling machine is set up. Fig. 5 is a working sketch of this cam. Its lateral reciprocating action is plainly illustrated in Fig. 6.

THE WINDING MACHINE

OF COURSE, it is absolutely necessary that there is no end play in the mechanism. The shaft on which the coil is wound must run absolutely true in order to prevent

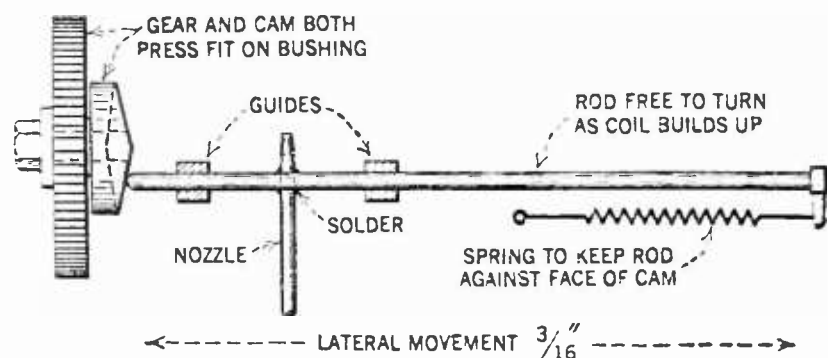

FIG. 6

Illustrates the function of the cam and nozzle

the wire from slipping on the edges of the coil while it is being wound. D in Fig. 2 represents a counter which counts the number of turns being wound. This is likewise almost a necessity because it is very easy to make an

error in attempting to count and wind by hand. The writer used a motor with a worm drive with a gear on the main shaft, but any form of drive would serve the purpose.

In using the machine, the wire is first fastened on the end of the shaft and allowed to wind twenty or thirty turns on the bushing D which is clamped on the end of the shaft with a nut. At this point the machine is stopped and a piece of adhesive tape 1/8 of an inch wide is laid across the bushing with the sticky side up as in Fig. 7. Then the counter is set at zero and the desired number

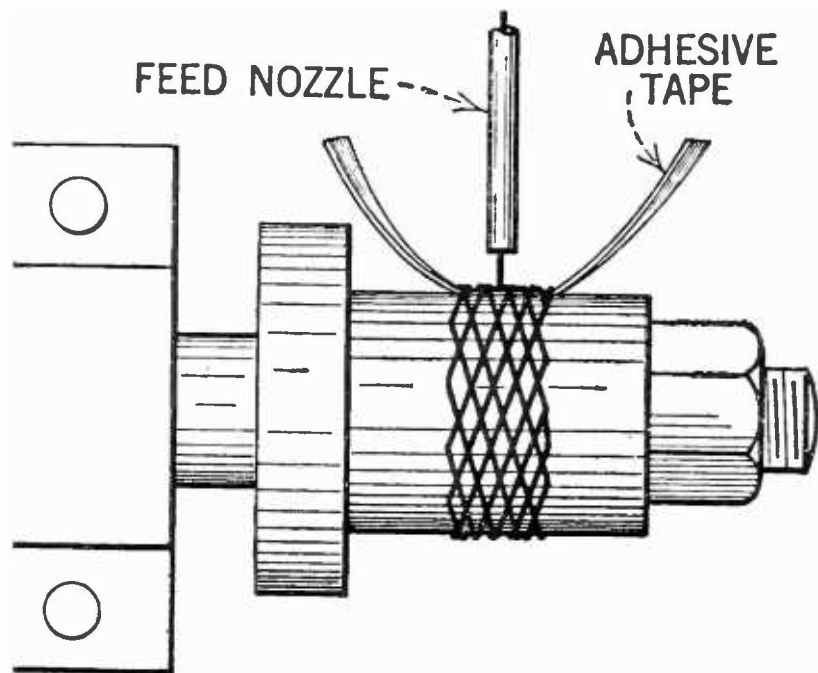

FIG. 7

Preparing the coil for binding with adhesive tape

of turns are wound on. After this, the adhesive tape is brought up over the outer edge of the coil to hold the last turn and the bushing with the coil on it is removed from the shaft. After driving the bushing out of the coil the first twenty or thirty turns are removed from the inside and the finished coil is dipped in a mixture of acetone and celluloid.

By varying the shape of the cam which con-

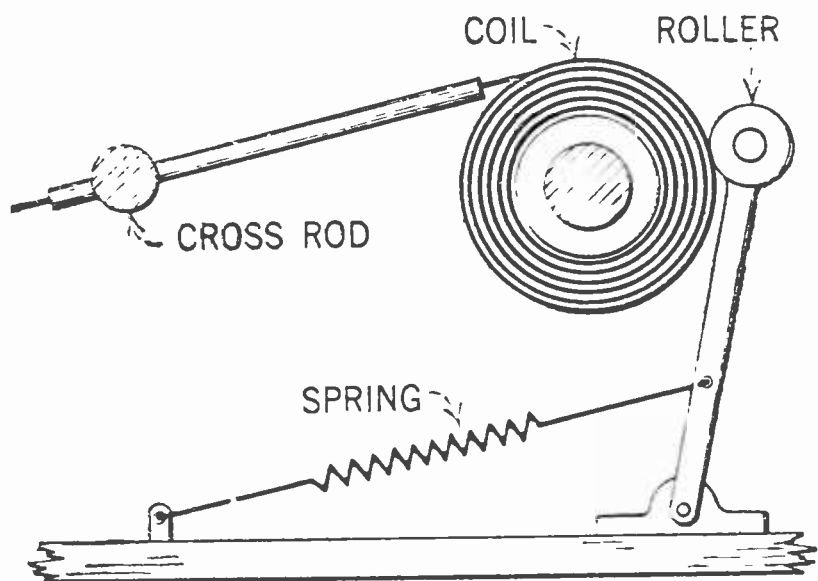

FIG. 8

A detail showing how the roller with spring tension keeps the layers in place

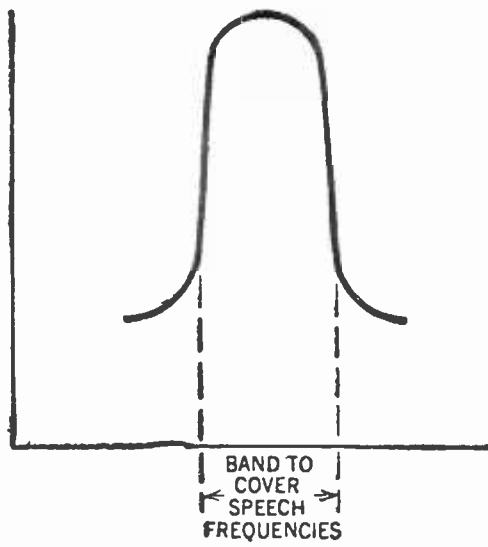

FIG. 9

A curve showing the range of audible frequencies covered by the Hanscom coils

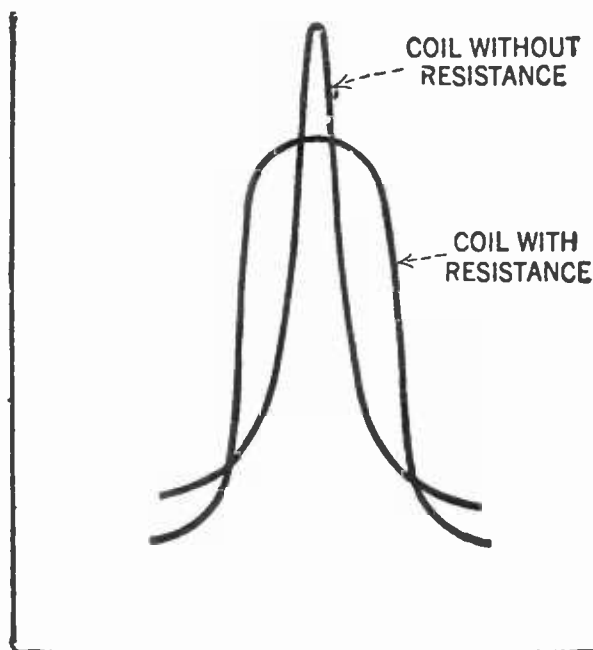

FIG. 10

Illustrates the difference between the Hanscom and other coils, the latter having the tendency to distort by reason of the side bands being chopped off

trols the feed mechanism various effects can be produced, but for average work a $\frac{3}{8}$ of an inch spiral has been found satisfactory. This produces a coil which is $\frac{3}{16}$ of an inch thick. In winding certain kinds of wire it was found advisable to use a roller with a spring tension against the outer edge of the coil as in Fig. 8.

For the intermediate frequency circuit of the super-heterodyne, the writer has used two coils in series, each containing about one thousand turns of No. 36 wire with a .00025 mfd. condenser across the two coils. Various kinds of inductances can be wound on the machine, providing the hole at the end of the nozzle is large enough to permit the wire to run freely through it.

ADVANTAGES OF THESE COILS

THE greatest advantage of these coils is their small size. The magnetic field caused by the coil is naturally small and they

can be mounted without much fear of coupling effect with other parts of the apparatus.

In any form of radio inductance designed for reception of music and speech, it is necessary to cover a band of wavelength sufficient to avoid distortion of the voice or music. This is illustrated in Fig. 9 and in the coils designed by the writer this is obtained by the

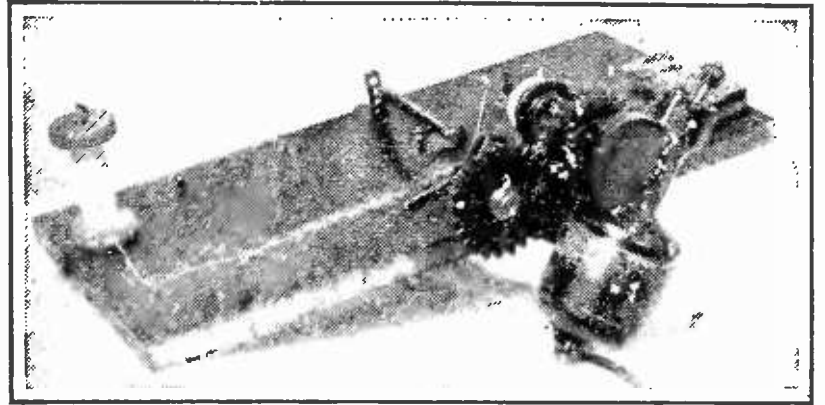

FIG. 11

Shows a rear view of the winder. A worm-drive motor supplies the means for rotation

resistance in the coils which tends to broaden the tuning sufficiently as illustrated in Fig. 10.

To those who are experimentally inclined, the construction of a coil winder as described will be diverting. The writer can assure those who attempt it that they will wind many coils and near coils before the results are entirely satisfactory. This is not said to discourage those who might desire to build it, but rather as a word of warning. Stick to it and it will work!

THE WINDING DATA FOR THE HANSCOM 'SUPER' COILS

INTERMEDIATE-FREQUENCY transformer—Primaries:—In the first stage, the primary coil consists of 500 turns of No. 36

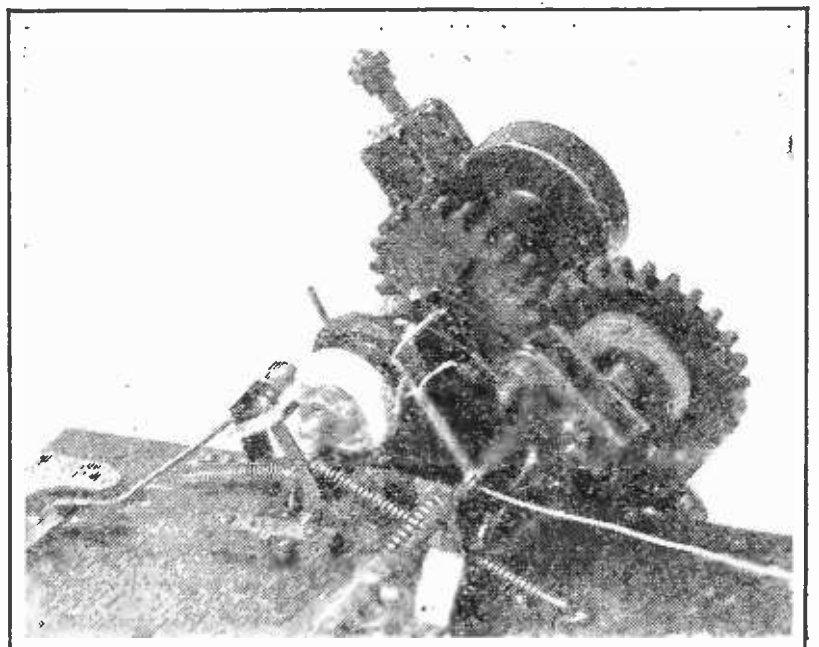

FIG. 12

The nozzle and cam units are clearly shown. An oscillator coil is on the winding bushing

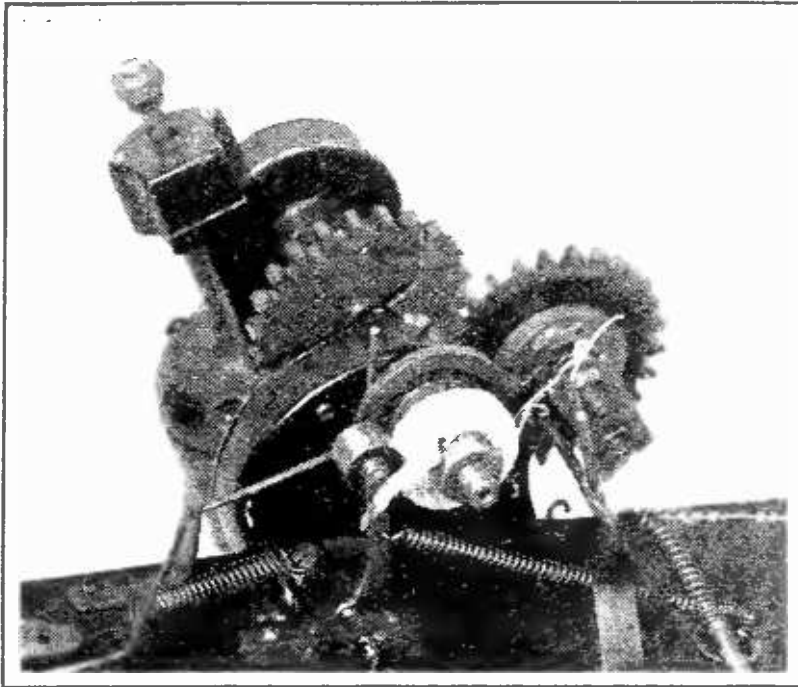

FIG. 13

Another view of the cam and nozzle. Here, also, is shown the method of obtaining tension on the roller bearing, provision for binding and the counter details

s. s. enamel wire. The second stage coil consists of 600 turns of the same wire and the third stage coil consists of 1000 turns of the same size wire.

Secondaries:—Connect two coils in series, each consisting of 1,000 turns of No. 36 s. s. enamel wire for each stage. The first stage coil is tuned by two .0005 mfd., micadons while the second and third stage coils are tuned by a .00025 mfd. micadon, one for each stage.

Oscillator Coils, Grid Circuit:—Two coils are connected in series. The number of turns for these coils depends upon the size of the oscillator tuning condenser and usually varies

between 125 and 160. Double cotton covered wire varying in size from No. 24 to No. 28 may be satisfactorily used.

Plate circuit:—Connect two coils in series, using the same size wire as for the grid coils. As few turns as are necessary to make the tube oscillate uniformly over the entire range of the

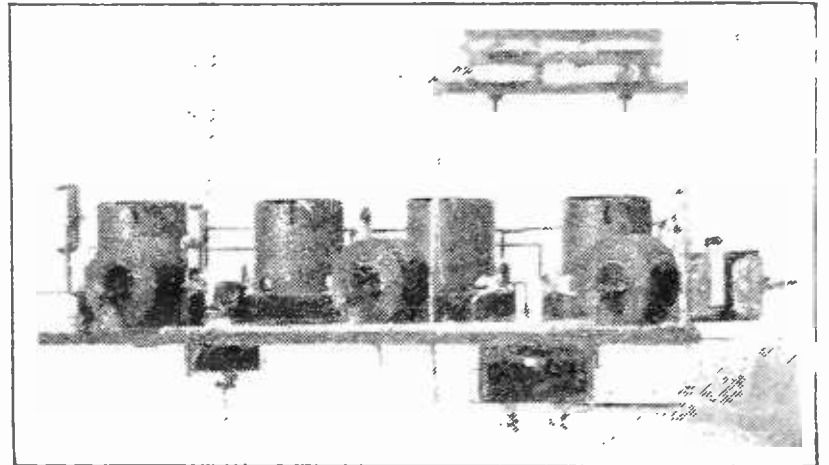
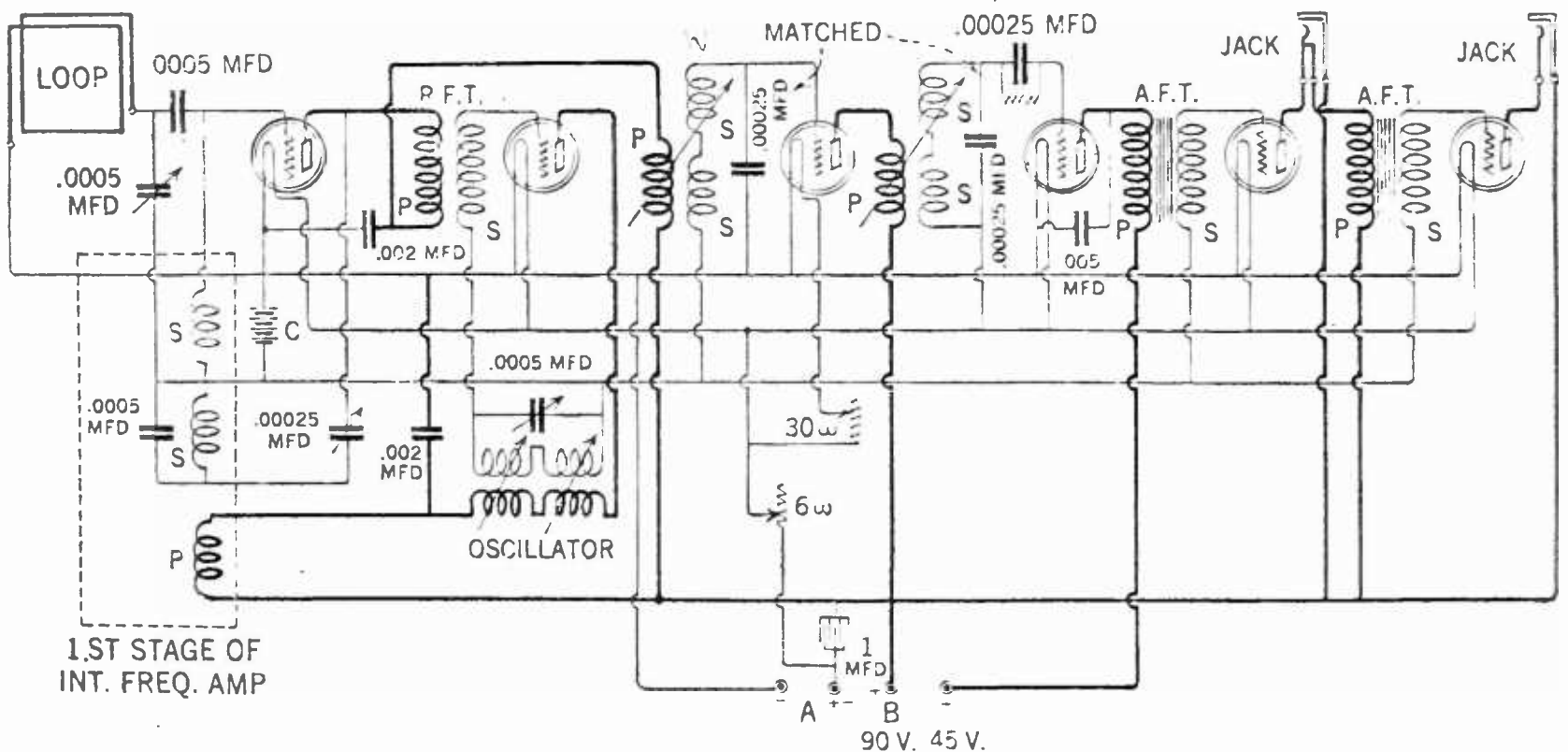

FIG. 14

A completed set of intermediate-frequency amplifier coils mounted in position in an I. F. unit of a second harmonic super-heterodyne receiver

oscillator condenser are used. This number varies between 50 and 75. The inside diameter of the coils is approximately $\frac{5}{8}$ " The overall dimensions of a single coil are $\frac{3}{16}$ " x $1\frac{1}{2}$ ".

It is important that the .00025 mfd. condensers be matched. A small variable neutralizing condenser may be shunted across one of them and varied until the values of both are equal. This may be considered as one of the minor and semi-permanent adjustments of the receiver.



A CORRECTED CIRCUIT DIAGRAM OF THE SECOND HARMONIC "SUPER"

Minor corrections have been made, particularly in that the by-pass condenser on the first audio-frequency primary is connected from the plate to the negative filament lead instead of as shown on page 44 of RADIO BROADCAST for November, 1924

Problems of Receiver Design

How the Super-heterodyne Combines Sound Elements of Design—Theory of Construction of the “Super”

WHAT MAKES THE WHEELS GO 'ROUND: X

BY WALTER VAN B. ROBERTS

IN THIS interesting article, part of Mr. Roberts' series of clear explanatory articles about radio and all its works, the author has not tried to cover the entire field of receiver design, but he has explained some technical points about the super-heterodyne receiver so well that no reader who prides himself on his theoretical knowledge should miss it. This is the tenth article by Mr. Roberts which explains radio theory and practise in his own clear fashion. This first appeared in our magazine for March, 1924.

—THE EDITOR.

IF ALL transmitting stations used the same wavelength (and took turns working) reception would be a much simpler problem. For the receiving set might have as many tuned circuits as the designer had any use for. The owner of the set would not need to change any of the adjustments so there would be no disadvantage, from the operating point of view, in having a very complicated circuit. The idea of the super-heterodyne is simply this: build the very best possible receiving set to work on a fixed frequency (what ever frequency it is easiest to work with), then build a frequency changing device that receives signals on a tuned loop or other antenna and changes their frequency to that for which the receiving set is designed. When tuning-in a station with this combination only two adjustments are necessary: the loop should be tuned to the incoming radio waves, and the frequency changing device should be set to change the frequency to that at which the receiving set is designed to work. Yet in both sensitivity and selectivity this combination has all the advantage given by the large number of tuned circuits and many stages of amplification that can be used in the fixed frequency receiving set.

It is possible that other circuits may be invented in the future that are cheaper or easier to build than a super-heterodyne, but it seems impossible that any could be made to work better because the super-heterodyne can be made ideal from the operating point of view. By taking the trouble to cut condenser plates

very accurately to special shapes, the two condensers that have to be changed in tuning-in different stations could be worked simultaneously by a single knob, which leaves nothing to be imagined in the way of simplicity of tuning.

78. BAND FILTERS

IF THE fixed frequency used is fairly low, the fixed frequency receiver can be made to respond equally well to a band of frequencies sufficiently wide for high quality, and yet not respond at all to frequencies lying only slightly outside of this band. This is ideal selectivity and is achieved by the use of a band filter in the fixed frequency receiver. A band filter

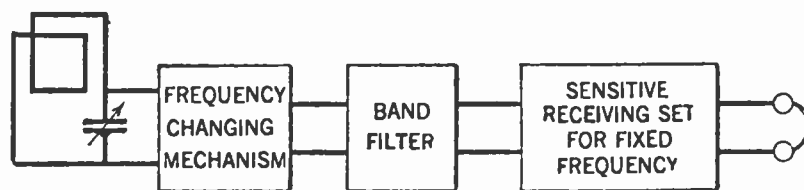

FIG. 65

is a complicated combination of inductances and capacities that allows free passage of frequencies lying inside a given band, but stops all frequencies lying outside that band. Band filters can not be made to select a narrow band from among very high frequencies and so can only be used after the frequency changer has changed the incoming radio signals down to the lower frequency at which the receiver is designed to work. Fig. 65

shows schematically the operation of the super-heterodyne system.

79. HOW THE FREQUENCY-CHANGER WORKS

FIGURE 66 shows a typical frequency changer. Let $e_s \sin st$ be the voltage of signal frequency picked up by the tuned loop. Let $e_h \sin ht$ be the voltage of the heterodyne oscillator's frequency picked up by the small coil coupled loosely to the heterodyne oscillator. The grid potential of the tube is the sum of these two and the C battery voltage, so the plate current will be

$$i_p = K [B + \mu (C + e_s \sin st + e_h \sin ht)]^2 + (\text{small terms that we need not consider here.}) \\ = K [(B + \mu C) + \mu (e_s \sin st + e_h \sin ht)]^2 \\ = K (B + \mu C)^2 \text{ which is direct current} \\ + 2k\mu (B + \mu C) (e_s \sin st + e_h \sin ht) \text{ which} \\ \text{are amplified currents of the signal and} \\ \text{heterodyne frequencies.}$$

$+ k\mu^2 (e_s^2 \sin^2 st + e_h^2 \sin^2 ht)$ which reduces to direct currents and frequencies twice the signal frequency and twice the heterodyne frequency.

$+ 2k\mu^2 e_s \sin st e_h \sin ht$ which is the only term we have any use for, because it splits up into two parts, one of them — $K\mu^2 e_s e_h \cos (s + h) t$ which is the sum of the signal and heterodyne frequencies, and of no interest to us, but the other is $k\mu^2 e_s e_h \cos (s - h) t$ which is the new frequency that we are going to use. The tuned circuit that connects to the fixed frequency receiver picks up only this frequency. It is obvious that this new frequency can be adjusted to any desired value by simply adjusting the frequency of the heterodyne oscillator. For instance, suppose the fixed frequency receiver is built to work at 100,000 cycles and the radio waves are coming in at a frequency of 1,000,000. If we adjust the heterodyne to oscillate at 900,000 cycles the new frequency will be the difference of the two, or 100,000, which is just right to be picked up and received by the fixed frequency set. On the other hand if the heterodyne oscillator is adjusted to 1,100,000 the difference will again be 100,000 so that there are evidently always two possible settings for the heterodyne condenser either of which produces the proper frequency for the fixed or intermediate frequency receiver. Sometimes there is less interference experienced when using one of these settings than the other but usually it makes no difference. From the coefficient of the new frequency term it is evident that its strength depends upon the amount of voltage picked up from the heterodyne oscillator as well as the signal itself. Hence this should be made

large by making the coupling to the heterodyne oscillator sufficiently close. The C battery voltage should be greater than the heterodyne voltage in order to keep the grid at all times negative. The best C and B battery voltages and best coupling can be most simply found by experiment.

80. PROBLEMS OF "SUPER" DESIGN

IN THE actual construction of a super-heterodyne, we are caught between two fires. On the one hand, if we build the fixed, or intermediate-frequency receiver to operate at a fairly high frequency, say one or two hundred kilocycles, we will have difficulty in making it sensitive and selective enough. On the other hand, if we use a very low intermediate frequency, say 30 kilocycles, we are

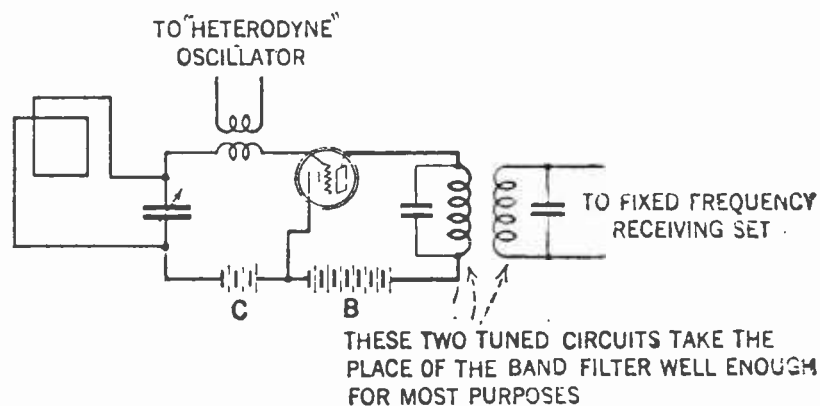

FIG. 66

likely to run into two troubles. The first is that the quality tends to be bad on account of the selectivity being too great, and the other is that unpleasant complications occur in operating the set, due to the signal and heterodyne frequencies being so nearly equal. As the heterodyne condenser is varied there may be a click when the heterodyne frequency passes the value for which the signal circuit is tuned. Also, the same setting of the heterodyne condenser will often bring in two different stations at once whose frequencies are really different by twice the intermediate frequency used, and when the latter is very low, these two frequencies are too close together for the signal circuit or loop to select one to the exclusion of the other.

In view of these considerations three courses seem to be open: (1) to effect the best compromise between the advantages and disadvantages of high and low intermediate-frequency amplification, the choice depending upon what is desired of the set and the location where it is to work, (2) to use the best intermediate frequency for amplification and quality and use a frequency changing device employing special circuits so arranged that only

one station can be received with a given heterodyne condenser setting—and hence conversely only one heterodyne condenser setting will bring in a given station—and (3) to use *two* intermediate frequencies, first a very high one to avoid the complications of tuning that accompany the low “I. F.,” then by means of another heterodyne (this one being fixed once for all) changing down to the best frequency for quality and selectivity and amplification. As there are obvious objections to all three courses, it cannot be said that the goal has yet been reached, although the super-heterodyne *method*, the idea having

the bulk of the receiving set working at fixed frequencies and requiring no tuning adjustments, does not seem capable of improvement.

The chief fundamental methods of reception have been outlined but no attempt will be made to discuss all the circuits in use as nearly all are merely combinations of the methods discussed. For example, regeneration can be combined with the neutrodyne type of amplification by putting a variometer in the plate circuit of the detector tube. Again, the fixed frequency receiver of a super-heterodyne set may make use of neutrodyne amplification and reflexing.

Captain Larkin on Radio

CAPTAIN LARKIN, one of the many heroes in “Mr. and Mrs. Haddock Abroad” by Donald Ogden Stewart, finds himself locked in a watertight compartment of his own vessel while showing some of his portly and pompous passengers about the ship. Several of the passengers suggest means of escape, but the suggestion of the Captain himself is by far the most masterly. He, like the Sheriff of Nottingham in “Robin Hood” has brought his “massive brain and eagle eye” to bear, and his solution of the dilemma is radio. The following diagram and conversation are re-

produced from the book which is copyrighted by George H. Doran and Company, 1924.

“Well,” said the Captain, “my plan rather ingeniously makes use of radio. Have you got a piece of chalk, Mrs. Gerrish?”

“I think so,” said Mrs. Gerrish, feeling in her pockets.

“Here’s one,” said Mrs. Haddock. “Is yellow all right?”

“Yellow will do, I think,” said the Captain, and taking the chalk he drew a rather complicated diagram on the side of the wall, somewhat as follows:

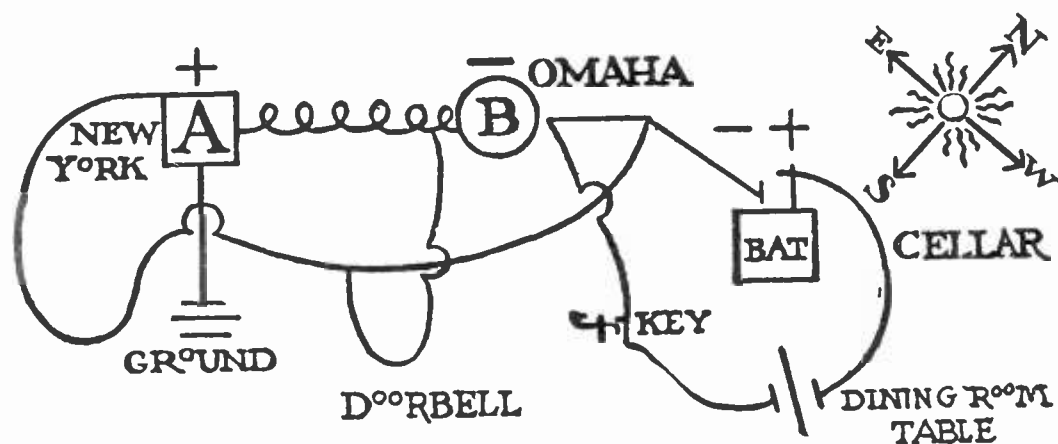

THE RADIO DIAGRAM THAT SOLVED THE PROBLEM
How to escape from a water-tight bulkhead

“Now,” he said, “do you know anything about radio?”

“My son got Pittsburgh one night,” said Mr. Haddock, “but there was a lot of static.”

“What were they playing?” asked Mrs. Gerrish.

“It was some sort of a jazz band,” said Mr. Haddock.

“I like opera best,” said Mrs. Gerrish, and she hummed a few of the more important notes from “Faust.” “That’s from “Rigoletto”.”

HOW TO SELECT A B BATTERY ELIMINATOR

IS THE subject of an interesting article which will appear in an early number of RADIO BROADCAST. There are many points to be considered in purchasing and operating a current-tap device, and this article, written by a radio man of long experience, will be of great value to prospective purchasers.



WHAT OUR Readers Write Us

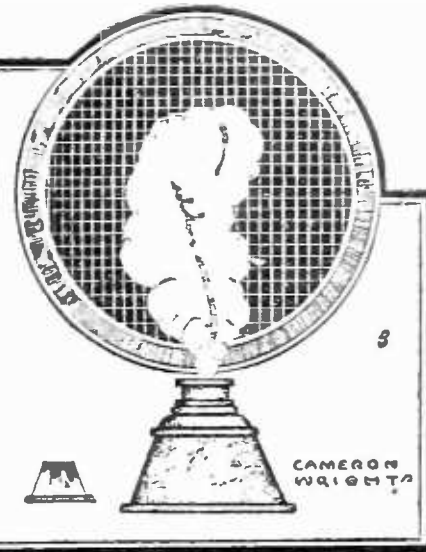

A Word from an Enemy—of the Single Circuit

IT IS growing more and more plain that the enemies of the single-circuit receiver are legion and are increasing in numbers and in intensity of their opposition. As has often been remarked about the unfortunate widespread use of the single circuit set, abolishing it is so largely a matter of militant public opinion that results come a bit slowly. RADIO BROADCAST has in the last two years, lost some "friends" by its constant advocacy of the abolishing of the radiating receiver, chiefly among advertisers, be it said. It is interesting to note that now, very very few single-circuit receivers are marketed by manufacturers who make even faint claims to be reputable.

Editor, RADIO BROADCAST
Doubleday, Page & Company,
Garden City, L. I.

DEAR SIR.

I wish to compliment Mr. Willis K. Wing on his excellent summing up of "The Case Against the Radiating Receiver," but if it is in order, I would suggest a final point with which he might have rounded out his remarks on the single-circuit receiver.

Even if it were not for its severe radiation, the single-circuit set is not even selective enough to merit its consideration as a broadcast receiver. The recent Department of Commerce ruling calling for a compulsory quiet hour from 7 to 10.30 P. M. on the part of amateur stations was necessitated by the fact that at that time the single-circuit was the commonest type of receiver in use. This was not on account of the fact that amateur continuous wave stations actually created interference themselves, but simply because the single-circuit users were not able to tune the near-by stations out, which is, in a sense, unfair to the amateur.

This affliction of broad tuning which also gives the same trouble when the receiver is in a few miles of a broadcasting station, is caused by the fact that when resistance is included in an oscillatory (tuning) circuit, the tuning of that circuit is made broad. In the single-circuit tuner, the coil, condenser, and antenna are all connected together as to form one

circuit, hence the name. Unfortunately, however, antennas have resistance, and most of those built for broadcast reception have comparatively high resistance, so that the antenna being included in the circuit through which the signals enter the detector causes the tuning to become broad. When the tuner is set for a broadcasting station, any other transmitter being operated in the neighborhood on almost any other wavelength will be heard, probably all over the dial.

The remedy for this is to "loose couple" the set; in other words, to bring the antenna and ground leads to a separate coil to be coupled to the grid tuning coil. The honeycomb coil tuner is the outstanding representative of this method of construction, and the so-called three-circuit regenerator as well.

H. S. G., Kitchener, Ontario.

A Radio Samaritan

IT IS most interesting to notice how the gospel is reaching all through the country and how the feeling against the squealing or radiating receiver has taken practical form. People, wherever possible, are getting to do something about this unfortunate situation rather than merely holding forth at great wordy length.

Editor, RADIO BROADCAST
Doubleday, Page & Company,
Garden City, L. I.

DEAR SIR.

Since reading your article "The Case Against the Radiating Receiver" in the October RADIO BROADCAST, I came across this notice in our local paper.

B. N., Gloucester, Massachusetts.

RADIO CONDITIONS IN GLOUCESTER LAST NIGHT

Conditions were good last night. Most stations came through strong. There was very little fading and static.—R. P. M.

WARNING

If the person in the vicinity of Center Street who tunes in morning, noon and night and never gets the station clear without squealing, will please call at my shop, 101 Main St., with his or her radio set. I will make the necessary adjustments and changes in the set free of charge, so that above party will enjoy his radio more, and others in this neighborhood may enjoy theirs also.

R. P. MERCHANT.



WHEN YOU WRITE THE GRID . . .

Don't fail to enclose a stamped, self-addressed envelope with your inquiry if you expect a personal reply.

Don't be impatient if you do not receive an immediate answer. Every letter is answered in the order of its receipt. Do not send a second letter asking about the first.

Look over your files of RADIO BROADCAST before asking a question which might have been covered in a previous issue.

Don't ask for a comparison between manufactured apparatus. The addresses of manufacturers of articles used in the construction of apparatus described in RADIO BROADCAST will be given on request.

Don't include questions on subscription orders or inquiries to other departments of Doubleday, Page & Co. Address a separate inquiry to The Grid.

Don't send us a fee for answering your questions. The Grid Department is maintained for the aid and convenience of readers of RADIO BROADCAST and there is no charge for the service.

QUERIES ANSWERED

WHAT IS THE TROUBLE WITH MY ROBERTS RECEIVER WHEN IT IS POSSIBLE TO RECEIVE WITH THE DETECTOR TUBE REMOVED FROM ITS SOCKET?

C. J. S.—Brooklyn, N. Y.

WILL YOU PRINT A SIX-TUBE CIRCUIT FOR USE WITH A LOOP?

G. H. —Chillicothe, Ohio.

I WOULD LIKE A RADIO-FREQUENCY, REFLEX, AUDIO-FREQUENCY, CRYSTAL DETECTOR CIRCUIT EMPLOYING THREE TUBES.

T. L. G.—Philadelphia, Penna.

MAY I HAVE A DIAGRAM FOR A ONE-CONTROL ONE-TUBE REFLEX CIRCUIT?

L. B.—Austin, Texas.

TESTING THE ROBERTS CIRCUIT

A GLANCE at any of the Roberts Knockout circuits will show us that they are composed of two very important units, namely the neutralized radio-frequency amplifier and the regenerative detector. The audio-frequency amplifier addition is either of the audio-transformer or the resistance-coupled type or a combination of both.

HOW ARE JACKS USED IN RADIO CIRCUITS?

J. P. N.—Savannah, Ga.

I WOULD LIKE A POWER AMPLIFIER CIRCUIT EMPLOYING PUSH-PULL TRANSFORMERS.

E. T. J.—Detroit, Mich.

HOW MAY I PREPARE A CALIBRATION CURVE FOR MY RECEIVER?

C. M. D.—Springfield, Mass.

EXPLAIN HOW I MAY MAKE A CHANGE-OVER SWITCH FOR TESTING RECEIVERS.

A. C. F.—Freeport, L. I. N. Y.

Just now we are interested in the two-tube tuner. Not a few questions similar to C. J. S.'s have been received and we endeavor to clear up the situation with the following explanation.

It is quite evident that the radio-frequency amplifier, in this case, is functioning as a detector unit rectifying the incoming signal without the aid of the regenerative detector. In Fig. 1 is shown a circuit that will aid in putting the entire receiver

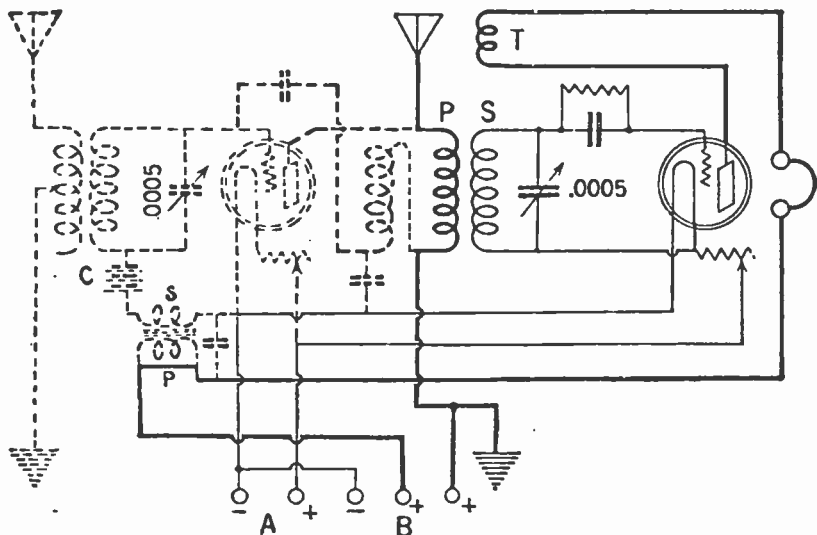

FIG. 1

into proper operating condition. Here, the radio-frequency amplifier with reflexed audio amplifier is eliminated from the main circuit so that the result is a straight three-circuit regenerative receiver. The primary of the audio-frequency transformer is shorted and a pair of phones inserted in series in the plate lead of the detector tube. The first tube is removed from the socket and the antenna and ground are connected to the plate terminal of the first socket and the B90 post, respectively. By bringing the tickler close to the secondary and rotating the variable condenser, a regenerative squeal should be heard in the phones and if the detector responds correctly, carrier waves of transmitting stations will be tuned-in. If this is not the case then the coils should be inspected for reversals of connections, or reversals of windings. The grid leak and condenser may be defective or the tube is not making proper contact with the socket blades. By means of a progressive trouble-elimination system it is possible finally to make the necessary corrections so that the first tube in the radio-frequency amplifier circuit may again be thrown in and the operation observed. Other trouble-shooting suggestions were contained in the January, 1925, GRID.

A SIX-TUBE LOOP SET

FOR those who want a multi-tube radio frequency amplifier-detector-audio-frequency amplifier circuit with preferably one tuning control, the circuit shown in Fig. 2 is suggested. A receiver employing such a circuit may be easily con-

structed as a portable set, having the batteries contained in the cabinet as a part of the receiver. A loop consisting of about 12 turns of No. 18 d.c.c. wire wound on a 2 ft. square frame, shunted by a .0005 mfd. condenser will effectively cover the broadcast range of wavelengths. The use of an antenna and coupler is inadvisable as the chances for radiation are too great. The radio-frequency transformers to be used in this circuit are of the untuned type having an average wavelength range of 200 to 550 meters. If it is desired, the tuned type of transformer with a variable condenser shunting each secondary may be employed, but the tuning becomes increasingly difficult for each stage used. The potentiometer allows the circuit to be adjusted to its most efficient point of operation and also controls to a large degree the tendency of the receiver to oscillate. As a further oscillation control it may be necessary to connect the return lead of the grid circuits of the second and third tubes to the potentiometer arm.

A THREE-TUBE R. F.-A. F. REFLEX RECEIVER

M R. T. L. G. asks for a circuit consisting of two stages of radio-frequency amplification, crystal detector, one stage of reflexed audio-frequency amplification through the second stage of radio and a stage of straight audio. This circuit appears in Fig. 3. One rheostat of ten ohms is sufficient for controlling all three tubes. The radio-frequency transformers used are standard neutroformers, the secondaries of which are shunted by .00037 mfd. condensers. The audio reflex transformer should be of a low ratio as should the stage of straight audio. A C-battery is inserted in the reflex stage and the last audio stage for stabilization purposes. Two jacks situated in the circuit as shown allow the use of two or three tubes. In this circuit it is absolutely essential that a good crystal be used for satisfactory results. UV-201-A's are used throughout.

A ONE-CONTROL, ONE-TUBE REFLEX RECEIVER

FIGURE 4 shows a revamped one-tube crystal reflex receiver having one control. The coupler T1 may be the standard variocoupler obtainable on the market or it may be of the type employed in the RADIO BROADCAST one-tube Knockout receiver

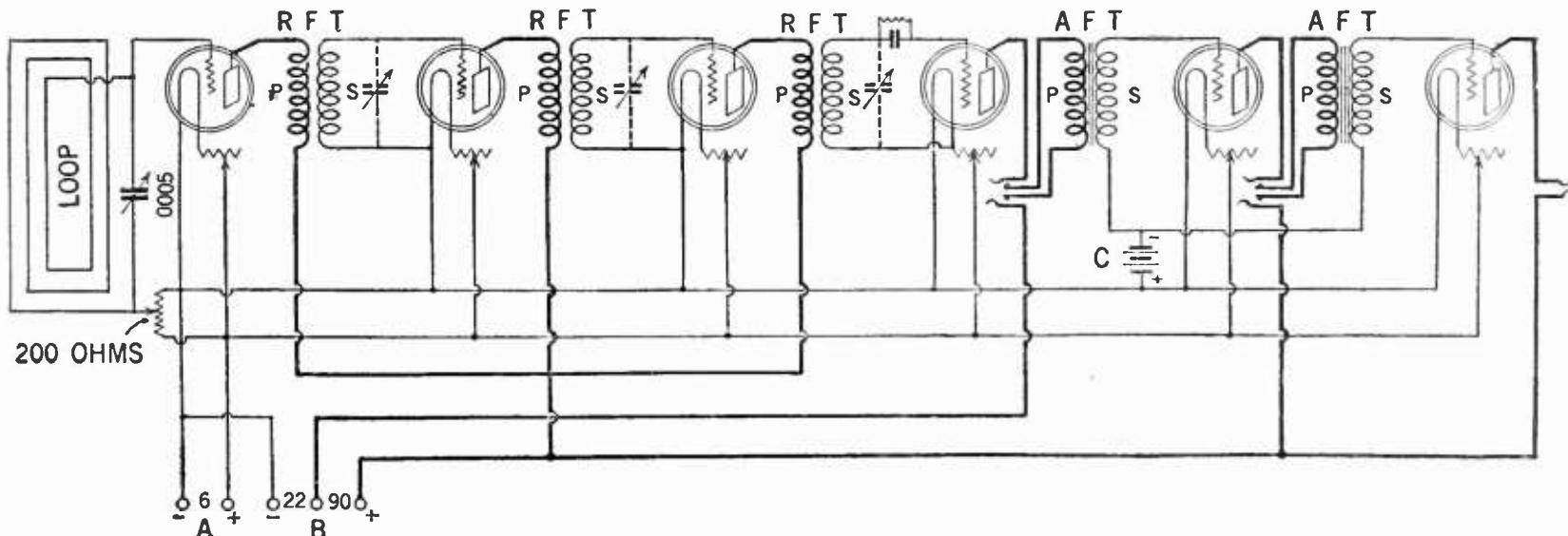

FIG. 2

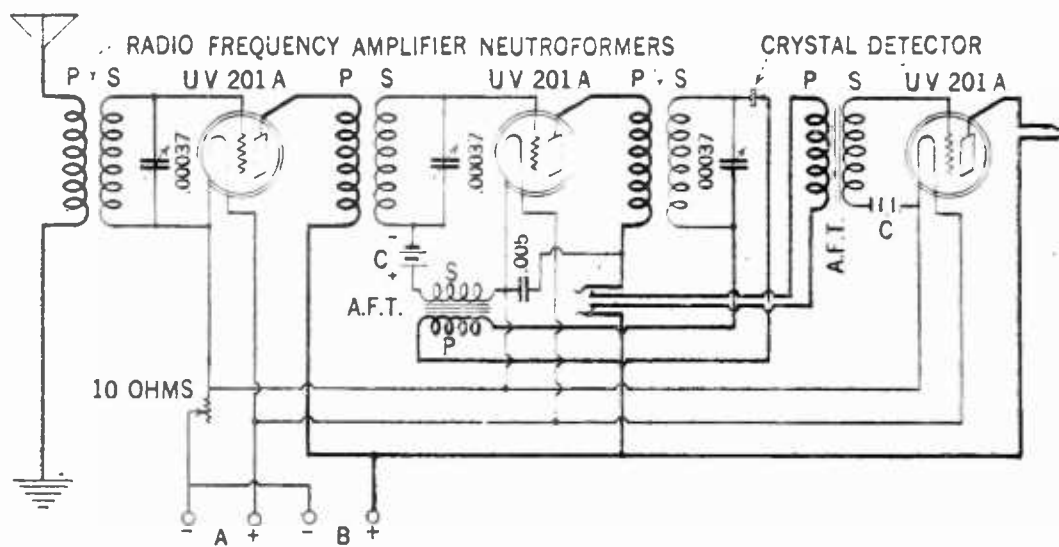

FIG. 3

as explained in the April, 1924, RADIO BROADCAST. The radio-frequency transformer T₂ is of the untuned type and covers a wavelength range of 200 to 550 meters. Much of the instruction as outlined for the three-tube circuit of Fig. 3 may be followed in the construction of this receiver. Especial care should be exercised in the selection of a suitable audio-frequency transformer and crystal.

JACKS, AND HOW THEY ARE USED

THERE are as many types of closed circuit jacks as there are manufacturers of them. It should be remembered that jacks are used for the sole purpose of providing a mechanical cut-in on any part of a radio circuit. In the natural progress of things, jacks came to be used in more elaborate ways. One manufacturer produces 14 different kinds of jacks. Not all of them can be explained here but several of the more well-known type are illustrated in Fig. 5, A and B. In A, the several styles are outlined and their use is depicted in B. For the output jack in the stage of an amplifier or a plain detector circuit we have that as shown in 1. This is called the single open-circuit type. In 2 is shown a single-closed circuit type permitting the throwing in or out, automatically, of the primary of a transformer. Another method of performing the same operation is shown in 3. That shown in 4 is fundamentally the same as that shown in 1 except that a filament control is included which breaks the filament circuit when the plug is withdrawn from the jack.

In 5 we have practically the same as that shown in 2 with the addition of the filament control as explained. The method of controlling one or more filament circuits by means of jacks is shown in 6.

A PUSH-PULL POWER AMPLIFIER

IN THE construction of a push-pull amplifier, the selection of satisfactory parts plays an important role. In fact, the ultimate successful operation of the unit depends upon this consideration more than anything else. The input stage audio transformer should have a low ratio, say 2 to 1, so that the voice and music is not unnecessarily distorted before it reaches the push-pull transformers. The action and theory of operation have already been explained in past issues of RADIO BROADCAST

and will not be repeated here. The suggested circuit is shown in Fig. 6. Any standard type of tubes may be used in a unit of this kind but of course UV-201-A's or better still, power tubes such as the 202 or the W. E. 216-A will be more suitable for this type of work. The value of C battery will vary in proportion to the amount of B battery used. A table of C battery voltages was included in THE GRID for January, 1925. For the tubes suggested 120 to 150 volts B battery will be sufficient.

CALIBRATION CURVES

ALMOST any type of receiver may be charted and calibrated so that a graphical curve is produced that may be used for reference purposes. Instead of rumaging through numerous papers having dial settings numerically listed, it is much easier and more efficient to refer to the ship-shape wavelength curve that also helps you to locate new station positions on your tuning dial. Neutrodyne and tuned radio-frequency receivers, superhetrodynes, and crystal reflex receivers furnish the most accurate curves. In the regenerative type of receiver, several combinations of inductance and capacity will tune to the same station and the curve system of tuning is not so dependable or reliable. A specimen of a wavelength graph curve is shown in Fig. 8. The several points marked on the diagonal line indicate station positions. For instance 492 meters, WEA F, is located on the vertical border to the left; running across horizontally on the 492 line we note where it is intersected by the diagonal line. Then, coming down vertically, it is found that this position is equal to 81 on a 100 segment semi-circle of the dial. This base line is comparative to and indicates the markings on the dial. To prepare a wavelength curve it is well to have commercial graph paper that is obtainable in most stationery shops. The dial markings are laid off at regular, equal intervals along the base line and the wavelength range, usually from 200 to 600 meters is laid off in a

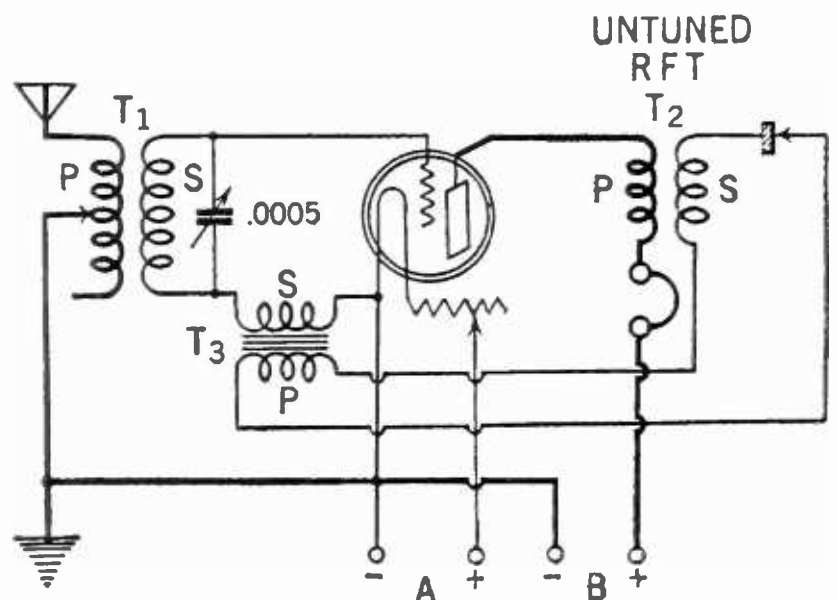

FIG. 4

MAGNAVOX Radio

Receiving Set TRF-5 with
Reproducer M4 - \$125.00



EXPERIENCED radio users have stated that this Magnavox equipment (illustrated below) represents the highest standard of real value and usefulness ever offered in the radio field.

The Magnavox 5-tube circuit is a special development of tuned radio frequency in which a splendid balance of selectivity, range and volume have been attained. The one dial Station Selector eliminates all tuning adjustments; while the Magnavox Reproducer insures sonorous, pleasing tone for all programs.



Magnavox Radio Receiving Sets, Tubes and Reproducers are carried by reliable dealers. Illustrated booklet on request.

THE MAGNAVOX COMPANY

OAKLAND, CALIFORNIA

New York:
350 West 31st St.

Chicago:
162 N. State Street

San Francisco:
274 Brannan St.

Canadian Distributors: Perkins Electric Limited, Toronto, Montreal, Winnipeg

2R



★ Tested and approved by RADIO BROADCAST ★

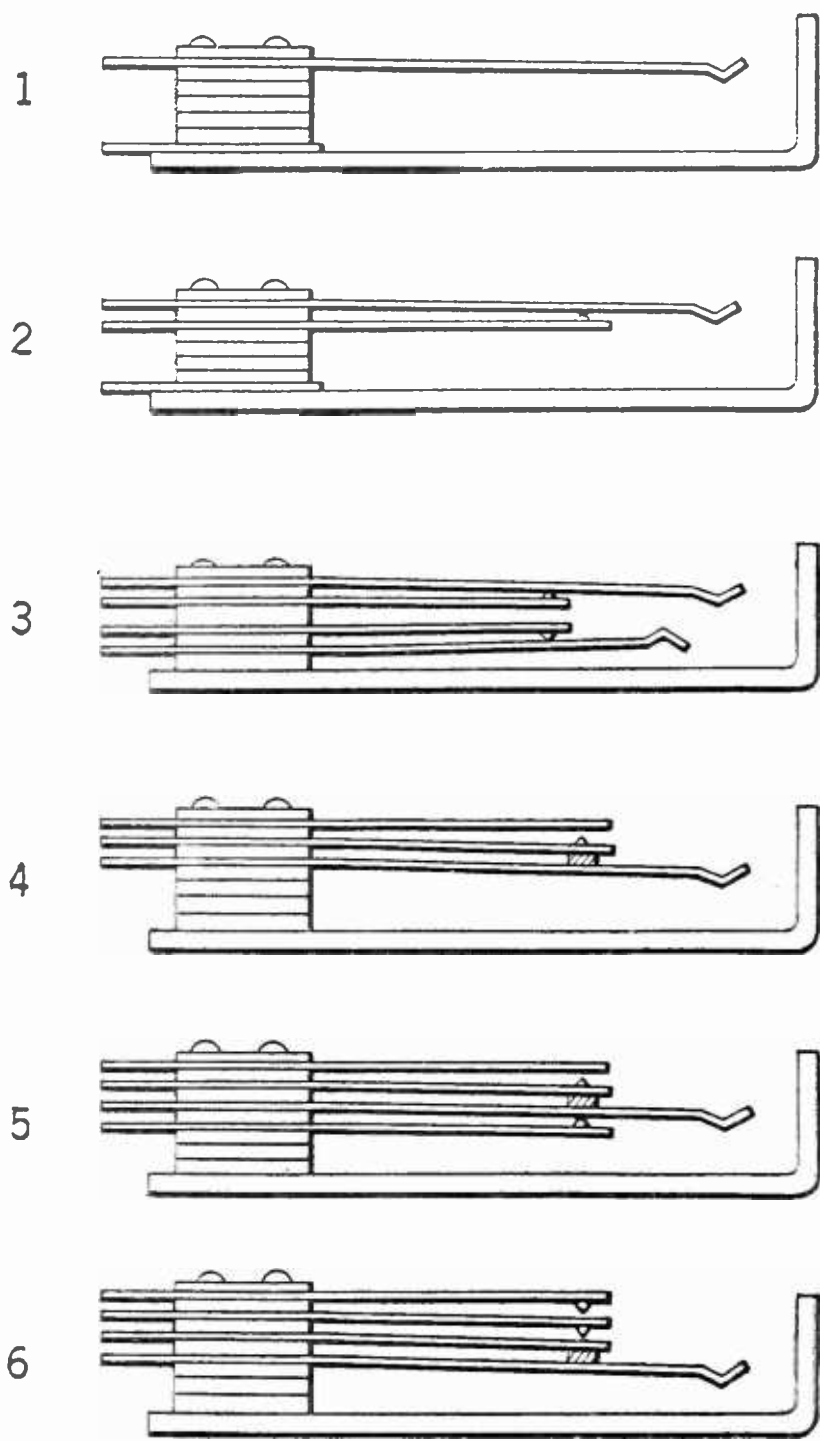

FIG. 5A

like manner on the vertical left border line or vice versa. Beginning at the lower wavelengths, the dial position for the stations tuned-in on the receiver are located by cross-reference continuing until the maximum setting has been obtained. A line is then drawn from point to point resulting in a continuous curve. Not all curves will be very straight as the settings at the lower wavelengths are crowded closer together than at the higher settings. The curve shown in Fig. 8 is an exaggerated example to serve as an illustration. A more correct form is shown in Fig. 7.

BATTERY SWITCHES FOR TESTING SETS

IN MAKING comparison tests between radio sets, it is advantageous to have a double throw switch by which either of two sets may be quickly connected to the antenna and ground and to the batteries. The arrangement of a switch to do this is complicated by the fact that various manufacturers use different methods of connection between the A, B, and C batteries.

Considering only two plate voltages and one bias voltage, a nine-pole double throw switch would seem to be required in order to prevent short circuit of the

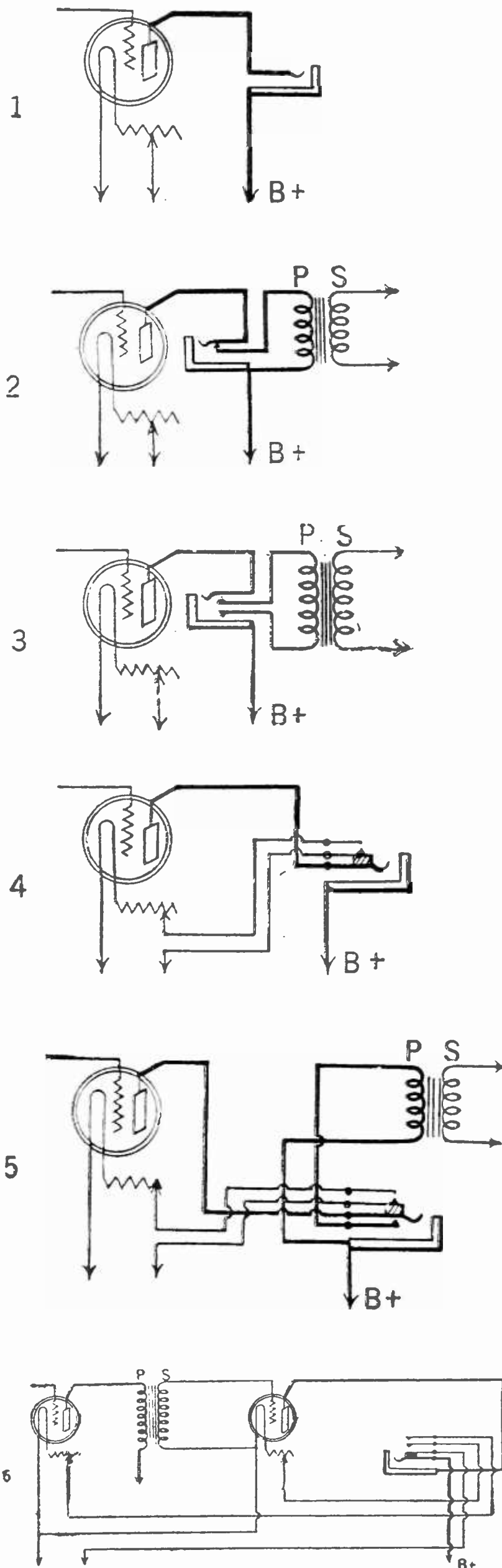
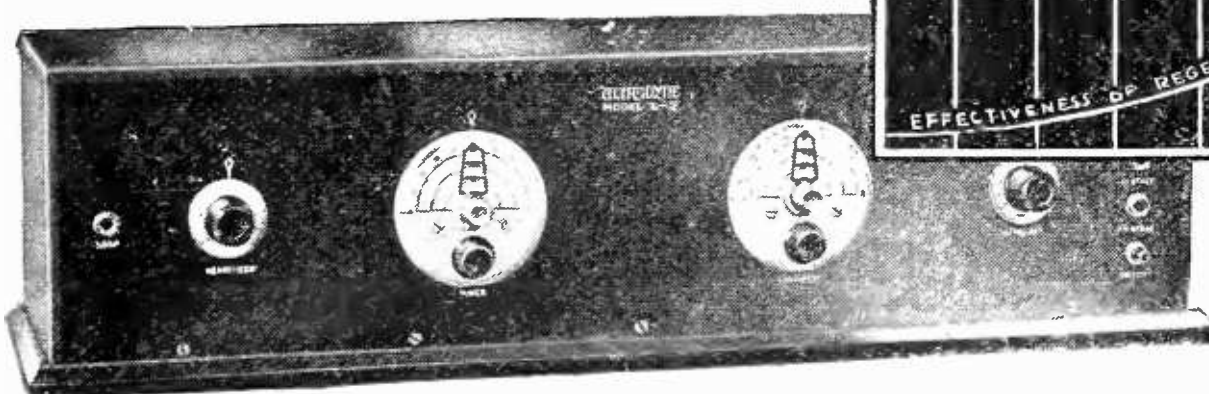
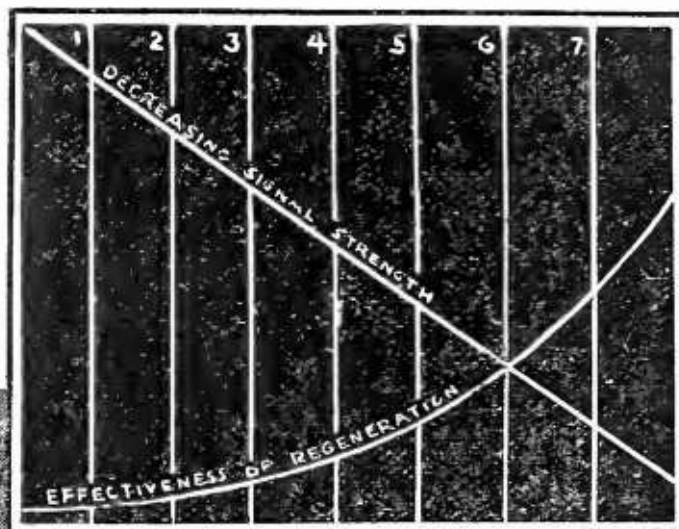

FIG. 5B

Graph showing how the regenerative effect in the Model L-2 Ultradyne increases as the strength of the recede decreases



Why the ULTRADYNE Gets Distance on the Loud Speaker!

The ULTRADYNE Kit

consists of 1 Low Loss Tuning Coil, 1 special Low Loss Coupler, 1 type "A" Ultraformer, 3 type "B" Ultraformers, 4 matched fixed Condensers.

To protect the public, Mr. Lacault's personal monogram seal (R.E.L.) is placed on all genuine Ultraformers.

\$30.00

UNLIKE other Super-radio receivers, the Ultradyne, with its exclusive use of the "Modulation System" and special application of regeneration, is capable of detecting and regenerating the faintest signal, making it audible on the loud speaker.

The regenerative effect in the Ultradyne increases as the strength of the signal decreases, until the signal becomes so weak that no amount of amplification will make it audible.

A radical advance in radio engineering and the latest development of R. E. Lacault, E.E., A.M.I.R.E., Chief Engineer of this Company and formerly Radio Research Engineer with the French Signal Corps Research Laboratories.

You will marvel at the unusual selectivity, sensitivity and range of this new Model L-2 Ultradyne.

How to Build and Operate the ULTRADYNE

32-page illustrated book giving the latest authentic information on drilling, wiring, assembling, and tuning the Model L-2 Ultradyne Receiver.

50c



Write for descriptive circular

ULTRADYNE

MODEL L-2

Phenix Radio Corporation

5-7 Beekman Street
New York City



★ Tested and approved by RADIO BROADCAST ★

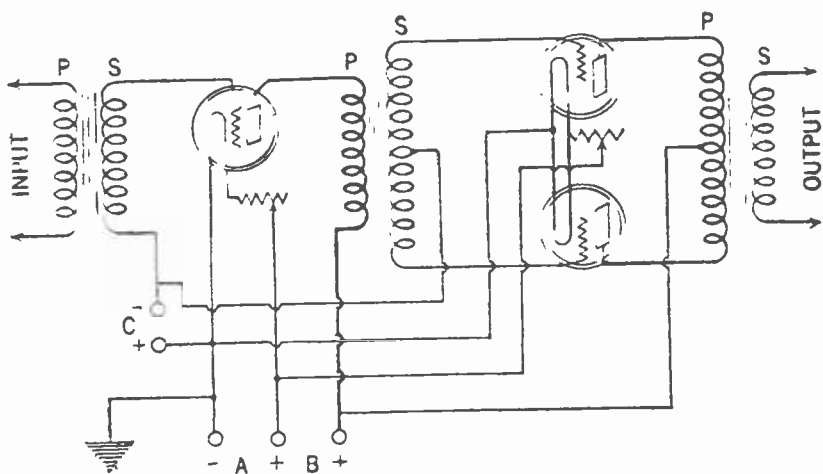

FIG. 6

batteries due to differences in inter-connection in the sets. These nine points would be:

Antenna 90 45 -B +A -A +C -C Ground

An investigation shows that a six-pole switch can be made to do the work, because the 90 volt, the 45 volt, and the -C are all insulated in any receiver. These three points can therefore be omitted

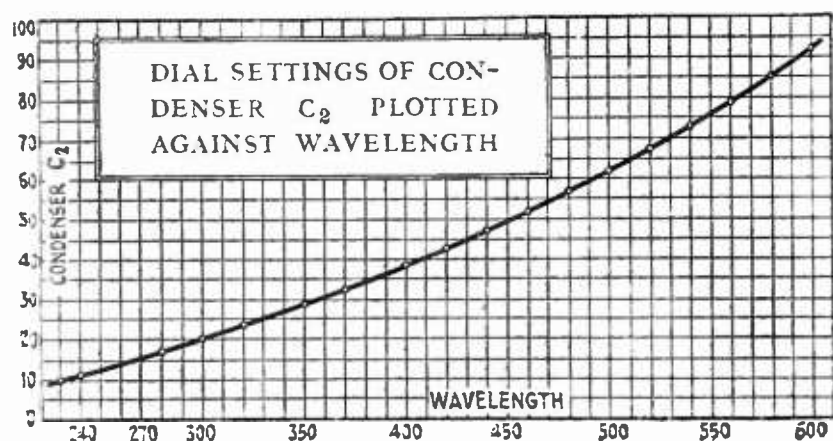

FIG. 7

from the switch and terminals can be provided for them to which all the sets may be permanently connected as indicated on the instruction card. The switch will then carry:

Antenna -B +A -A +C Ground

This arrangement has the further decided advantage that terminals can be provided for various B and C battery voltages and the sets under test can be connected directly to these terminals. For example, terminals can be provided for 22, 45, 90 and 135 volts B battery and for 4½ and 9 volts C battery. Inasmuch as opening the switch disconnects the -B and the +C, and disconnects the A battery entirely, from all sets, there is no possibility of a short circuit, due to differences in inter-connections.

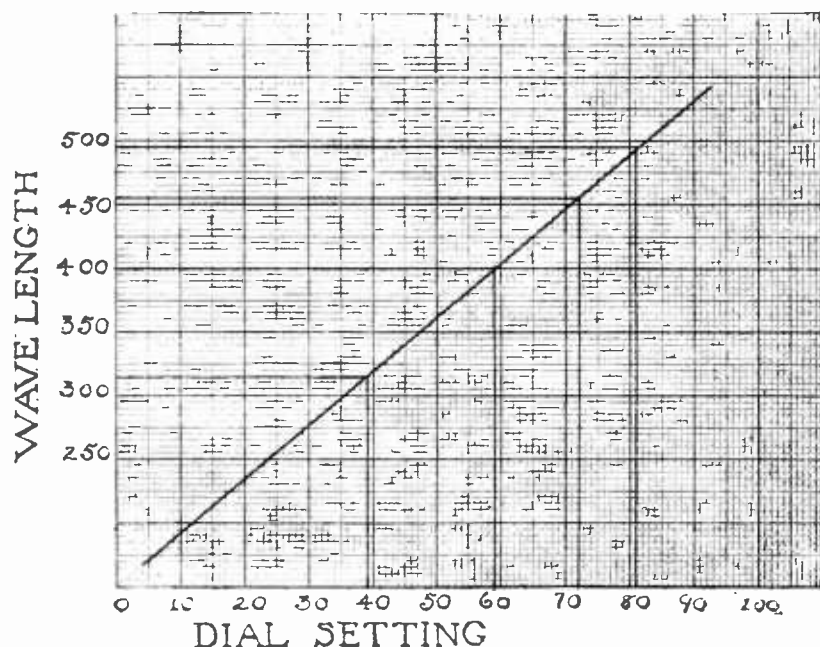

FIG. 8

EXCLUSIVELY IN RADIO BROADCAST

MUCH interest has recently been aroused by the announcement that photographs have been successfully transmitted across the Atlantic, and from point to point in this country by radio. As everyone realizes, the successful transmission of photographs means that one could send practically as well complete printed pages. Signatures to valuable documents could be exchanged, as could photographs of the documents, at great distances. The other possible applications of this new branch of radio are pretty well known. RADIO BROADCAST has arranged to print a series of articles describing a method of radio transmission which has never yet been published. Experiments have been in progress for more than two years, along lines totally different from those of the Jenkins system and the Ranger system, of the Radio Corporation. These articles will contain some very startling revelations from the point of view of radio photograph transmission. There is no announcement we have made in many months which should so interest the reader who prides himself on following the latest developments in the field.



*Dry "B" Batteries
are an economical,
dependable and
convenient source
of plate
current!*

No. 770. 45-volt
extra large ver-
tical. For heavy
duty only. The
ideal "B" Bat-
tery for use on
multi-tube sets.
Price \$4.75.



Scientists constantly improve battery quality

EVEREADY "B" Batteries today contain more electricity, more service, more satisfaction than ever before.

Processes evolved by the scientists of the Union Carbide and Carbon Research Laboratories, Inc., when put in effect in the Eveready factories, are responsible for this great accomplishment.

At the same time the factories have effected a still higher standard of workmanship. A system of inspection that is a marvel of efficiency was inaugurated. The results, gratifying beyond measure, were accomplished with a speed and completeness that have few

parallels in industry. The final tests showed more electricity, more battery service, greater Eveready satisfaction without increasing battery sizes *and with a substantial reduction in price.* "B" Battery operating costs, using the new Evereadys, in most cases show a reduction of at least one-half.

There is an Eveready Radio Battery for every radio use.

Insist on Eveready "B" Batteries.

Manufactured and guaranteed by
NATIONAL CARBON COMPANY, INC.
Headquarters for Radio Battery Information
New York San Francisco
Canadian National Carbon Co., Limited, Toronto, Ontario

EVEREADY Radio Batteries

- they last longer

EVEREADY HOUR
EVERY TUESDAY at 9 P. M.
(Eastern Standard Time)
For real radio enjoyment, tune
in the "Eveready Group." Broad-
cast through
WEAF New York WJAR Providence
WEEI Boston WFI Phila.
WGR Buffalo WCAE Pittsburgh

★ Tested and approved by RADIO BROADCAST ★

New Equipment

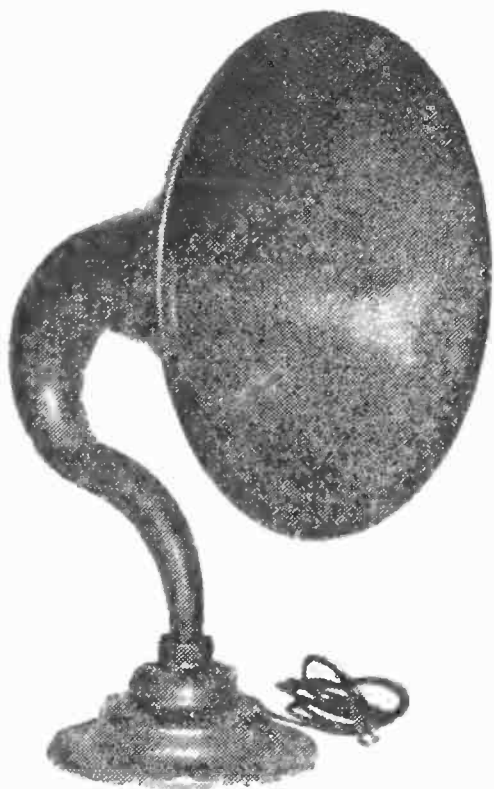

DE FOREST LOUD SPEAKER

A reproducer of good design and quality which compares very favorably with other speakers of the same price range. It delivers good volume on both speech and music, still maintaining good tone quality. Made by the De Forest Radio Company, Jersey City, New Jersey. Price \$25



ANTENNAPHONE

A very neat indoor aerial. It is only necessary to place your house telephone upon the antennaphone plate and connect the lead to the antenna binding post of your receiver. Made by The Antennaphone Co., 90 West Street, New York City. Price \$1.00



NATIONAL BATTERY

This is a 24-volt unit wet B battery of good construction. The connectors between the several cells protrude above the sealing so that it is possible to tap off at any desired voltage. Made by the National Lead Battery Company, 1704 Roblyn Ave., St. Paul, Minn.

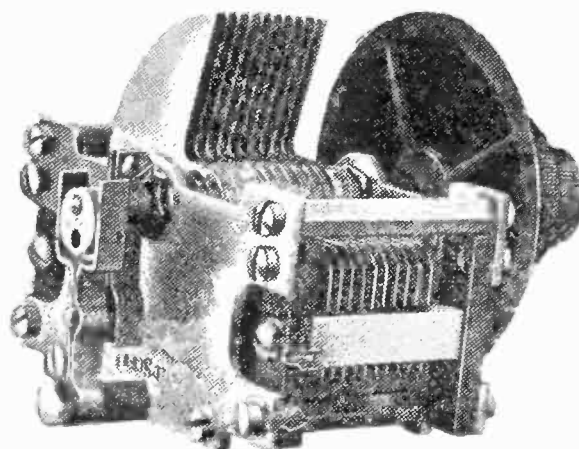

U. S. L. CONDENSER

A well made instrument which has a good capacity range. The vernier action, which shows at the back of the condenser, is controlled by the small knob acting through the center of the main dial. Made by The United Scientific Laboratories, Inc., 92 East 10th Street, New York City

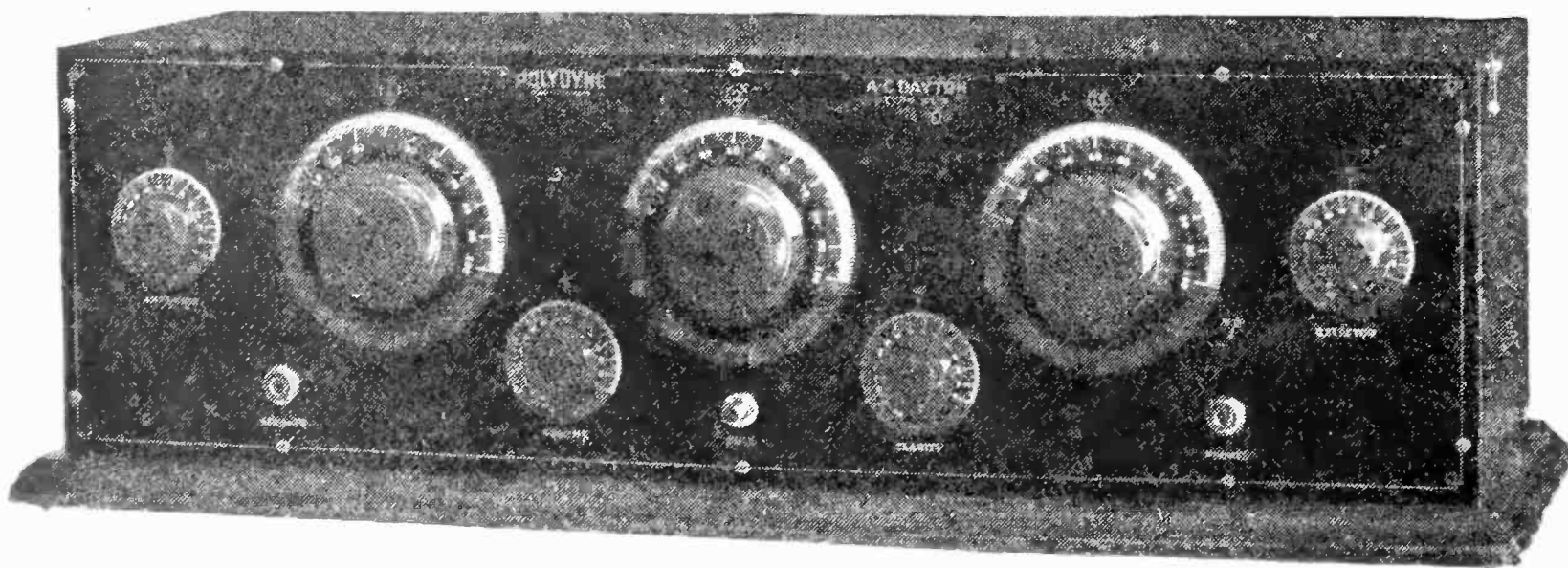

THE A-C DAYTON XL-5

A five-tube set using tuned radio-frequency, detector and audio-frequency amplification. The radio-frequency transformers are of special design. Very satisfactory performance is possible with this receiver. Made by The A-C Electrical Mfg. Co., Dayton, Ohio. Price \$115

PERFECTO SOLDERING FLUID—A convenient and satisfactory, non-acid soldering flux that insures positive soldered joints. John Firth & Co., 25 Beaver St., New York City

FADA Radio



**FADA Neutroceiver
No. 175-A**

Mahogany cabinet. Inclined panel and roomy battery shelf. 5 tubes. Price (less tubes, batteries, etc.) \$160.

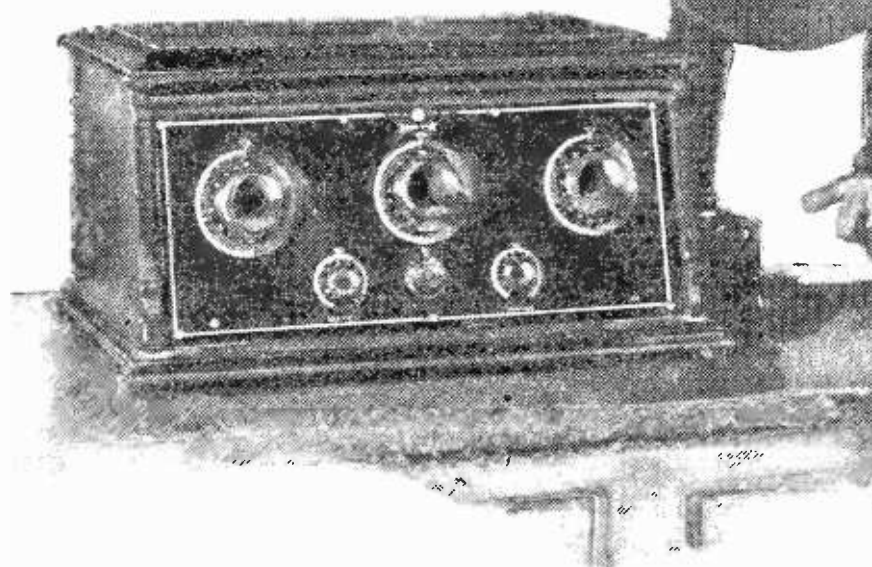

Indecision vanishes when you hear the FADA

RADIO shopping ends triumphantly when you find the FADA. People who know radio and have conducted comparative tests say that the Neutroceiver is the best they have ever tried. Have the FADA Neutroceiver demonstrated in your home. Listen to its marvelously faithful reproduction. Tune in a distant station yourself loud and clear and see how easy it is. Observe the beautiful cabinet design. You will

exclaim: "At last! This is just the radio set I want!"

If you prefer a set with self-contained loud speaker, the FADA Neutrola Grand meets your desire in this respect, as in all others. Whether FADA Neutrodyne receivers are the first or the fifteenth make you investigate, they will be your final choice. Through the FADA Neutrodyne your radio wishes become realities. See your dealer.

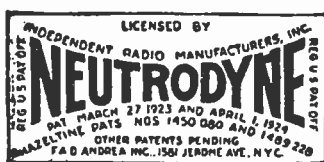

E. A. D. ANDREA, INC., 1581 JEROME AVENUE, NEW YORK

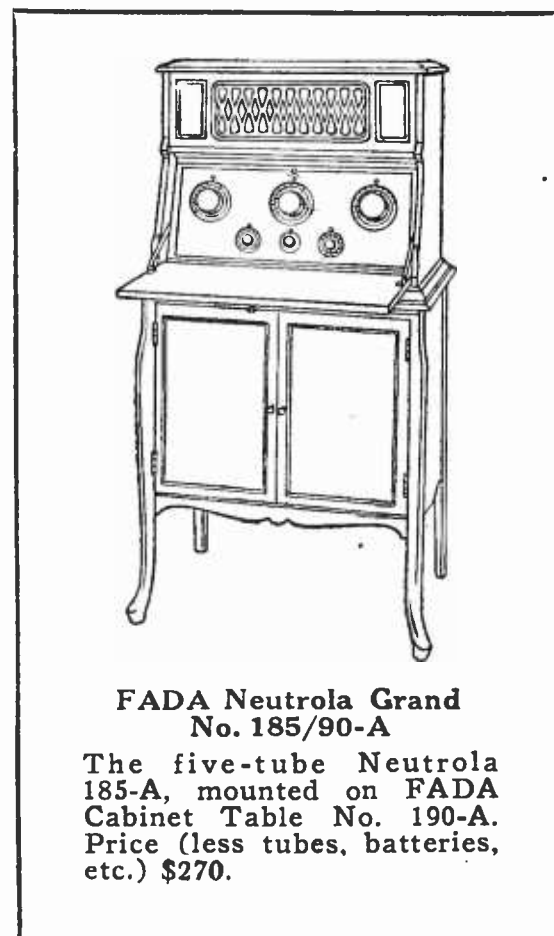

**FADA Neutrola Grand
No. 185/90-A**

The five-tube Neutrola 185-A, mounted on FADA Cabinet Table No. 190-A. Price (less tubes, batteries, etc.) \$270.

★ Tested and approved by RADIO BROADCAST ★

Among Our Authors

THE cover of this month's RADIO BROADCAST was done by Remington Schuyler, who is a well-known painter of outdoor scenes. Mr. Schuyler is regarded especially highly for his authentic canvasses of Indians. The February cover, with the R-B Lab as its subject, was "done from life." The masts and radio cabin are faithfully portrayed, but the bulk of the Doubleday, Page & Company buildings, some five hundred yards away, have been omitted from the painting.

MYRA MAY writes: "For the last ten years I have been trying to understand just what makes an automobile run. Just as I was reaching a point where I understood the difference between a clutch and a snubber, along comes radio, with its confusion of grids, antennae, and heterodynes. Up to date, I have learned that if you use your fingers for a plug, you move your hand away quickly. That lesson so well learned, I haven't the heart to go further into the subject."

WILLIAM P. GREEN, whose second article on "The Way of the Transgressor" appears this month, has done some very effective work in keeping the advertising and sale of radio goods in the path of the righteous. His headquarters are in New York.

JULIAN KAY, an old-time radio worker, has just finished his requirements for a doctor's degree in physics at Harvard University. We expect soon to print more of his eminently readable and interesting radio articles.



DUDLEY SIDDALL

Mr. Siddall discovered New York in 1919 and found that Wall Street celebrates more business holidays than any other place in the United

States. His greatest achievement, he says, was to spend fifteen years in newspaper work without once being a copy-reader. He is now in the advertising business and enjoys breaking the news to newspaper men that "I used to be a newspaper man myself."

WHEN the Union Trust Company, in Cleveland, decided to establish a broadcasting station, Don S. Knowlton from the bank's advertising department was drafted to arrange the musical programs and was later put in charge of the station.



D. S. KNOWLTON

ZEH BOUCK had the even tenor of his way greatly broken up the other day when he observed in the *Radio Service Bulletin* of the Department of Commerce, that Senatore Marconi had been granted an English patent on "bean transmission." Mr. Bouck is wondering just why the noted Italian has forsaken applied physics for applied cookery.

JOHN C. DAVIDSON is a commercial radio engineer whose experience in the field dates back to very early days. Since broadcasting came into popularity, he has been devoting his talents to the design of radio parts, some of which, especially a fixed crystal detector, are widely used.

ALLAN T. HANSCOM is a resident of Woonsocket, Rhode Island, and a graduate of the engineering school of the University of Pennsylvania. His article in the November RADIO BROADCAST on a second-harmonic super-heterodyne has attracted wide attention among that great group of radio enthusiasts who are intensely interested in anything to do with that highly efficient receiver.

CAPTAIN P. P. ECKERSLEY is the man responsible to the British radio public for their radio programs, being chief engineer of the British Broadcasting Company. Much of the material in his article was presented to the recent Radio Conference in Washington, called by Secretary of Commerce Herbert Hoover.

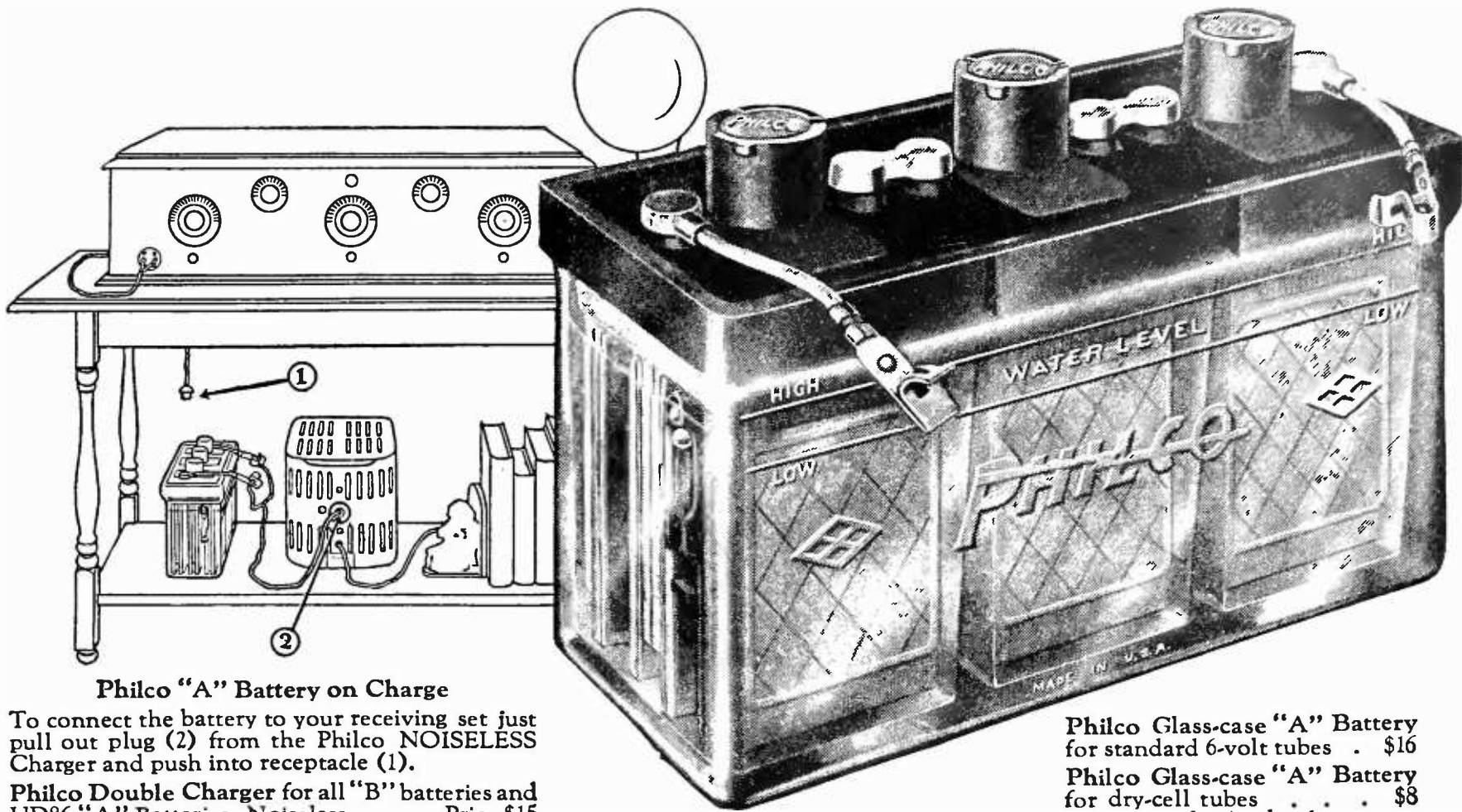

Philco "A" Battery on Charge

To connect the battery to your receiving set just pull out plug (2) from the Philco NOISELESS Charger and push into receptacle (1).

Philco Double Charger for all "B" batteries and UD86 "A" Batteries. Noiseless . . . Price \$15

Philco Single Charger for all "B" batteries and UD44 "A" Batteries. Noiseless. . . Price \$9.75
Charger Prices include plugs and receptacles.

Philco Glass-case "A" Battery for standard 6-volt tubes . . \$16
Philco Glass-case "A" Battery for dry-cell tubes . . . \$8
Spray-proof. Acid-tight.

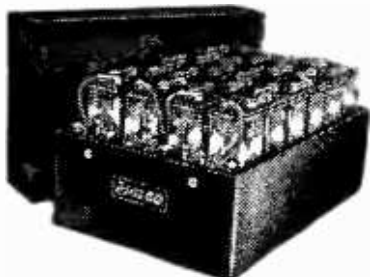

Philco "B" Battery

Philco "B" Batteries stay clean and dry. Charge without disconnecting a single wire. Use a Philco charger and "B" Charging Panel (\$2.75)

With de luxe mahogany-finish case with cover (48 volts) \$20

With handsome mahoganzed case without cover (48 volts) . . . \$16.50



Philco Mahoganzed-Case "A" Batteries

Two types—RAR and RW— for 6-volt tubes. Both in beautiful Adam-brown mahogany-finish cases harmonizing with your radio cabinet.

Price \$14.50 up

Philco Charge Tester—permanently mounted in filler cap, avoids fussing with hydrometer, \$1 extra.

Just a plug in a socket and your Philco is on charge!

Recharging a Philco Radio Battery with a Philco NOISELESS Charger means merely pulling a plug from your radio socket and pushing it into the charger socket. See sketch above.

No changing wires. No moving the battery. No worry about burning out tubes by getting positive and negative wires mixed.

Philco Radio Batteries—both "A" and "B"—have other big advantages that make storage battery operation easy, convenient and economical.

They are assembled in attractive acid-tight, spill-proof glass cases—or in wood cases finished in beautiful Adam-brown mahogany. They have exclusive built-in Charge Indicators that tell you at a glance how far the battery is charged or discharged.

No matter how expensive your radio set—whether it has one tube or many tubes—you must have the steady voltage and strong non-rippling current of a good STORAGE BATTERY for the best results.

Philco Radio Batteries deliver strong non-rippling current *without hum, roar or buzz*. You can buy them from your nearest Philco Service Station, Radio or Music Dealer.

Philadelphia Storage Battery Company, Philadelphia

PHILCO DYNAMIC RADIO BATTERIES

JOBBERs and DEALERs—Philco has brought radio batteries out of the cellar and put them in the living room. Our new Radio Manual tells how. Fill out coupon below and we will mail you a copy.

Name

Street..... City.....

State..... Jobber Dealer

★ Tested and approved by RADIO BROADCAST ★

At Last! Toroidal Radio Frequency Transformer

THE "doughnut" or toroid coil is simplicity itself and represents a new step in tuned radio frequency amplification. To the discriminating Radio Fan who demands the utmost of his receiver from the standpoint of distance, selectivity, sensitivity, and volume, the **SUMMIT TOROIDAL TRANSFORMERS** will prove a revelation. They are designed in accordance with modern transformer engineering principles, adding greatly to the efficiency of any receiver.

THE **SUMMIT TOROIDAL TRANSFORMERS** are used in exactly the same manner as the open radio frequency coils—they have the correct ratio and are self balanced and self neutralized. There are no stray fields, leakages, nor can they feed back, thus assuring the experimenter and radio set builder of correct operation without howling or squealing. Their low distributed capacity and low loss give the greatest distance and power possible.

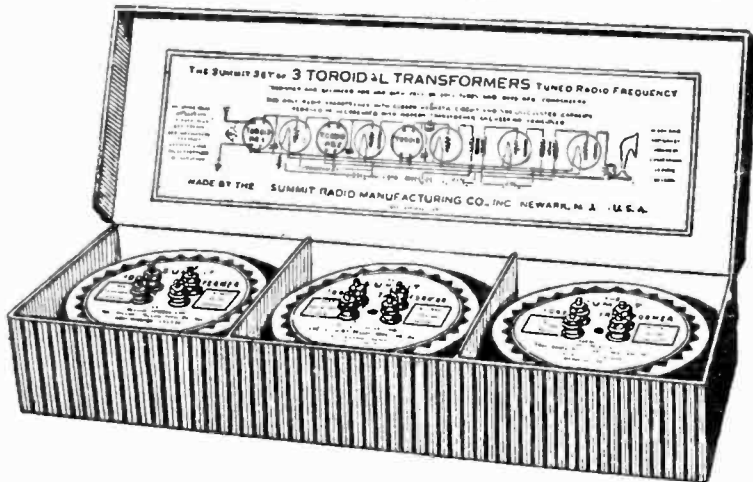

Diagrams and complete instructions for the assembly of the Five-Tube Summit Receiver enclosed with each set of transformers. The beginner in radio set building (if he follows these instructions) will experience no difficulty in producing a finished set that will do all and more than any other set of like size.

List Price (Set of Three Mated Units) \$10.00

Territory Open to Distributors and Jobbers

SUMMIT RADIO MANUFACTURING CO., Inc.

481 Broad Street

Dept. 20

Newark, New Jersey

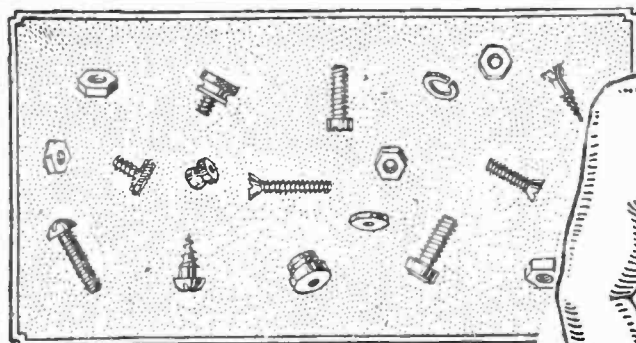

ONE C & C REACHIT

WRENCH TAKES THEM ALL

No necessity to pick over a half dozen wrenches to fit one nut when you use a REACHIT wrench.

It not only fits all sizes but automatically HOLDS THEM ALL firmly (with adjustable jaws) while getting into the intricate positions.

NO OTHER WRENCH CAN DO THIS

It assures a tight connection in the hard-to-get-at places.

A REAL TOOL FOR MECHANIC, ELECTRICIAN & RADIO BUILDER

Nickel finish—Hardened Jaws and Fully Guaranteed.

PRICE \$1.50

If your dealer cannot supply, will be sent post paid on receipt of above amount and your dealer's name

CAUFMAN & CLOUGH CO.
Wilmington Delaware

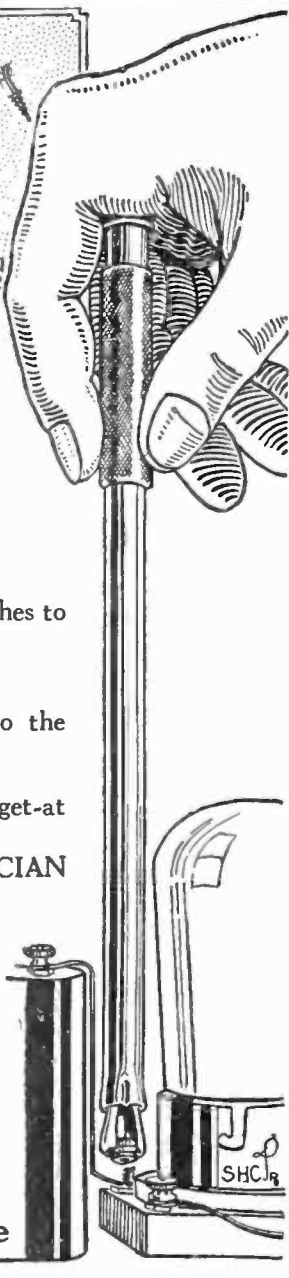

THE ANTENNAPHONE

gets **NEWCASTLE ENGLAND and MADRID SPAIN**

Replaces the Aerial

SAFER than a troublesome outdoor aerial
BETTER than an unsightly indoor aerial

The telephone is not attached to but merely placed upon the Antennaphone. Then connect the wire of the Antennaphone to the antenna post of your set (tube or crystal) and tune in.

Increases Selectivity and Quality of Reception

The Antennaphone will not interfere with the use of your telephone, and is **GUARANTEED** to work perfectly or your dollar will be refunded.

AT YOUR DEALER
or sent by mail upon receipt of one dollar

Correspondence solicited from Radio Jobbers and Dealers

The ANTENNAPHONE CO. 90 West St., N.Y.C.

90 West St., N.Y. City

Nov. 26, 1924

Gentlemen:

I am writing to let you know the results I have had with your product the Antennaphone

While past radio reception has been good, last night the Antennaphone proved its value to me when with same I was able to listen to Newcastle, ENGLAND and Madrid, Spain; the latter with fairly good loud speaker reception.

Yours very truly,
Houbert

Produce Exchange
New York City

ANTENNAPHONE
ANT. PHONE

\$1

★ Tested and approved by RADIO BROADCAST ★

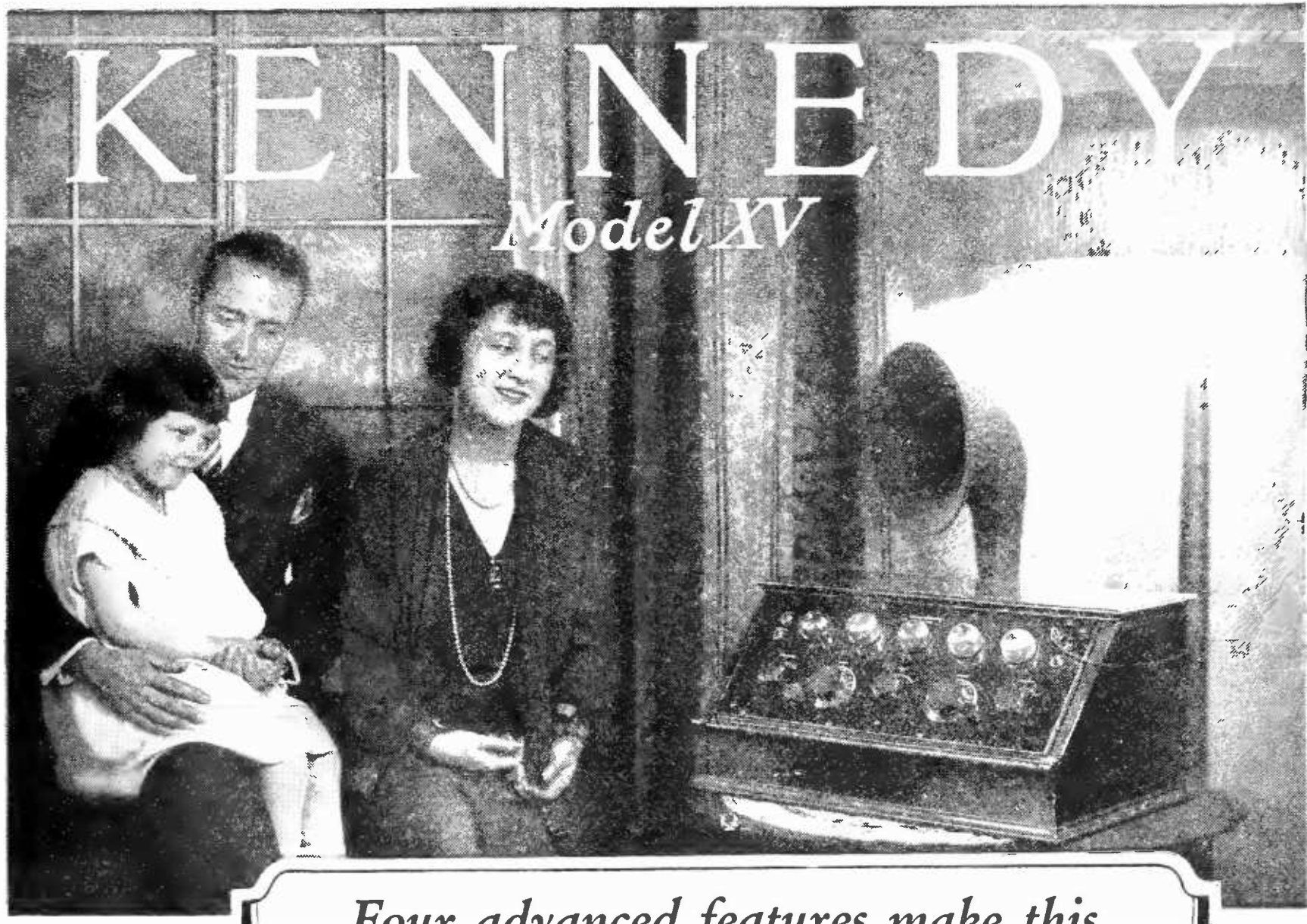

Four advanced features make this the most satisfying receiver you can buy

The Royalty



Selectivity

MODEL XV is so superselective that you can cut right through powerful local broadcasting and receive distant stations clearly. Not merely faint, fuzzy whispers, but firm, distinct reception without a trace of interference. In cities like Chicago, where conflicting stations make a broad tuning receiver useless, Model XV separates them completely so any local program can be chosen or all locals can be cut out and long range reception enjoyed. Users tell us they have logged over 150 stations from coast to coast and even across the seas.

Purity of Tone

KENNEDY receivers have always been noted for their fine tone quality. No other receiver of any type approaches the Kennedy in its bril-

liant reproduction of every shading of music and inflection of the voice.

Simplicity of Tuning

EACH station is always found at its own dial setting. There are only two tuning dials—one for each hand and none left over. Only one figure need be jotted down as the setting for any station. Both dial settings are practically alike. You can set the dials and name the station!

Volume on Distant Programs

STATIONS hundreds of miles away come in so perfectly, with loud-speaker volume, that your friends believe they must be local stations—until they hear the station call letters.

You must *hear* this receiver to appreciate its wonderful superiority.

Write for the address of a dealer who will demonstrate

THE COLIN B. KENNEDY COMPANY

Saint Louis

2018-2



★ Tested and approved by RADIO BROADCAST ★

Complete Parts and Accessories for Radio Broadcast's Perfect Receiver

Four-Tube Knock-out

Developed by Mr. Walter Van B. Roberts

Endorsed by the Director of Radio of the Canadian Government

and recommended to Canadians as the best, after exhaustive competitive tests and with a complete knowledge of performance. *Could you ask better proof of merit?*

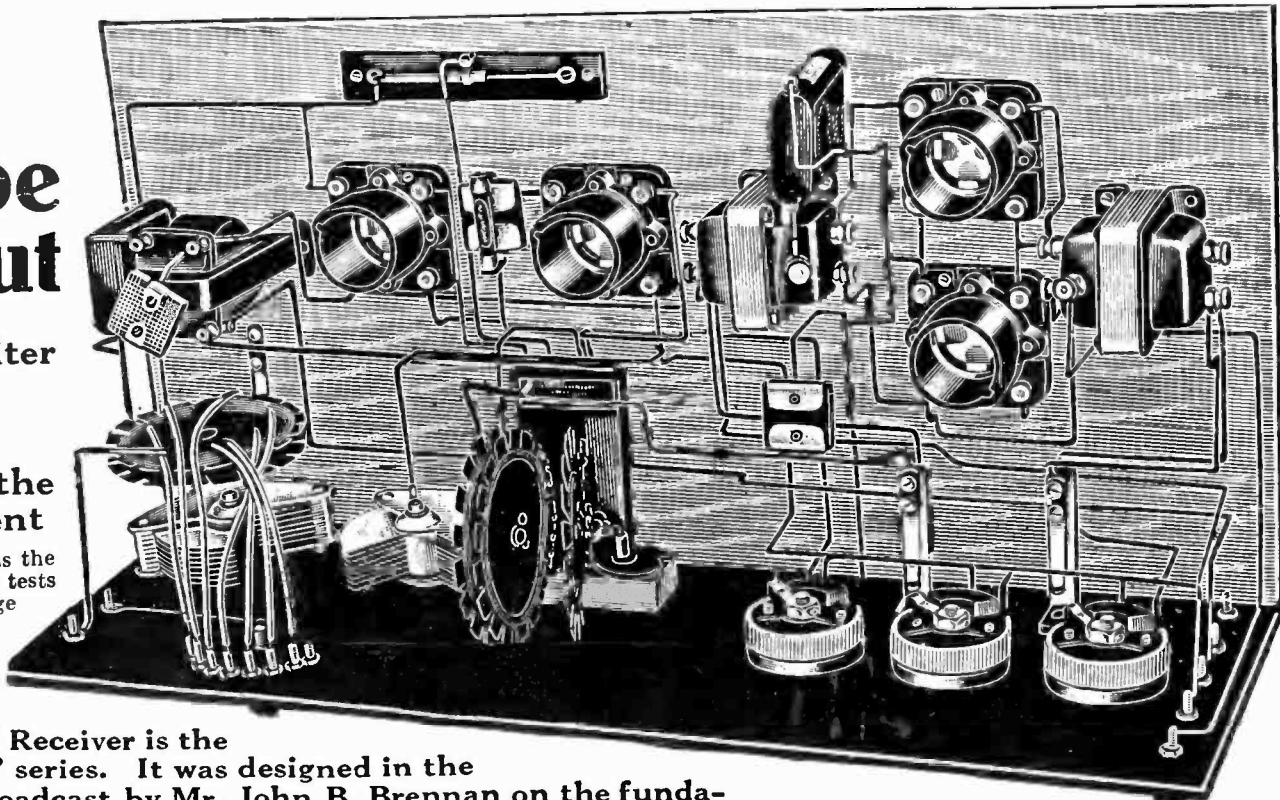

The Radio Broadcast four-tube "Knock-Out" Receiver is the Ace of the "Knock-Out" series. It was designed in the laboratories of Radio Broadcast by Mr. John B. Brennan on the fundamental circuit developed by Mr. Walter Van B. Roberts, one of the foremost radio engineers of this country.

READ—THINK WHAT THIS MEANS! COULD ONE ASK MORE?

It combines the principles of Reflex, Neutralization, Tuned Radio Frequency, Regeneration, (without blooping) and Push-Pull amplification. These principles give you in the Roberts Four-Tube "Knock-Out" Receiver *low first cost and low upkeep*, remarkable ease of tuning, the selectivity of the super-heterodyne, greater sensitivity than any other receiver ever designed for home construction, and volume enough for dancing. It is a thoroughly tried and developed receiver that met with instant approval and has stirred up *proud enthusiasm* and given *utmost satisfaction* everywhere. It is the ideal receiver for home construction! If you want the very best, we are offering it to you right now. You cannot possibly find its superior!

SEND NO MONEY

Shipped on approval—within 24 hours. You may examine at your express office before acceptance.

We pay all transportation.

Ideal set for expert or novice—may be assembled by a boy or anyone by following easy instructions. Said by customers to be "a masterpiece of simplicity." Very popular—no complaints.

Satisfaction guaranteed. Set returnable undamaged after reasonable trial, and money refunded if not pleased.

THIS IS WHAT YOU GET:

Complete Parts—1 Mahogany finish, piano polish, 7x21 Cabinet, \$5.00—1 Hard Rubber, drilled and engraved 7x21 Panel, \$4.00—1 6 1/2 x 1/2 20 Baseboard, \$3.60—1 set Roberts' Coils, \$8.00—2 U. S. Tool Co. 23-plate Variable Condensers, \$3.40 each, \$6.80—1 Micadon .00025 Grid Condenser, \$.35—1 Daven 2-megohm Grid Leak, \$.50—1 Micadon .0025 Fixed Condenser, \$.40—1 Micadon .005 fixed Condenser, \$.60—1 Neutralizing Condenser, \$2.00—3 Tillman 20-ohm Rheostats, \$.80 each, \$2.40—4 Federal Sockets, \$1.00 each, \$4.00—1 pair Como Push-Pull Transformers, \$12.90—1 Sherma-Tran 5 to 1 Transformer, \$4.65—1 Fada-type Inductance Switch, \$.25—7 Switch points, \$.10—2 Switch stops, \$.05—3 Univernier Dials, \$1.25 each, \$3.75—7 moulded Binding Posts, \$1.40—1 Millimeter closed-circuit Jack, \$.80—1 Millimeter open-circuit Jack, \$.70—2 Eveready type 771 "C" Batteries, \$.60 each, \$1.20—12 Lugs, \$.10—3 lengths varnished Tubing, \$.30 each, \$.90—12 lengths Bus Bar, \$.30—1 Instruction Book, with 2 Blue-prints, \$1.00. TOTAL, REGULAR PRICE, \$61.85.

14M165 Complete Parts \$48.30
Our price, transportation paid

Complete Accessories—2 Eveready 45 volt "B" Batteries, \$3.75 each, \$7.50—1 Westinghouse 70-ampere-hour "A" Storage Battery, \$15.00—1 pair guaranteed Headphones, \$4.50—1 Comsco Phone-Plug, \$1.00—4 UV-201A Tubes, \$16.00—1 Complete Antenna Equipment, \$4.00. TOTAL, REGULAR PRICE, \$48.00.

14M166 Complete Accessories \$38.14
Our price, transportation paid

14M167 Complete Parts and Accessories Regular Price \$109.84 \$84.79
Our price, transportation paid

If you have any of the items listed, order the remainder and we will charge you on the same basis as though you had ordered all.

BARGAIN CATALOG

Yours FREE! 100 Pages!

Just send your name

Get it now!

Crammed full of information & offers

of all kinds of complete **RADIO SETS, Parts and Accessories** including everything needed to construct the popular "Knock-Out" Sets developed and approved by Radio Broadcast magazine, published by Doubleday, Page & Co.—anything you may need to build or equip any set. You will enjoy dealing here. Get this wonderful catalog—you need it...write today!



Very interesting!

SEE OUR **16-PAGE AD** in January Radio Broadcast

Liberty Mail Order House
The Radio House of Friendly Service
Dept. B702 106 Liberty St. New York

The Largest Selling Transformers in the World

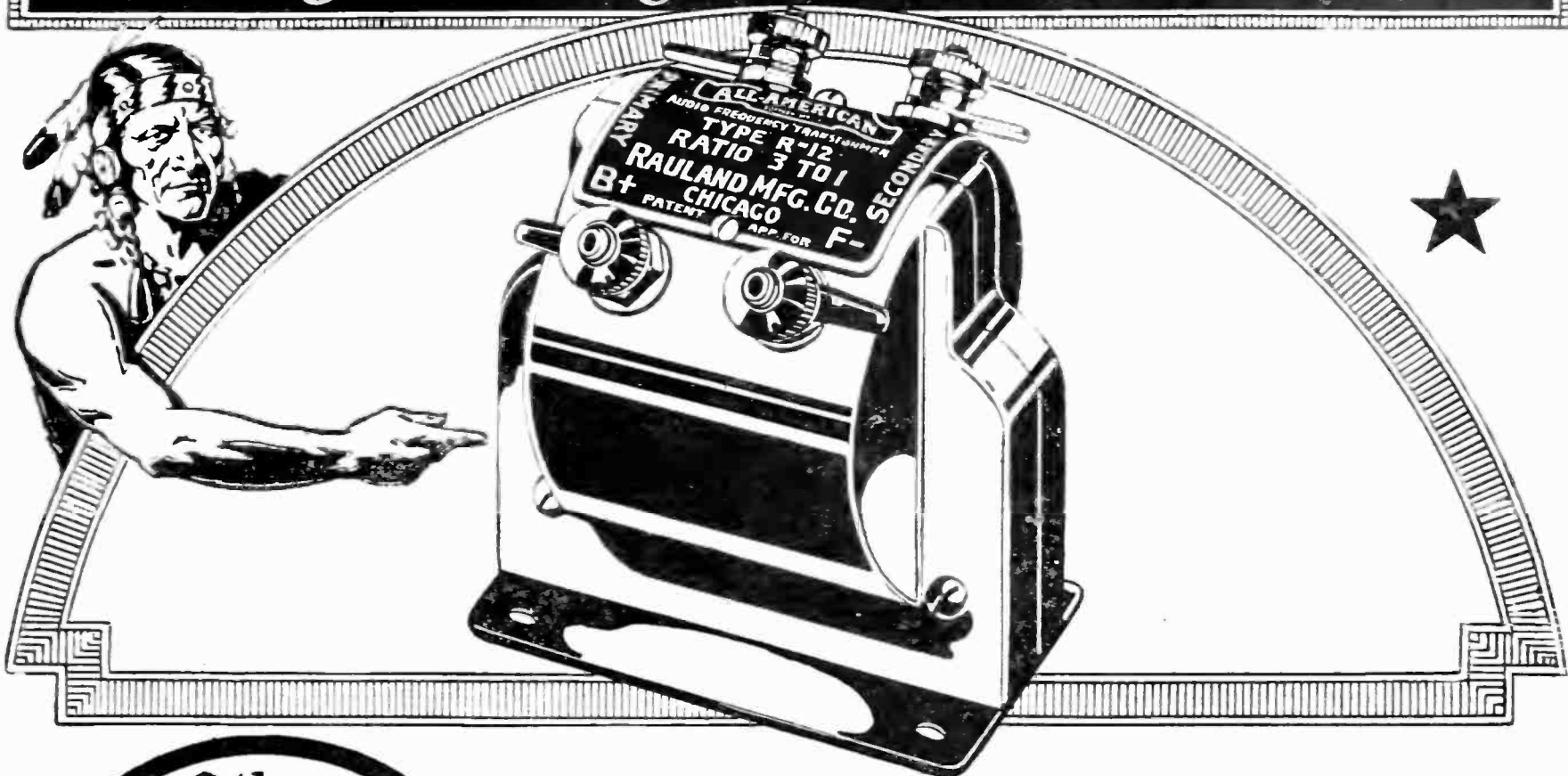

Other ALL-AMERICAN Guaranteed Radio Products

Power Amplifying Transformers (Push-Pull)

Input type R-30 \$6.00
Output type R-31 6.00

Rauland-Lyric

A laboratory grade audio transformer for music lovers. R-500.....\$9.00



Universal Coupler

Antenna coupler or tuned r. f. transformer. R-140 \$4.00



Self-Tuned R. F. Transformer Wound to suit the tube. R-199 \$5.00. R-201A \$5.00

Long Wave Transformer (Intermediate Frequency)

(15-75 kc.) R-110..... \$6.00

10,000 Meter (30kc.) Transformer

Tuned type (filter or input). R-120 .. \$6.00



Radio Frequency Coupler (Oscillator Coupler). R-130 \$5.00



Super-Fine Parts Consisting of three R-110's, one R-120 and one R-130 \$26.00

Reliable!

ALL-AMERICAN Standard Audio Frequency Transformers in any radio receiving set mean but one thing—assured efficiency in amplification. Since 1919 ALL-AMERICAN Audios have answered the demand for an instrument that could be relied upon for maximum amplification and faithful tone reproduction. Set builders who know radio do not experiment—they specify ALL-AMERICANS, with full assurance that they will consistently perform with highest efficiency.

Precision-Made

ALL-AMERICAN reliability is a natural result of ALL-AMERICAN precision manufacture. Each part is scientifically designed and accurately built to exact standards. Special machinery and testing equipment assist in achieving perfection.

3 to 1 Ratio \$4.50; 5 to 1 Ratio, \$4.75; 10 to 1 Ratio, \$4.75.

The Radio Key Book is the most valuable book of radio facts ever published. Sent for 10 cents, coin or stamps.

RAULAND MFG. CO.
Pioneers in the Industry
2652 Coyne Street Chicago

All-American Reflex Receivers

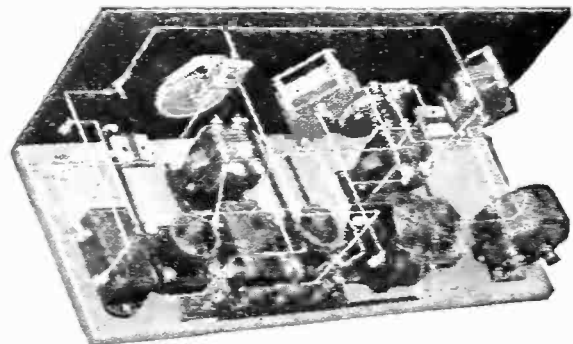

Complete receiving sets with range, volume and selectivity unequaled in receivers of this type. All instruments are mounted on panel and baseboard ready to be wired. Clear photographs, blueprints and a 48-page instruction book make wiring so easy as to be the work of only one delightful evening. All-Amax Junior (one-tube), (semi-finished) \$22.00 All-Amax Senior (three-tube), (semi-finished) \$42.00

ALL-AMERICAN

★ Tested and approved by RADIO BROADCAST ★

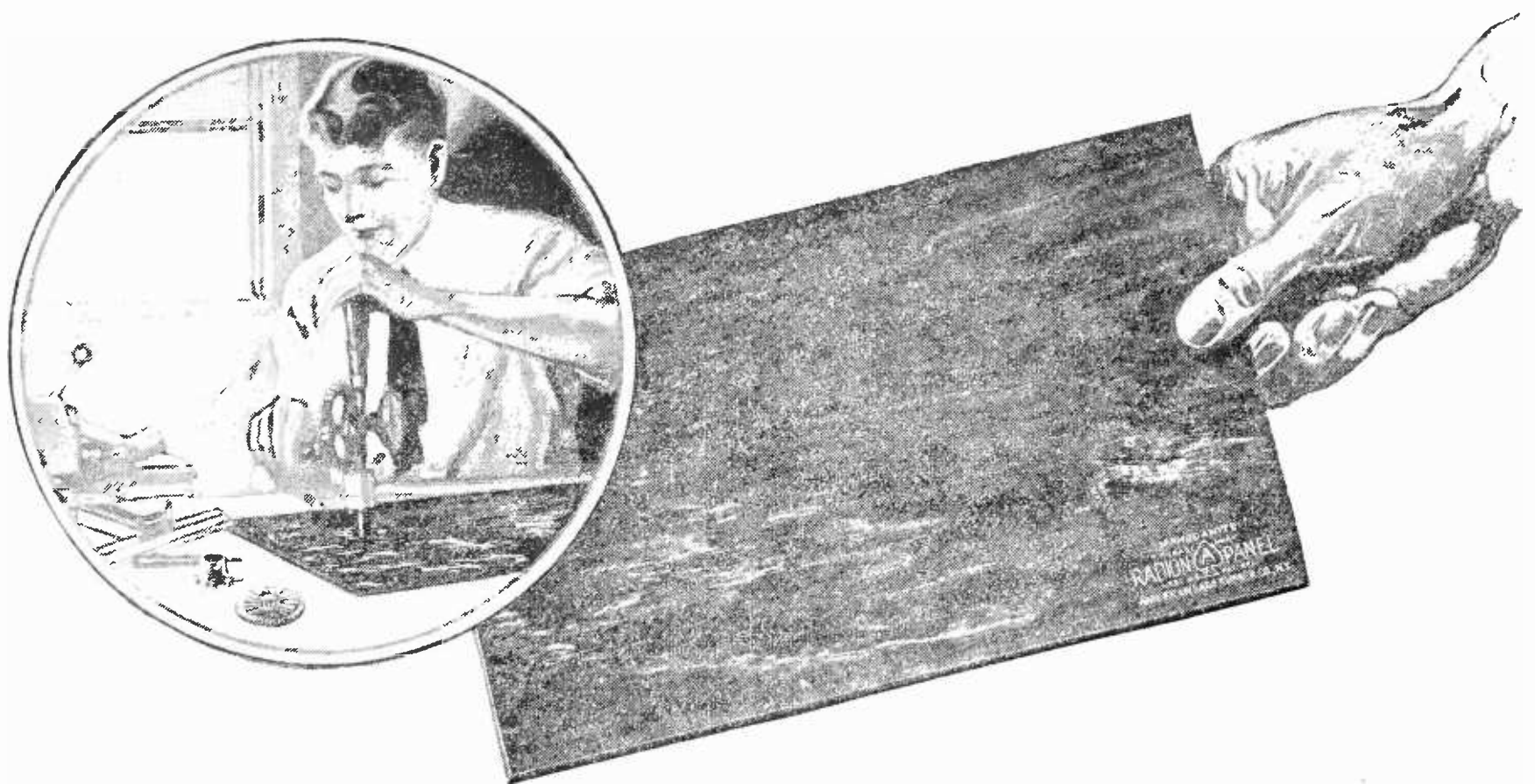

Just use ordinary tools on this panel —built to order for radio

YOU don't need special tools to do a good job on a Radion Panel. Just the usual tools found around any house will give you clean-cut, workmanlike results. You need not have the slightest fear of chipping.

Radion is the easiest of all to cut, drill, and saw. It was developed *to order* by our engineers to meet the demands of radio set builders. There is nothing quite like it for real results.

Highest rating as radio-frequency insulation

AUTHORITATIVE laboratory tests give Radion the highest rating as radio-frequency insulation. That means that losses from surface leakage and dielectric absorption are exceptionally low. And low losses mean clearer reception, more volume and more distance.

You can see that Radion is different by looking at the finish. But that high-polished,

satin-like surface is not for beauty alone. It's useful, too. Moisture and dirt cannot gather to cause leakage and leakage noises.

Radion resists warping. It's strong. It's moisture proof. It comes in eighteen stock sizes and two kinds, Black and Mahogany.

Better performance will make it worth your while to ask for Radion by name, and to look for the name on the envelope and the stamp on the panel. Radio dealers have the exact size you want for your set.

Send for booklet "Building Your Own Set"

Other Radion Products

The same qualities of low-loss insulation and attractive appearance characterize Radion dials (to match panel), binding post panels, insulators, knobs, etc.—also the new Radion Built-in horn.

Our new booklet, "Building Your Own Set," giving wiring diagrams, front and rear views, showing a new set with slanting panel, sets with the new Radion built-in horn, lists of parts and directions for building the most popular circuits—mailed for ten cents. Mail coupon to-day.

AMERICAN HARD RUBBER COMPANY, Dept. C-2, 11 Mercer St., New York City

Chicago Office: Conway Building

Pacific Coast Agent: Goodyear Rubber Co., San Francisco—Portland

RADION ★

The Supreme Insulation

PANELS

Dials, Sockets, Binding Post Panels, etc.

AMERICAN HARD RUBBER COMPANY
Dept. C-2, 11 Mercer St., New York City

Please send me your new booklet, "Building Your Own Set" for which I enclose 10 cents (stamps or coin.)

Name.....

Address.....

City.....State.....

★ Tested and approved by RADIO BROADCAST ★

ZENITH RADIO

TRADE MARK REG.



*Super-Zenith VII—
the ideal radio set
for the fine home*

*They Cost More
But They Do More*

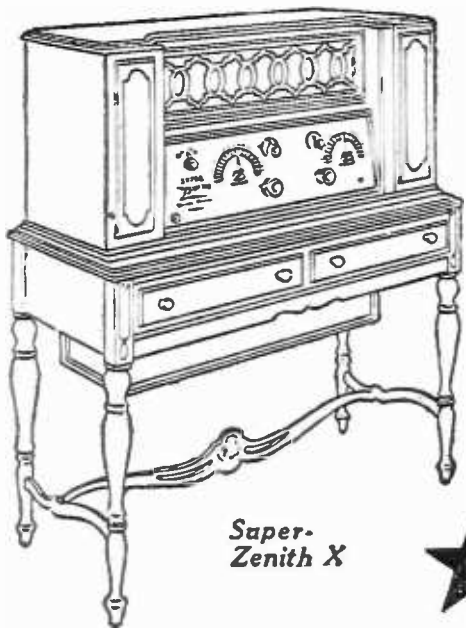

Super-Zenith X



Fulfills your utmost desire, in beauty and performance

The new Super-Zenith is beautiful to look at—lends an atmosphere of dignity and worth to library or drawing room.

Naturally you expect unusual performance from so beautiful a radio set. And—unusual performance is exactly what you *get*.

Tuning, for example, is controlled by *two dials only*—so perfectly adjusted that each station comes in always at the same dial settings. *It never varies*. Powerful locals may be on full blast, yet you can tune them out completely and bring in distant stations. Tone reproduction is always clear and true; the volume always adequate.

Before you make your choice, be sure to see and try the new Super-Zenith. A fifteen-minute test will give you a new standard of radio values, as applied to beauty of construction — and — *performance*.

Dealers and Jobbers: Write or wire for our exclusive territorial franchise

ZENITH RADIO CORPORATION

332 South Michigan Avenue, Chicago

ZENITH—the exclusive choice of MacMillan for his North Pole Expedition
Holder of the Berengaria Record

THE complete Zenith line includes seven models, ranging in price from \$95 to \$550.

With either Zenith 3R or Zenith 4R, satisfactory reception over distances of 2,000 to 3,000 miles is readily accomplished, using any ordinary loud speaker. Models 3R and 4R licensed under Armstrong U.S. Pat. No. 1,113,149.

The new Super-Zenith is a six-tube set with a new, unique, and really different patented circuit, controlled exclusively by the Zenith Radio Corporation. It is NOT regenerative.

SUPER-ZENITH VII—Six tubes—2 stages tuned frequency amplification—detector and 3 stages audio frequency amplification. Installed in a beautifully finished cabinet of solid mahogany—44 1/2 inches long, 16 1/2 inches wide, 10 1/2 inches high. Compartments at either end for dry batteries. Price (exclusive of tubes and batteries) \$230

SUPER-ZENITH VIII—Same as VII except—console type. Price (exclusive of tubes and batteries) \$250

SUPER-ZENITH IX—Console model with additional compartments containing built-in Zenith loud speaker and generous storage battery space. Price (exclusive of tubes and batteries) \$350

SUPER-ZENITH X—Contains two new features superseding all receivers. 1st—Built in, patented, Super-Zenith Duo-Loud Speakers (harmonically synchronized twin speakers and horns), designed to reproduce both high and low pitch tones otherwise

impossible with single-unit speakers. 2nd—Zenith Battery Eliminator, distinctly a Zenith achievement. Requires no A or B batteries. Price (exclusive of tubes) \$550
Price (without battery eliminator) \$450
All Prices F. O. B. Factory.

Zenith Radio Corporation
Dept. 2-D

332 South Michigan Avenue, Chicago, Ill.

Gentlemen: Please send me illustrated literature giving full details of the Super-Zenith.

Name

Address

★ Tested and approved by RADIO BROADCAST ★

Pipe Organ Music

\$10
Complete
with
Cord



WHEN the deep thundering notes of a pipe organ come in over your Needlephone and phonograph, then you will really appreciate how much better reproduction the Needlephone gives.

It's the principle of "magnified reproduction" that does it. The vibrations of the reed at "C" transmit the delicate impulses that come in over your radio to the pivoted needle where they are magnified at "A." As a result of this magnified reproduction, the Needlephone gives better, sweeter music than can be produced any other way. It is easily attached, requires no extra equipment and can be used with any phonograph including the Edison with Victor adapter.

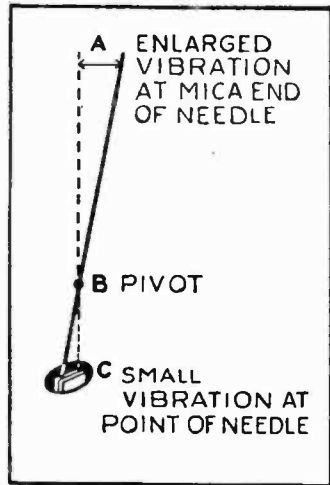

**Magnified
Reproduction
Principle**

Take No Risk—Send No Money
Send the coupon to-day. Try the Needlephone on your own radio and phonograph. If you can not say you get better reproduction—sweeter music—return it and Rhamstine* will refund your money in full.

Mail the coupon to-day! Do it now!

J. THOS. RHAMSTINE*
DETROIT
MICH.

J. THOS. RHAMSTINE* 2
506 E. Woodbridge, Detroit, Mich.

Send me the *Needlephone*. I'll pay the postman \$10 upon its arrival. It is distinctly understood I may return it if I desire, within 5 days and receive a refund in full.

RHAMSTINE*
Needlephone

Mail This
Coupon To-day

Name.....

Address.....

RAY-DE-O-CASE

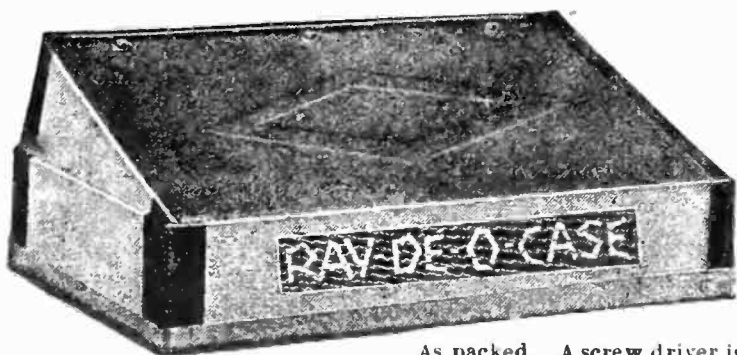

As packed. A screw driver is all that is required to assemble Ray-De-O-Case. It can be done in a jiffy.

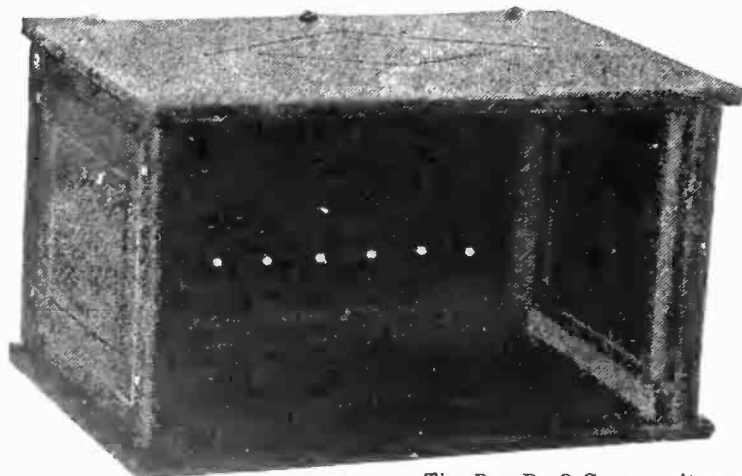

The Ray-De-O-Case as it appears when set up ready for your receiver.

Ray-De-O Case Will Meet Your Cabinet Requirements!

Ray-De-O-Case is a scientifically constructed and technically perfect radio cabinet built to fit any receiver from a one-tube set to a super-heterodyne. It is made in all standard sizes.

Its improved hinge arrangement with an automatic stop for the lid is a welcome feature that permits opening and closing without fussing with catches, etc. It is dust and water-proof and will not warp.

No base-board is required to build your receiver in the Ray-De-O-Case. Its sides are removable which permits receiver adjustment without taking the set out of the cabinet.

Proper openings are provided in Back Panel for all feed wires.

The Ray-De-O-Case is sturdily constructed and covered with genuine Du Pont Fabrikoid in either black, mahoganette, or walnette. It is a carefully designed, technically correct radio cabinet that is attractive in appearance and yet it costs less by about 35% to 60% than a solid mahogany cabinet.

Ray-De-O-Case is sold under a positive guarantee of satisfaction.

Ask your Dealer or write direct

Jobbers and Dealers are requested to write for information.

Knockdown Radio Cabinet Corp. ★

252-4 Railroad Ave.

Jersey City, N. J.

★ Tested and approved by RADIO BROADCAST ★

When Winter Winds Blow Cold

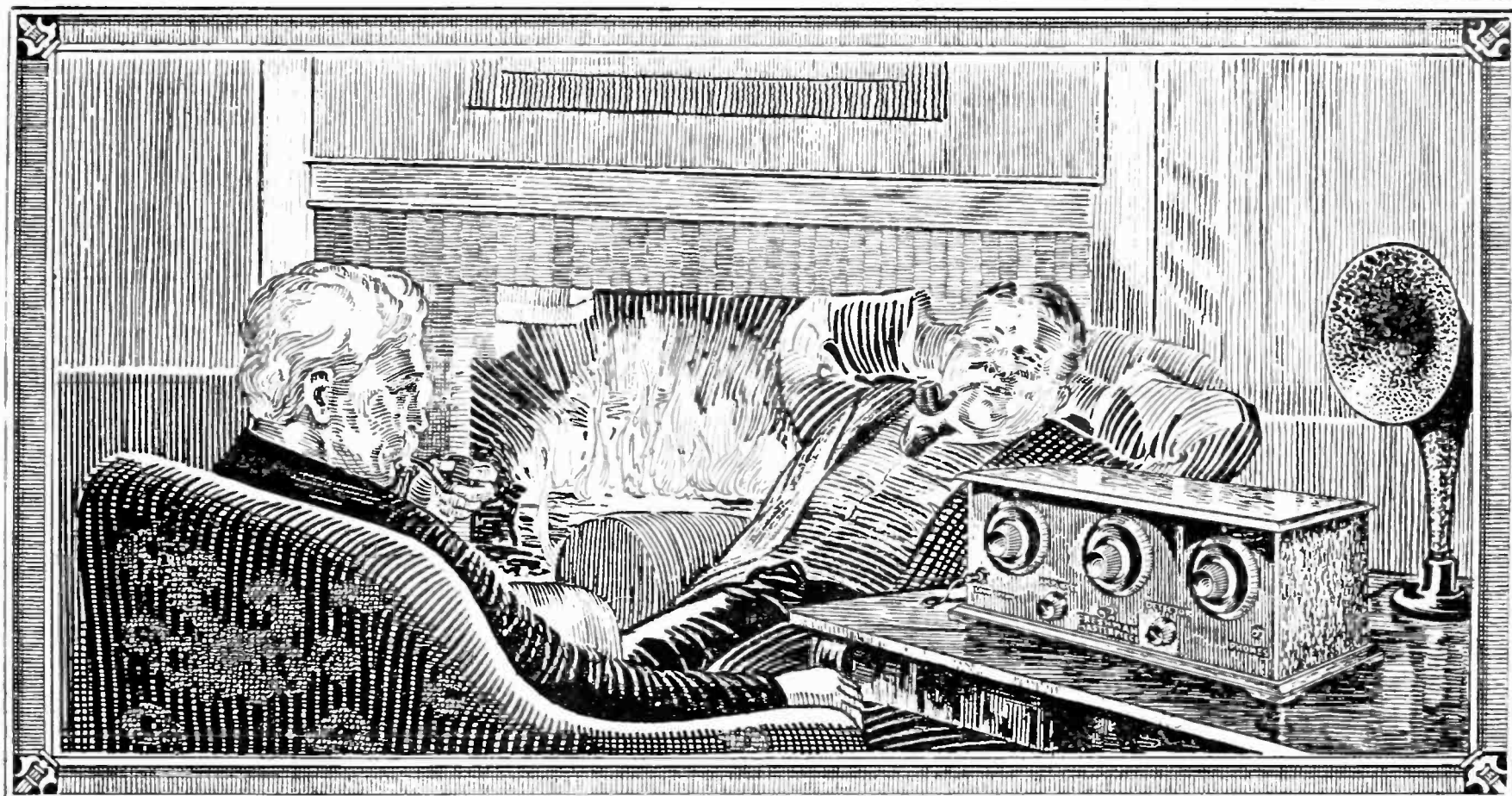

FRESHMAN MASTERPIECE

*The Greatest Value Ever Offered
In A Radio Receiving Set!*

A 5-tube Tuned Radio Frequency Set made of the finest low loss materials and in a beautiful genuine solid mahogany cabinet, that is attractive enough for the most pretentious room, and at sixty dollars, economical enough for the most modest.

Combines all points essential to the perfect receiver. Real distance reception without that squealing and howling. So selective that once a station is picked up—it can be brought in again on the same points on the dials, whenever you want it. And, what's more,



IT IS MIGHTY EASY TO OPERATE

Have Your Dealer Install One in Your Home!

All genuine Freshman Masterpiece Sets have a serial number and trade-mark riveted on the sub-panel. The Receiver is not guaranteed if number has been removed or tampered with.

Tuned Radio Frequency Kit

\$17.50

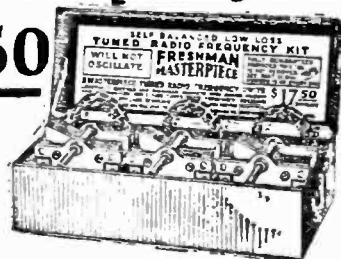

It's Easy to Build

a five-tube radio frequency receiver when you use the Freshman Masterpiece Kit. The result will be a receiver that will bring in even the most distant stations with the volume and clarity of locals. The equal of any 5-tube set in selectivity, simplicity of operation and all-around efficiency.

*No Neutralizing or Balancing
Condensers Required*

Chas. Freshman Co. Inc.
Radio & Condenser Products

FRESHMAN BUILDING

240-248 W. 40th St., New York

★ Tested and approved by RADIO BROADCAST ★

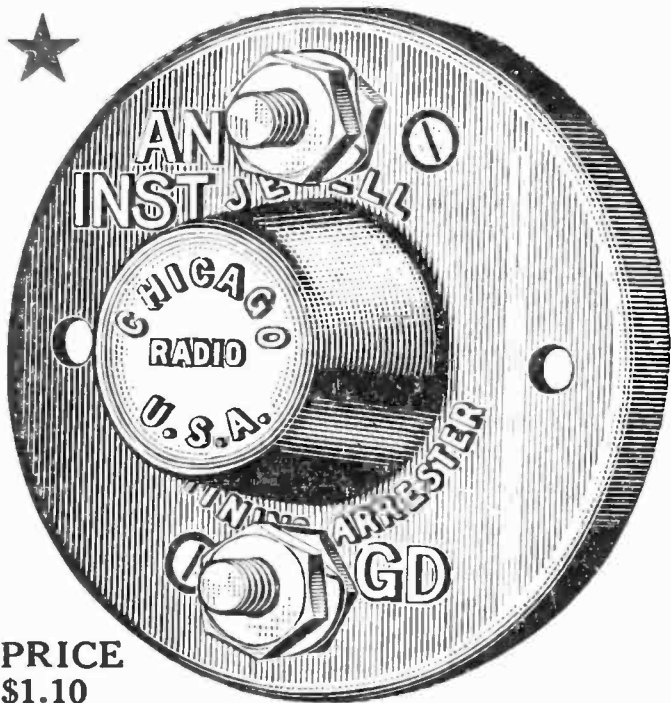

PRICE
\$1.10

LIGHTNING ARRESTERS

Are Required by the Underwriters

Ask your insurance agent to show you the Underwriters Radio Requirements.

The Jewell Lightning Arrester, in its brown porcelain case, has successfully passed the Underwriters' Tests. (No. E 5403).

Buy from Dealer

Jewell Electrical Instrument Co.

1650 Walnut St.

Chicago

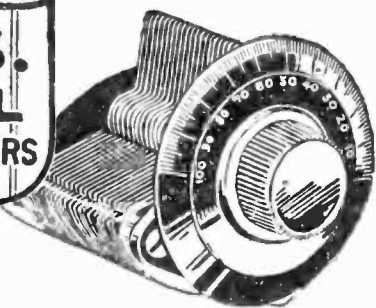

A Unique U. S. Tool Feature ONE PIECE STATOR

(Pat. Applied for)

Found in no other make, the one piece stator makes the U. S. Tool Condenser 100% efficient. Eliminates leakage, resistance, broken contacts and soldered joints. In types 3 (plain) and 4 (all-vernier), **Celoron End Plates**; types 5 (plain) and 6 (all-vernier), **Metal End Plates**; types featuring the Hexagon Shaft.

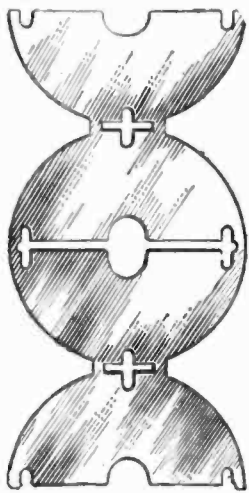

CS and CV low price types always in stock.

100% GUARANTEED

Write for Folder

U.S. TOOL COMPANY, Inc.
125 Mechanic Street NEWARK, N. J.
Mfrs. of Special Tools, Dies, Jigs, Automatic Machinery and Sub Presses



PYRATEK

TRADE MARK



FIXED Crystal Rectifier

Guaranteed to give utmost sensitive reception with absolute stability. Especially designed for REFLEX work.

Used by
SLEEPER RADIO CORP. (Monotrol Sets)
DAVID GRIMES, INC. (Inverse Duplex Sets)
RADIO RECEPTOR CO. INC. (Multiflex Sets)

Tested and recommended for the "Knock-out" Reflex by "Radio Broadcast" Laboratory.

WITH MOUNTING CLIPS \$1.25

At your dealers or sent direct upon receipt of purchase price
THE ERISMAN LABORATORIES. 3785 Broadway, New York, N. Y., Dept. C

PATENTS Secured Trade Marks Registered Radio Inventions A Specialty Write Us

MASON, FENWICK & LAWRENCE
Patent and Trade Mark Lawyers
Washington, D. C., New York, Chicago
ESTABLISHED OVER 60 YEARS

References: National Confectioners' Association, Chicago. National Canners' Association, Washington, D. C. Life Savers Inc., Port Chester, N. Y. Bon Ami Co. and U. S. Cigar Co., New York City. Hershey Chocolate Co., Hershey, Pa. Stephen F. Whitman & Son, Philadelphia, Pa., and many others

★ Tested and approved by RADIO BROADCAST ★

WANTED

at \$3,000 to \$10,000 a year



Yes—\$3,000 to \$10,000 a year! These are the opportunities that exist everywhere today for big, easy money in Radio. Radio is the fastest growing industry in the world. If you are in a routine job with poor pay and no future, here's the chance of a lifetime. Investigate! Look into the amazing money-making possibilities of Radio. In a few short months of training at home by mail, we can make you an expert representative of our Association. Learn to install, repair, build and sell high-

grade radio sets. Become the Radio expert of your neighborhood. Find out how the Radio Association of America now makes all this easy for you. Radio offers not only big-salary jobs, but is a business you can easily get into for yourself.

Become a Radio Expert

Train at Home in Three Months Get your share of the big money being made in Radio.

Mail the coupon for free information. Find out how in your spare time at home, without giving up your present position or losing a dollar of pay, you can become a Radio Expert in a few short months. No previous experience is necessary. For the man who prefers a salary, big-pay jobs are waiting with the U. S. Government, Steamships, Railroads, and thousands of corporations and business houses. For the man who wants to get into business for himself and be independent, Radio offers unlimited possibilities—either on a spare or full time basis. In no other line can ambitious men find the opportunities that Radio now offers. You can train under one of America's leading Radio authorities. Read Mr. A. G. Mohaupt's offer to train you personally in everything about Radio—construction, installation, repairing and selling. By enrolling with us now you get the benefit of the direct personal guidance of this well-known expert.

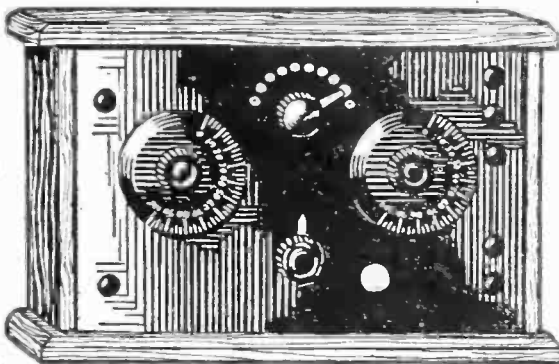

FREE—1000 MILE RADIO OUTFIT

This set when completed has a range of over 1000 miles. Right now we give it free to each member taking our course of training. Mr. Mohaupt's clear, simple instructions will show you how to build similar sets to sell at a big profit. When you have finished the course, you can sell this free set at a price that will practically pay the cost of your training.

Get The Facts—Mail Coupon

Radio knowledge is not only interesting and the means to the greatest form of entertainment the world has ever known, but is the most cashable knowledge a man can possess. Let us prove to you that there is nothing difficult about Radio—that any intelligent person can easily learn it right at home by mail under our simplified and approved methods. Mail the coupon now for all the facts. Let us prove that Radio is easier to learn and offers bigger money than any other business or profession you can get into. Don't wait—act while our Free Offer of a 1000 mile radio outfit is still in effect.

A. G. MOHAUPT, Radio Engineer
RADIO ASSOCIATION OF AMERICA
 4513 Ravenswood Avenue Chicago, Ill.



A. G. MOHAUPT, B. A., M. S.

Head of the Radio Association of America, Graduate Electrical Engineer, University of Wisconsin. Former Radio Instructor for U. S. Government. Author of "Practice and Theory of Modern Radio."

"I give my personal attention to every student taking my course. Your individual problems and questions are answered by myself. I work with you at every stage of the course, guiding you, directing you to your goal to be a Radio Engineer in the big-pay class. My course prepares you to successfully pass Gov't examination for Operator's License."

Radio Association of America,
 Dept. B-2
 Chicago, Ill.

Please send me details regarding your Expert Home Training Plan and offer to representatives, also your offer of a 1000 mile Radio Set FREE.

Name.....

Address.....

City..... State.....

—here
it is!

“A wonderful set”—Radio editors of five Boston papers

(Patents Pending)

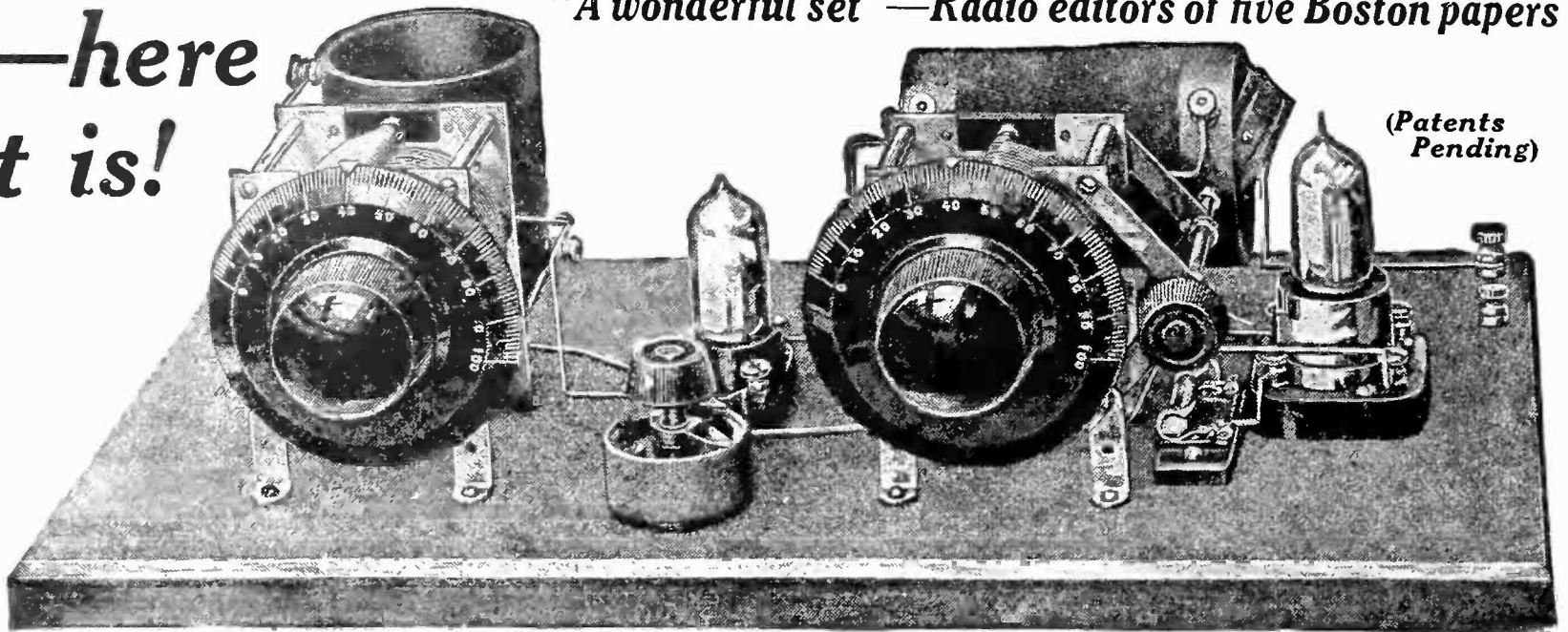

THE NATIONAL REGENAFORMER KIT for the Browning-Drake Receiver

CONSISTING OF

1 NATIONAL REGENAFORMER 1 NATIONAL ANTENNA INDUCTANCE 1 NATIONAL .0005 Velvet Vernier
CONDENSER WITH 4" DIAL 1 SET OF HARDWARE 1 NATIONAL .00035 Velvet Vernier CONDENSER
WITH 4" DIAL 1 SET OF INSTRUCTIONS FOR WIRING

Regenaformer
and
Antenna Coil
only—Price \$7.50

PRICE
\$22.00

Coils completely
mounted on back of
Condensers
ready for wiring

Sets made with this Regenaformer Kit have spanned the continent.

Send for Bulletin 105RB

Mfrd. by NATIONAL CO., Inc., 110 Brookline St., Cambridge, Mass.

Heard across the seas

Mr. H. W. MacKelvie, 7 Carlton Terrace, Swansea, South Wales, England, writes: “I was testing my one valve set between 1 and 2 o'clock in the morning when I was surprised to hear K.D.K.A. or Pittsburgh.”

Evidently there is no limit to long distance reception with Myers Tubes. Their design is right.

Three types for dry and storage batteries. Complete with clips ready to mount. At your dealer's or sent postpaid for ...

\$4

251 Craig Street, Montreal ★

Myers Tubes

Practically Unbreakable

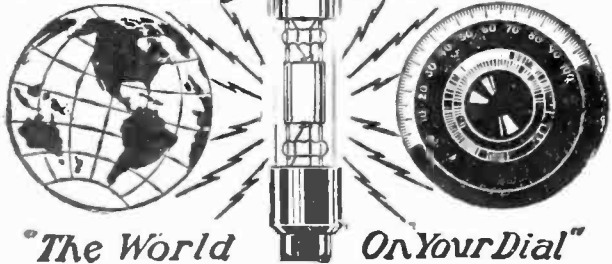

“The World On Your Dial”

Write for descriptive circular

DX “mushy”?

FREE BOOKLET

On “Tube Control” tells how to bring in distant stations clear and loud. Just drop a postcard to

UNITY MFG. CO.
230 North Halsted Street
CHICAGO, U. S. A.

CHASE INDUCTANCE COILS
New—1925—Type (Concentrated Magnetic Field) Patent Pending

USE THE BEST

ORDER CHASE COILS

DO IT NOW

Balanced R. F. Transformers
Special Super-het. Oscillators
Three circuit regenerative
Teledyne

High-Mu
Harkness
Browning-Drake
Tertiary System

R
O
B
E
R
T
S



C
O
I
L
S
E
T

CHASE RADIO

41 Forest St., Springfield, Mass.

★ Tested and approved by RADIO BROADCAST ★

Announcing
the Latest
Development in
Radio Reception

Just ONE Dial To Tune ★

Just *ONE* Dial to Turn to Get Coast to Coast Range
 Just *ONE* Dial to Adjust to Get Perfect Tone Reception
 Just *ONE* Dial to Tune to Get the Utmost in Selectivity

YEARS AHEAD in perfected, simplified tuning and in loud speaker volume, the sensational new Mohawk is the first and only true *ONE* Dial Control for a 5-tube coast to coast radio set. It is fundamentally and essentially conceived and constructed to be a loud speaker receiver. Without headphones the Mohawk's *ONE* Dial will tune in stations all across the country direct on the loud speaker for everybody to hear. Even more delightful, the super-selectivity of this *ONE* Dial tuning goes far above the average. It will cut through the nearby stations with unfailing precision and bring in the distant ones loud and clear. Children can do it—elderly people—any member of your family and friends.

Never before has there been this freedom from the difficult task of carefully adjusting several complex controls. And in your home Mohawk beauty of appearance will again increase the pleasure of its wonderful performance with just *ONE* Dial. Table model, console and consolette are each built in distinctive period type Adam-Brown walnut cabinets. The console and consolette have built-in loud speaker, also battery compartments. Every model is broadly, fully guaranteed.

MOHAWK ELECTRIC CORPORATION

2226 Diversey Blvd., Chicago, Ill.

DEALERS:—Limited territory still available. Write or wire at once for Complete Information on attractive Mohawk Franchise.

The Mohawk
5 Tube Receiver

WRITE for descriptive circular giving complete information and prices on the three Mohawk models.

★ Tested and approved by RADIO BROADCAST ★



RADJO

Low Loss Tuner

Install a Radjo Low Loss Tuner in your old tube set and increase its **EFFICIENCY** and **SELECTIVITY**. Wound by the Lorenz type of winding. Single, Double or Three Circuit Tuners.

Price Each \$5.50

RADJO
LOW LOSS
PRODUCTS

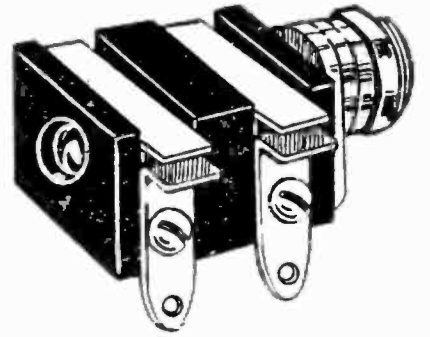

RADJO

**Anti-Capacity
Jacks and Switches**

Minimum of electrical capacity, wiping contact rugged and compact. The Radjo is one-third the size of other jacks and fits any standard plug. It assures minimum resistance.

Prices 70c to \$1.00

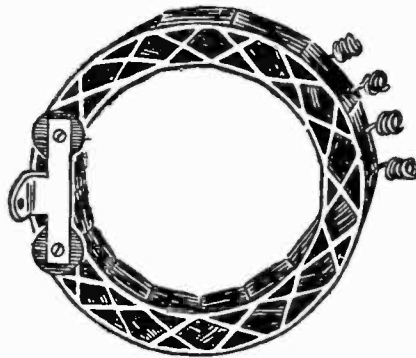

**"RADJO" Low Loss
Radio Frequency Transformer**

No dielectric Absorption losses. Minimum distributed capacity gives increased clarity, volume and selectivity. For

**Easy to Mount
Increases Distance Range**
use in Tuned Radio Frequency Neutrodyne and Reflex circuits . . . **PRICE, \$2.00**



FREE!

You owe it to yourself and your set to learn about Radjo Low Loss Products. Send to-day for interesting literature. It's free.

Dealers and Distributors Wanted—Write for Proposition

ELECTRIC CITY NOVELTY & MFG. CO.

Licensed Manufacturers

SCHENECTADY, N. Y.

The
Quiet NILES

Battery Charger

Your Battery's Best Friend

It does away with the trouble and waste of run-down, damaged batteries. Easy to operate. Light to handle. Delivers 72% of the current. Rich crystalized black finish. No bulbs. No liquids. No fumes. Model A for 6-volt batteries, \$19.00; Model AB for 6-volt and 24-volt batteries \$21.00. Add \$1 west of Rockies.

Write for Literature

NILES MANUFACTURING CO.
Dept. 82 Ypsilanti, Mich.

KESTER Radio SOLDER
(Rosin-Core)

*If your dealer cannot supply you
send us 25c in postage*

CHICAGO SOLDER COMPANY
CHICAGO, U. S. A.

RADIO

Big, complete stock. Standard prices. And you're sure it's reliable if it comes from Andrae.

Send for our catalogue

JULIUS ANDRAE & SONS CO.
112 Michigan Street Milwaukee, Wis.

ANDRAE *In Business Since 1860*

TWIN-AUD facts!

You, too can get greater volume and clearer reproduction with Peerless Twin-Aud because of its two stages of balanced amplification.

List Price \$9.50

AT ALL GOOD DEALERS
You Want—TWIN-AUD the double audio transformer

PEERLESS RADIO CORPORATION
Newton Lower Falls Boston, Mass.



A new Tungar!

The new Tungar does all the old Tungar did—and more. It will charge both radio A and B batteries, with no change except slipping the wire from one terminal to another. It charges 2, 4 or 6 volt A batteries — 24 to 96 volt B batteries — and auto batteries, too.

It is simpler than ever to use. Just two clips and a plug. No need to disconnect your battery from your set, or make any change in the wiring. The Tungar charges overnight while you sleep. And it makes no disturbing noise.

It is more compact than ever. It has a new bulb, unchanged in principle, but more convenient in size and use. G-E research has made a good product better!

Keep your batteries charged with a Tungar — and get the most out of radio.



300,000
Tungars
already
in use!

The new Tungar charges both radio A and B batteries, and auto batteries, too. Two ampere size (East of the Rockies) . . . \$18

The Tungar is also available in five ampere size (East of the Rockies) . \$28

60 cycles—110 volts

Tungar

REG. U.S.

PAT. OFF.



BATTERY CHARGER

Tungar—a registered trademark—is found only on the genuine. Look for it on the name plate.

Merchandise Department, General Electric Company
Bridgeport, Connecticut

GENERAL ELECTRIC

★ Tested and approved by RADIO BROADCAST ★



Ordinary houselighting current (110 volt, 60 cycle, alternating) transformed into the same sort of current as was formerly obtained from "B" batteries. Takes up little more room than one 45 volt "B" battery. Entirely contained in a neat metal box—6" wide by 4½" deep by 10" long. Uses one or two UV-201A or C-301A vacuum tubes.

*Never Failing
"B" Current from Any
Electric Light Socket*

*The MU-RAD
B-Radicator*

UNIFORM "B" power night after night—without renewing batteries—direct from the nearest electric light socket. No more diminishing current, no loose connections and costly, bothersome replacement. Requires no more attention

than simply screwing the plug into the electric light socket. Supplies current for any set up to 8 tubes at a cost less than that of burning one 10 watt lamp. No adjustments, nothing to wear out.

Write for Literature

MU-RAD LABORATORIES, INC.

803 FIFTH AVE., ASBURY PARK, N. J.

Keep your Radio / set Clean !

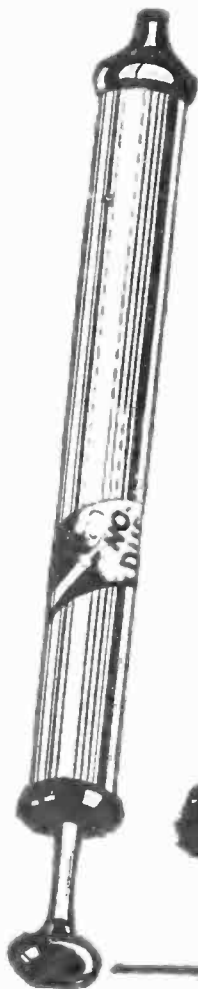

Here's a brand new article that every radio fan needs! You must have a NODUST to keep your set working its best. Each stroke of a NODUST forces a blast of compressed air into all the hard-to-get-at places and cleans out every speck of dust and dirt in a jiffy.

The NODUST is made of light, durable material, 12 inches long. Wooden mountings to prevent short circuiting. Will last a lifetime of service. If your dealer has not received his NODUSTS yet, we will send you one on receipt of one dollar.



**PEIFFER
&
COMPANY**
86 Liberty St.
Newark, N. J.

YOUR CRYSTAL SET

will work 400 to 1,000 miles if made by my plans. No tubes or batteries. Copyrighted plans, \$1.00; or furnished FREE with complete parts for building set, including special coil and panel correctly drilled for only \$5.00. Satisfaction guaranteed or money refunded. Satisfied customers everywhere. Particulars free.

LEON LAMBERT, 673 Kaufman Bldg., Wichita, Kansas

VOLT-X VARIABLE GRID LEAK

NEW!

A BALL-BEARING Grid Leak that stays put. Screw adjustment, expansion contact, and resistance unit that cannot wear or tear.

Volt-X Grid Leaks are positive and smooth in action with an accurate range of from one-half to fifteen megohms.

They fit any standard leak mounting, and get the absolute maximum from your tubes. They do not wear out.

Grid Leak \$1.00
Grid Leak Mounting .30



**BURTON & ROGERS
MFG. CO.**
755 BOYLSTON ST. BOSTON, MASS.

• IN STOCK •

Ready for Immediate Delivery—



Complete Line of Radiolas

Radiola III	\$35.00
Radiola Balanced Amplifier	30.00
Radiola III A	90.00
Radiola Regenoflex	191.00
Radiola X	245.00
Radiola Super Heterodyne	269.00
Radiola Super VIII	425.00
Radiola Loud Speaker UZ 1325	25.00



We can promise stock shipment because we are one of the largest RCA distributors and placed ample orders with the Radio Corporation of America to take care of our dealers.

Wire in your order now—we'll ship immediately.

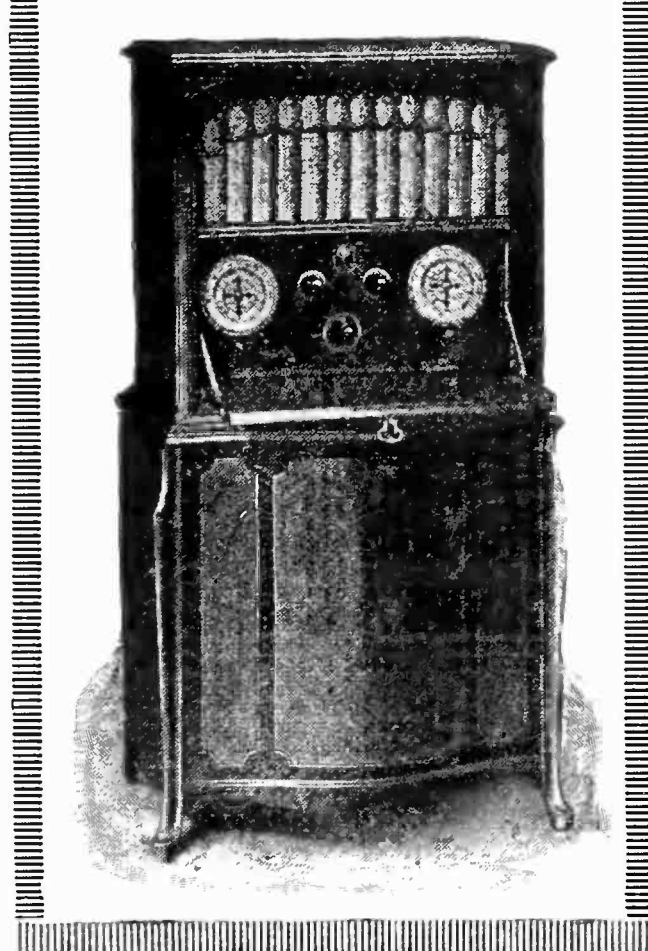
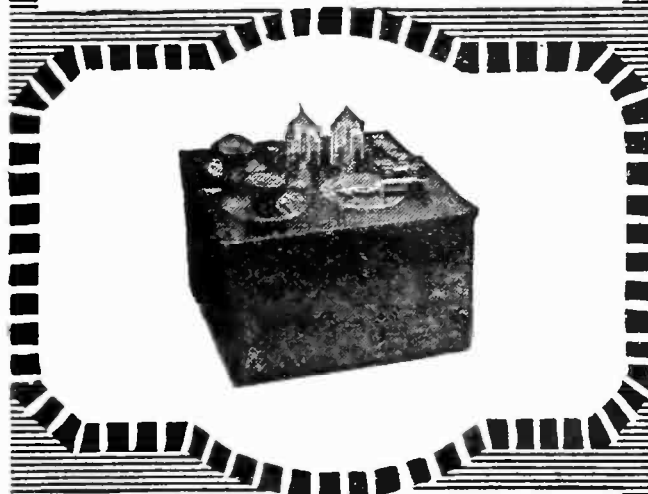
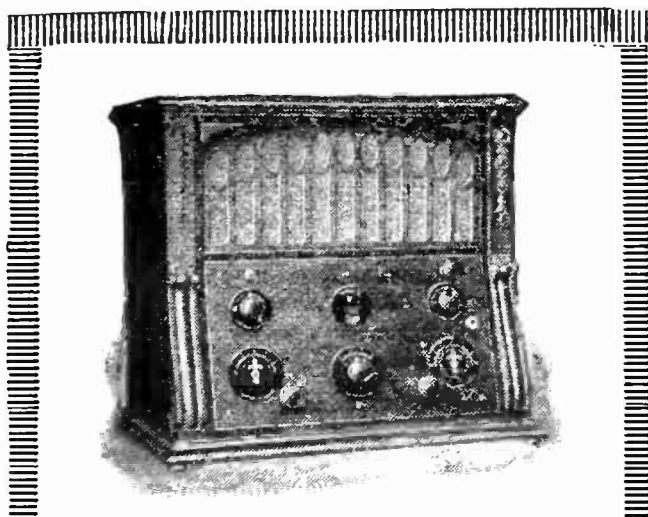

WHOLESALE

EXCLUSIVELY

LUDWIG HOMMEL & CO

929 PENN AVENUE



PITTSBURGH, PA.

★ Tested and approved by RADIO BROADCAST ★

Visco Vernier Dial

A vernier dial operating on a new principle. No gears, hence NO BACK LASH.

Both the quick and the precise adjustment without changing the grip or changing gears (there being no gears).

A moderate pressure will turn the dial quickly to any desired position and with a light pressure it will creep without jerk or jar precisely to a hair line adjustment. Always ready.

Helps to steady condensers with loose bearings.

Efficient, Practical and Cheap

To install, it is only necessary to take off the old dial and put on the new.

Genuine Bakelite, $3\frac{1}{4}$ inches in diameter, fits $\frac{1}{4}$ inch shaft.

If after 10 days trial you are not satisfied, return the dial and we will return the purchase price.

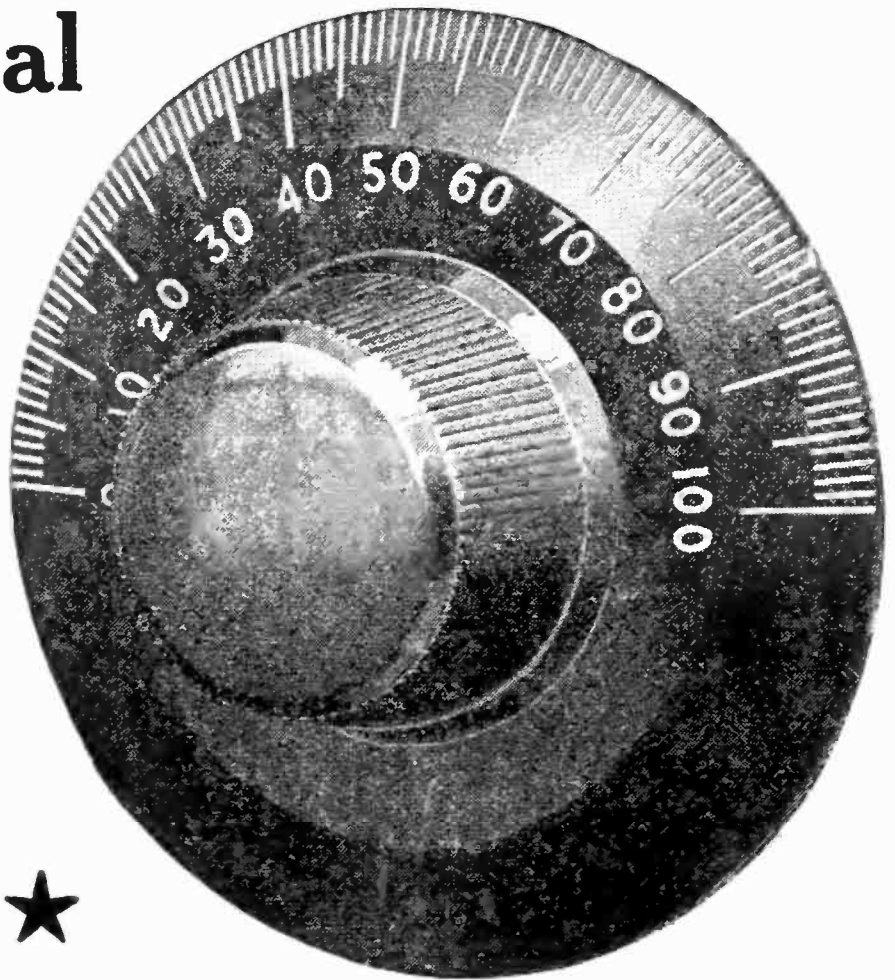

Price \$1.00 Postpaid

★
THE MONOSMITH BROTHERS CO.
SPENCER, OHIO

Buy for Results

The original and correct design and superior construction of Yaxley Approved Radio Products guarantee the best results for you. ★

YAXLEY

Approved Radio Products **Rheostat**

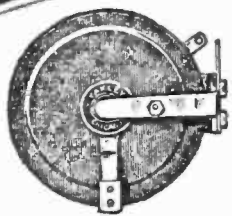

Gives fine tuning without use of vernier attachments. Has one nut mounting in single panel hole. Can be turned in any position to suit your wiring layout. You will like these and the other features of this new efficient rheostat. Fully guaranteed.

6, 20 or 30 ohm, with knob, \$1.35
6, 20 or 30 ohm, with dial, \$1.60

Potentiometer

Same construction as Rheostat
200 or 400 ohm,
\$1.85.

Jacks
Plugs
Switches
Resistance
Units, etc.

Ask your dealer, or send
his name with your order to

YAXLEY MFG. CO.
Dept. B, 217 No. Desplaines St., Chicago

“Reading Carpenter’s World Travels is seeing the world.”
For sale wherever books are sold.
Price, per volume, \$4.00.

Doubleday, Page & Co.

RADIODYNE

NO LOOPS—NO AERIAL ★

Ready for operation by grounding to a water pipe or radiator and throwing a few feet of wire on the floor. Uses any standard tubes—dry cell or storage battery. Extremely selective Simple to operate—only two controls. Wavelength from 200 to 700 meters. Write for Folder describing this (antennaless) receiver.

WESTERN COIL & E. CO.
318 Fifth Street Racine, Wis.

VESCO SMILES AT MILES

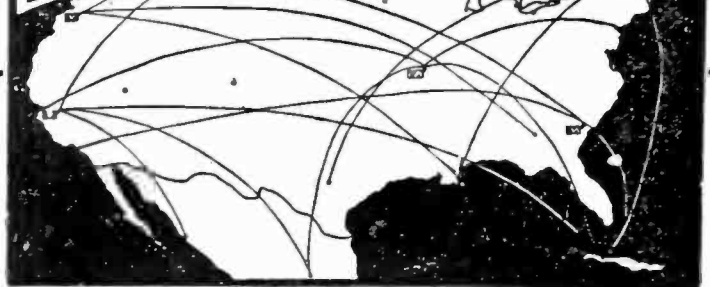

ON ONE TUBE

BIG FREE BOOKLET tells the story. California users of CROSS COUNTRY CIRCUIT hear Atlantic Coast. Canada, Cuba, Mexico, and Hawaii. Atlantic Coast users hear England to California. Our new plan makes this set easiest and cheapest to build. One hour puts in operation. One tuning control. No soldering. Any Novice can do it. BIG BOOKLET FREE or complete instructions for 25c stamps or coin.
VESCO RADIO CO. Box RB-117 Oakland, California

★ Tested and approved by RADIO BROADCAST ★

W O R K R I T E R A D I O S E T S W O R K R I G H T

The WorkRite CHUM

\$65

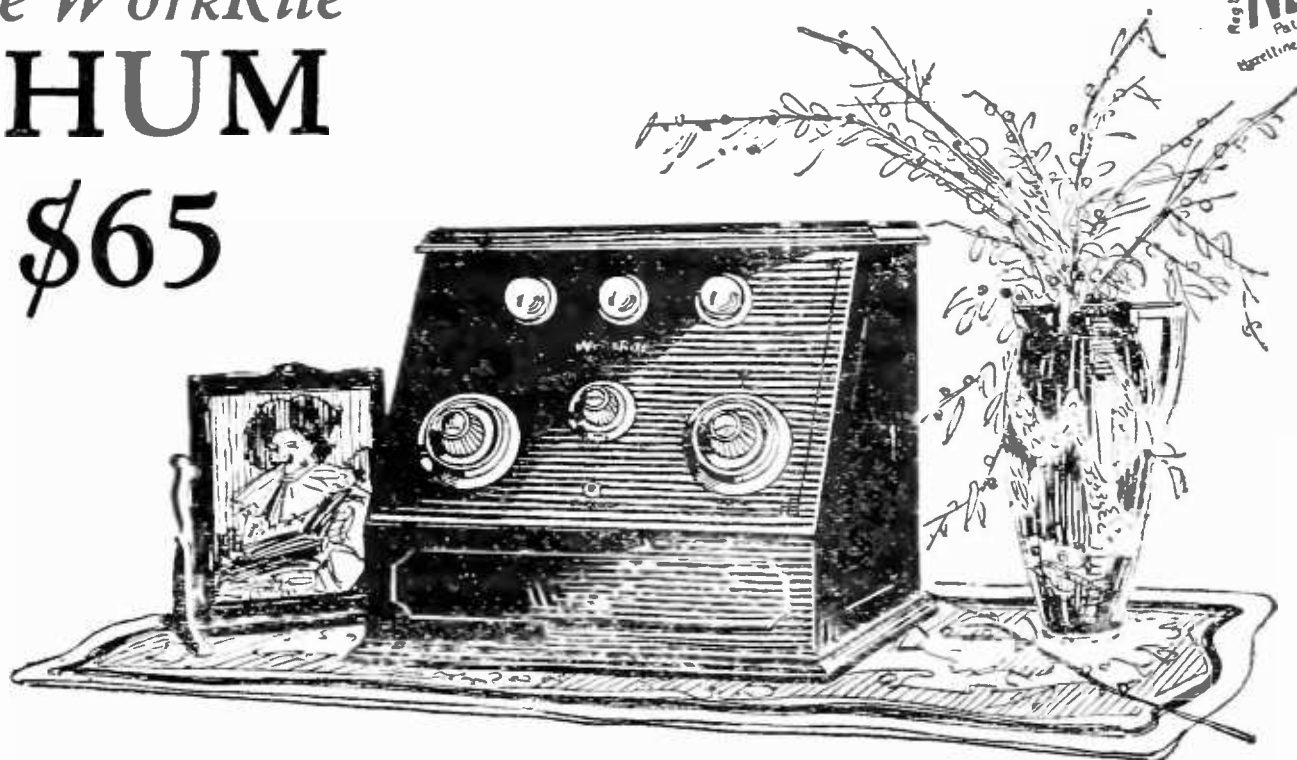

Reg. U. S. Pat. Off. Licensed by Independent Radio Manufacturers, Inc. NEUTRODYNE Pat. March 27 1923 and April 1, 1924. Reg. U. S. Pat. Off. Other Patents Nos. 1,450,993 and 1,492,220. Other Patents Pending.

A 3-Tube Neutrodyne That Out-performs Most 4-Tube Sets

HERE'S a brand new 3-tube reflexed Neutrodyne—one that sells for a remarkably low price. You have never seen a 4-tube set—even one that costs many dollars more—that could beat it.

The WorkRite Chum has a remarkable range. Distant stations—fully a thousand miles away—come in clearly and distinctly on the loud speaker. Under favorable conditions the Chum will cover a much larger area—and without whistles, howls, or distortion to spoil your fun.

It has selectivity, too. Tunes out local stations and brings in others clearly and sweetly as can be.

This beautifully built set is self-contained. There is space in the handsome dark mahogany cabinet for both A and B dry batteries. It works with any kind of an aerial—outdoor or indoor—and is always ready for instant use—any time or any place.

You must hear the Chum or any of the other famous WorkRite sets to appreciate real radio reception. Sit at the dials yourself. Get the real thrill of radio from WorkRite. Any WorkRite dealer will gladly let you demonstrate any of these famous sets to your own satisfaction. If the dealer you visit hasn't WorkRite in stock, send us the coupon to-day for complete information.

THE WORKRITE MANUFACTURING COMPANY
1810 EAST 30TH STREET CLEVELAND, OHIO

Branches: Chicago, 536 Lake Shore Drive; Los Angeles, 239 South Los Angeles Street

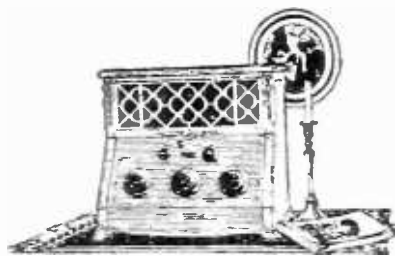

WORKRITE RADIO KING
A 5-tube Neutrodyne Set

Encased in brown mahogany cabinet with graceful sloping panel. Distortionless loud speaker built into cabinet behind handsome grille. WorkRite Air Master is almost identical with Radio King except it has no loud speaker.

Prices:

Radio King, without accessories \$170
Air Master, without accessories \$120

WORKRITE ARISTOCRAT
A 5-tube Neutrodyne Set

In this beautiful mahogany console, the loud speaker is placed on one side and compartment for A and B batteries on other side. All connections made inside with cable and plug. A set unsurpassed in any respect.
Price, without accessories . . . \$350



Send Coupon for FREE
Rotogravure Booklet

WORKRITE ★

SUPER NEUTRODYNE RADIO SETS

The WorkRite Mfg. Co.
1810 East 30th Street Cleveland, Ohio

Please send me FREE a copy of the Rotogravure booklet which describes WorkRite.

Name

Address

City State

★ Tested and approved by RADIO BROADCAST ★

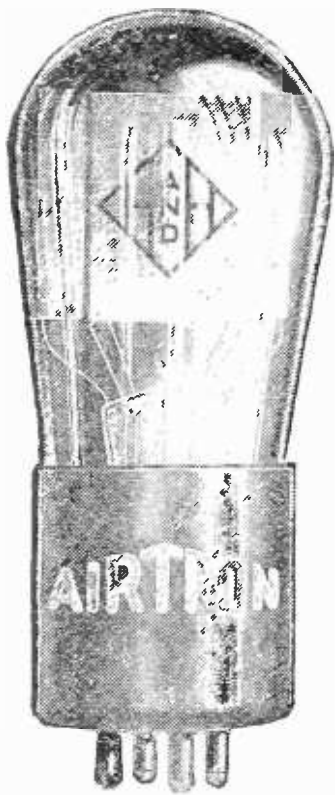

WHY AIRTRONS MULTIPLY RADIO ENJOYMENT

You will discover a new thrill and enjoyment from your radio set when you use Airtron Tubes.

Built with exactness and precision, with every effort bent toward greatest efficiency, the Airtron provides the most volume consistent with absolute purity of tone. In stamina, in clarity and sensitiveness, Airtrons will outperform any tube at anything near its price. Highly endorsed by radio experts.

Type 200-6 Volt-1 Amp. Det.
Type 201A-5 Volt-25 Amp. Det. & Ampl.

Type 12-1½ Volt-25 Amp. Det. & Ampl.
Type 199-¾ Volt-.06 Amp. Det. & Ampl.

List Price \$4.00

Fully Guaranteed

Sold by all dealers. or shipped C. O. D. direct by parcel post. Mention type when ordering.

H. & H. RADIO CO., Dept. 109, 514 Clinton Avenue, Newark, N. J.

DEALERS
Write for discounts

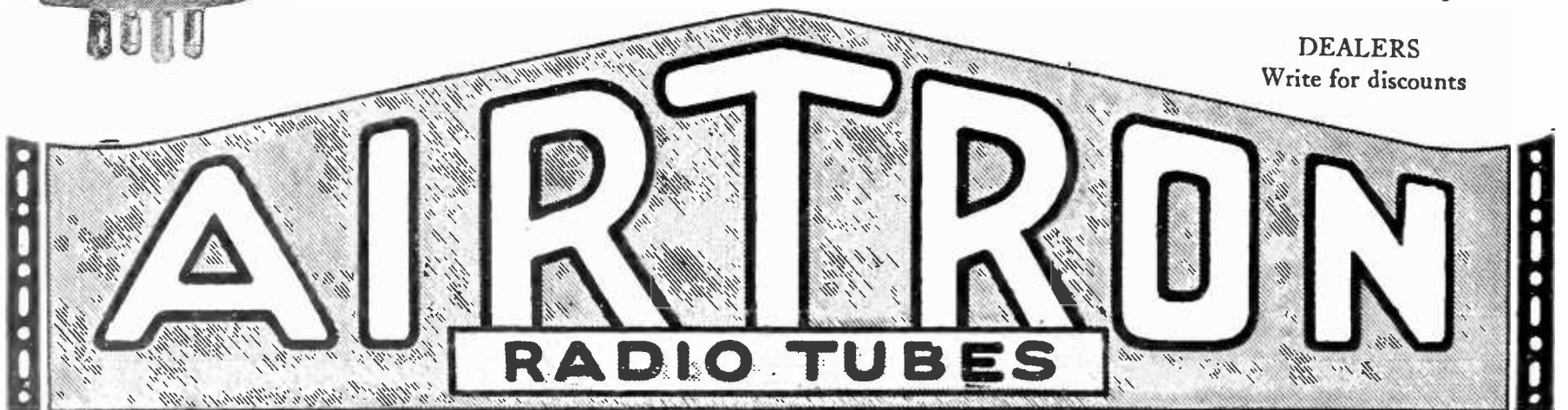

Building Better Service into RADIO PARTS

Aside from recognized radio uses in which no other metals can be substituted, COPPER and its alloys help you to make good radio sets *better* sets.

For instance, binding posts are superior posts, and battery nuts give best service and satisfaction when made of dependable free-cutting BRASS rod. *And—*

★ their speedier production makes labor costs lower.

COPPER & BRASS
RESEARCH ASSOCIATION
25 Broadway . . . New York

★ EBY BINDING POSTS

Twenty-five Different Engraved Tops *They Don't Lose Their Heads*



H. H. EBY MFG. CO.
Philadelphia



The Andrews ★ Deresnadyne Radio Receiving Set

combines tone quality and selectivity with distance and volume.
Price \$150 without accessories.
Write for literature.

ANDREWS RADIO CO.
327 S. LaSalle St., Chicago

★ Tested and approved by RADIO BROADCAST ★

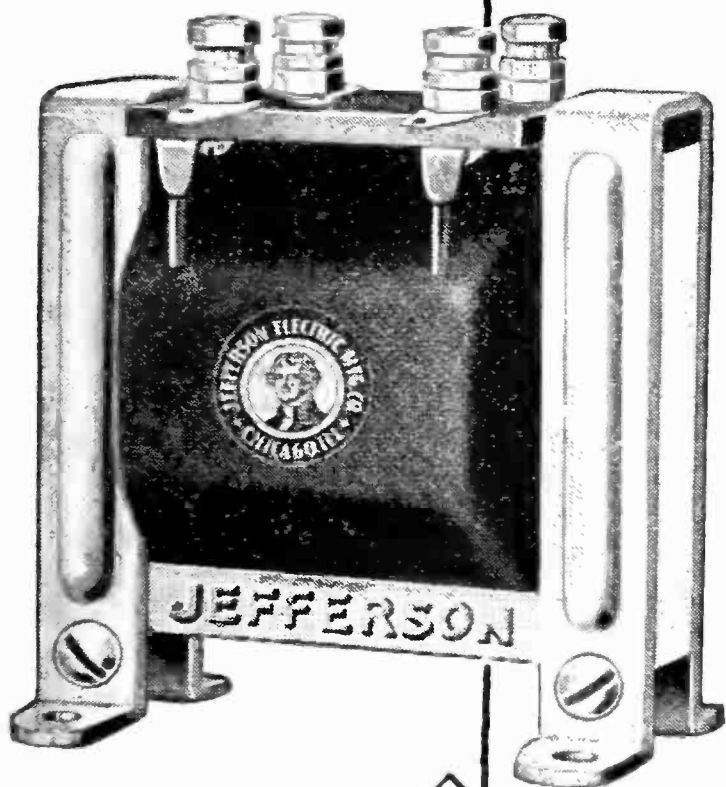

David Grimes' Choice

THE new Grimes 3XP Inverse Duplex circuit has established a new standard for reflex circuits and incidentally for radio reception. In developing this unusual receiver David Grimes tested each piece of apparatus as to its ability to function properly. It is significant that he chose

Jefferson Transformers

It's just one more instance of Jefferson superiority demonstrated by comparison. Jeffersons are everything that the radio transformer should be to make your loud speaker a true musical instrument.

David Grimes is only one of many radio authorities the world over who realize that better results are reached through Jefferson performance.

Built by a concern with over 20 years experience in the manufacture of high grade transformers. Jefferson Transformers meet matched construction specifications.

Sold through better dealers and distributors.

Jefferson Electric Mfg. Co.
442 S. Green St. Chicago, Ill.

MANUFACTURERS OF

- | | |
|----------------------------|-------------------------------------|
| Radio Transformers | Jump Spark—Make and |
| Bell Ringing Transformers | Break Coils |
| Sign Lighting Transformers | Testing Instruments |
| Automobile Ignition Coils | Toy Transformers |
| Auto Transformers | Furnace and Oil Burner Transformers |
| | Oil Burner Ignition Coils |

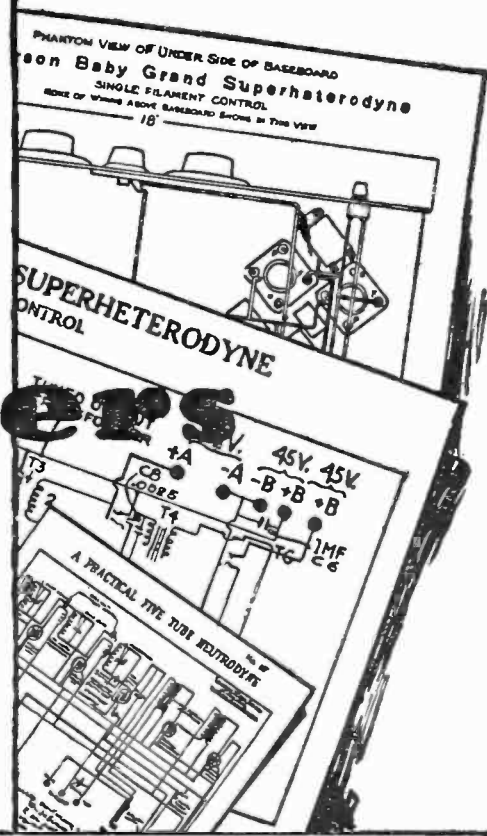

Send for these hookups

Included among the circuits for which we will send you complete working drawings are the Grimes 3XP Inverse Duplex, The Jefferson Baby Grand six tube Superheterodyne, and the Jefferson eight tube Superheterodyne. Any of these will be sent upon receipt of five cents in stamps to cover postage.

★ Tested and approved by RADIO BROADCAST ★

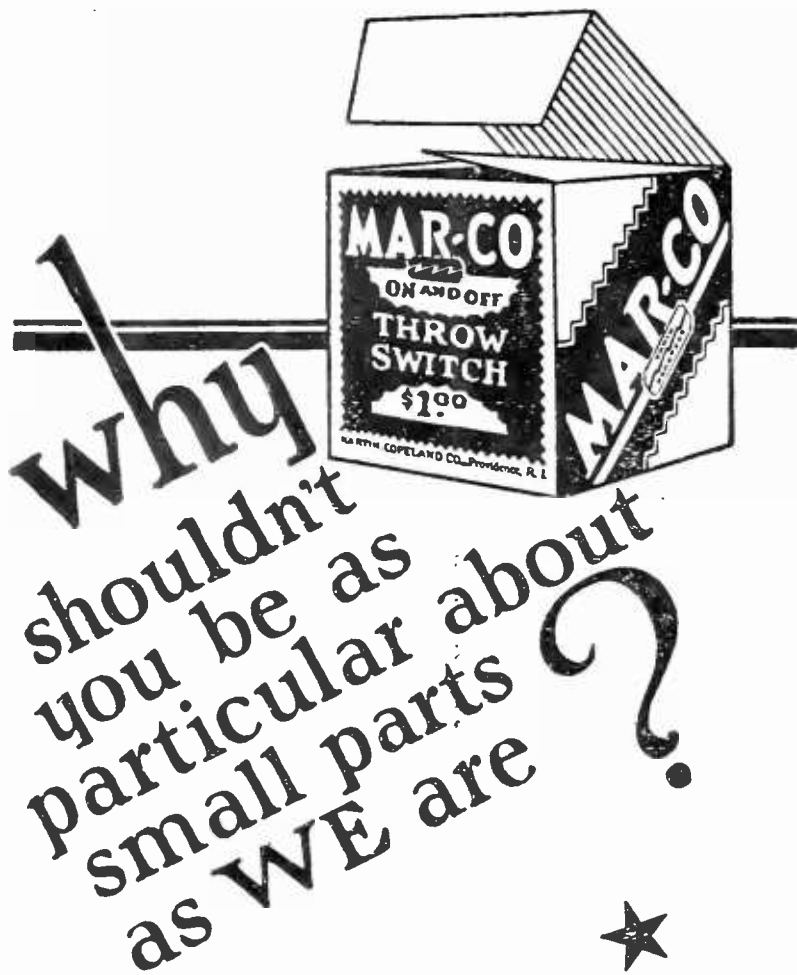

★
YOU USE THEM.

YOU DEPEND on them to *help* your larger instruments.

YOU EXPECT small parts to *pre-*serve the energy that reaches your set.

So why shouldn't YOU be as particular about their quality as WE are?

WE think no accessory too unimportant to build as carefully as we make fine optical instruments. All the craftsmanship we have developed in 44 years of precision work, we put into every MAR-CO small radio part.

Then we put them into the unmistakable MAR-CO packages, so that if you are as particular as we are, you can easily get the "leak-proof" service we build into them.

Simply say "MAR-CO" . . . and insist on seeing the MAR-CO package . . . when you want plugs, jacks, switches, grid-leaks, vernier condensers and other small parts.

MAR-CO
RADIO PRODUCTS

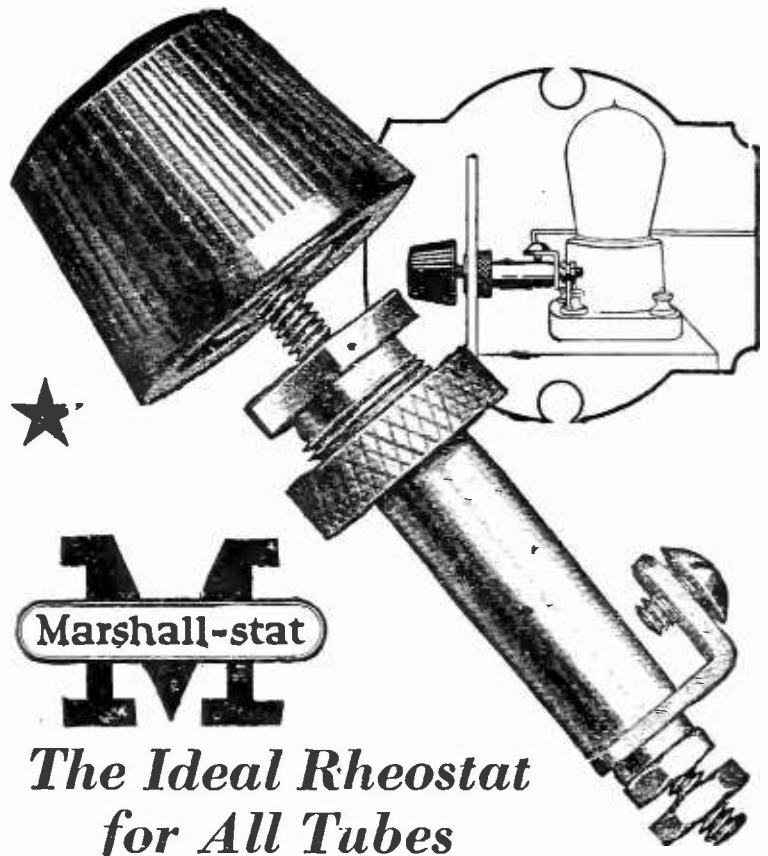

★
Marshall-stat

*The Ideal Rheostat
for All Tubes*

The Marshall-stat provides a means of obtaining any desired tube adjustment with absolute precision. The Marshall-stat varies the resistance, not step by step, but smoothly, continuously, and uninterruptedly from zero to maximum.

The Marshall-stat provides vernier precision throughout its entire range. Yet there is only one knob to manipulate—no double adjustment to make.

Besides its precision and ease of operation, the Marshall-stat requires only one hole in the panel, has only two terminals, can be

used with any tube or combination of tubes, and is so scientifically constructed that breakage of the especially-treated Marshall discs is impossible. Compact—

Note full size cut above. Can be fitted anywhere. Price \$1.75.



MARSHALL ELECTRIC COMPANY

3233 Locust Blvd., St. Louis, Mo.

Send for Old Man Ohm's descriptive folder on the Marshall-stat.

**Best for
Reflex**

and Crystal Sets ★
FRESHMAN

Double Adjustable
Crystal Detector

No more searching for the sensitive spot. —Merely turn the knob as you would a dial.

For base or panel mounting, complete with Freshman Super - Crystal

\$1.50

At your dealer's, otherwise send purchase price and you will be supplied postpaid.

CHAS. FRESHMAN CO., Inc.
106-7th Avenue, New York

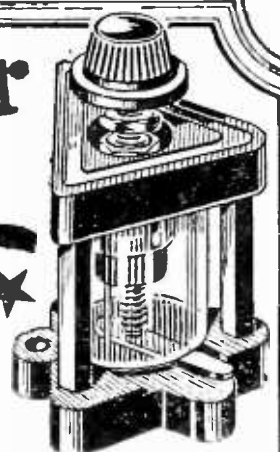

★ Tested and approved by RADIO BROADCAST ★

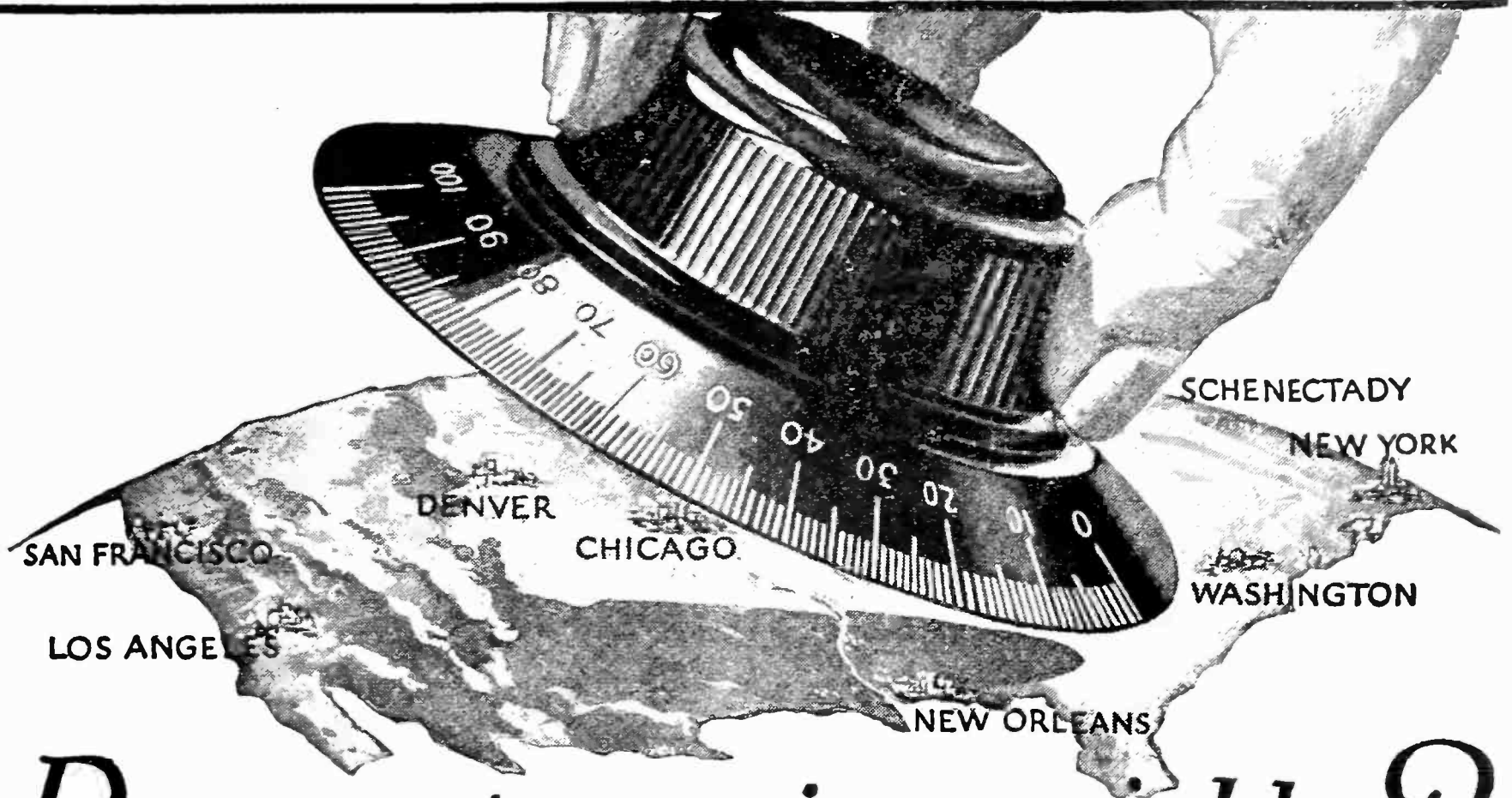

Do you tune-in quickly?

What a difference a good dial makes

ENJOY the pleasure and comfort of tuning in with greater ease and speed than ever before. Use Na-Ald Super De Luxe Dials and experience real dial satisfaction.

Station after station can be tuned in quickly and comfortably. Even if you tune in over and over again, searching for distant stations until late into the evening, you will experience no eyestrain nor finger-cramps when you turn the big generous-sized knob. It fits your fingers naturally.

It took engineers and optical experts months of careful study to perfect the scientific design of Na-Ald Dials. Stop Watch tests developed the best possible position of numbers, and lengths, spacing and width of lines.

You can obtain Na-Ald Dials at radio, electrical and hardware stores. Use them not only in the set you build but also install them in the set you buy, if not already adopted by the manufacturer. Super-De Luxe 75c; other sizes 35c, and 50c.

Send for free copy of radio booklet—"What to Build," showing a number of the best tested and selected circuits.

ALDEN MANUFACTURING COMPANY

Also makers of the famous Na-Ald Sockets
 Dept. B-3 Springfield, Mass.

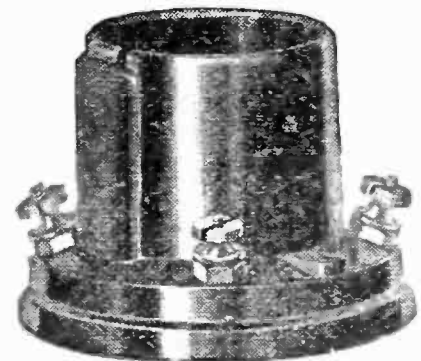

Na-Ald also manufactures a complete line of Bakelite Sockets for all tubes. De Luxe with special clean-easy feature, 75c; others 35c, 50c, 75c.

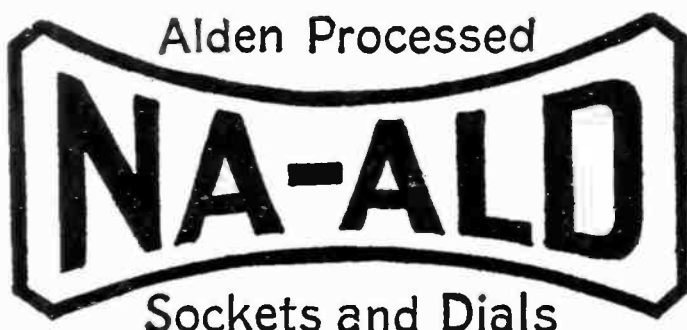

ALDEN MANUFACTURING COMPANY
 Dept. B-3, Willow Street,
 Springfield, Mass.

Please send free copy of booklet "What to Build," showing tested and selected circuits.

Name.....

Address.....

City..... State.....

★ Tested and approved by RADIO BROADCAST ★

New Adventures of **BURGESS RADIO BATTERIES**

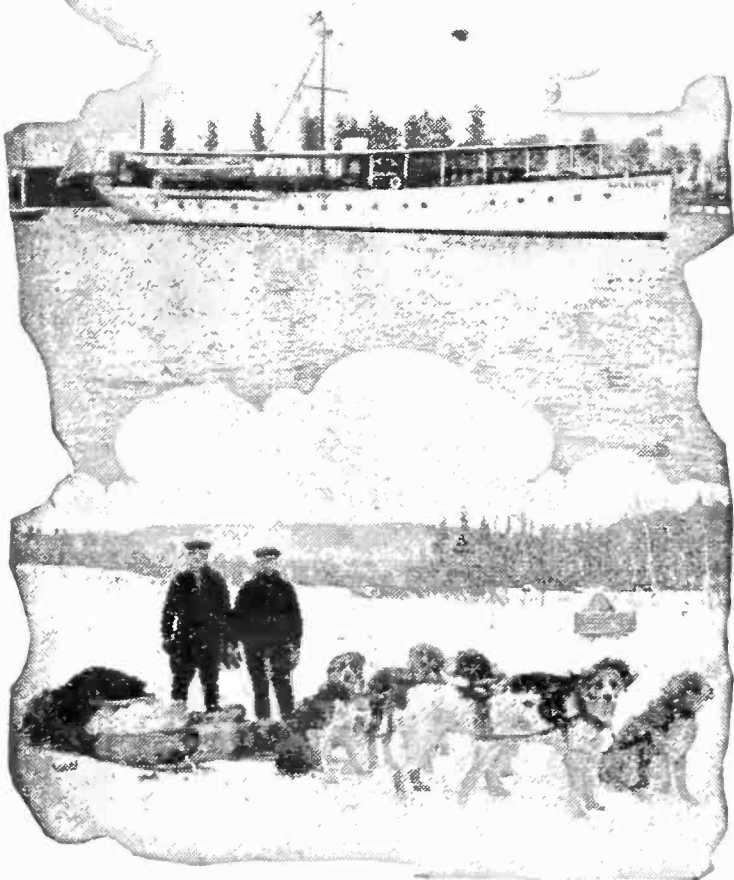

(Above)—They Roamed the World in the Speejack's Radio Room—U&U Photo
(Below)—Dog Sleds Carry Them to the Arctic Outposts of Civilization

You're fortunate—you average buyer of radio equipment. For when you are in need of new batteries you can phone or walk a few blocks for fresh ones to replace those in your receiver. Not so fortunate are those who wander across the world or spend their lives in the lonely outposts on the frontiers of civilization.

To them the correct selection of dependable receiving equipment is vital. For to be deprived of the use of their radio set is a dire catastrophe, and results in complete isolation from the world outside.

Those who *must* receive absolute, unflinching service over longer periods always buy Burgess "A," "B" and "C" Radio Batteries.

"Ask Any Radio Engineer" ★

BURGESS BATTERY COMPANY
Engineers DRY BATTERIES Manufacturers
Flashlight • Radio • Ignition • Telephone
General Sales Office: Harris Trust Bldg., Chicago
Laboratories and Works: Madison, Wisc.
In Canada: Niagara Falls and Winnipeg

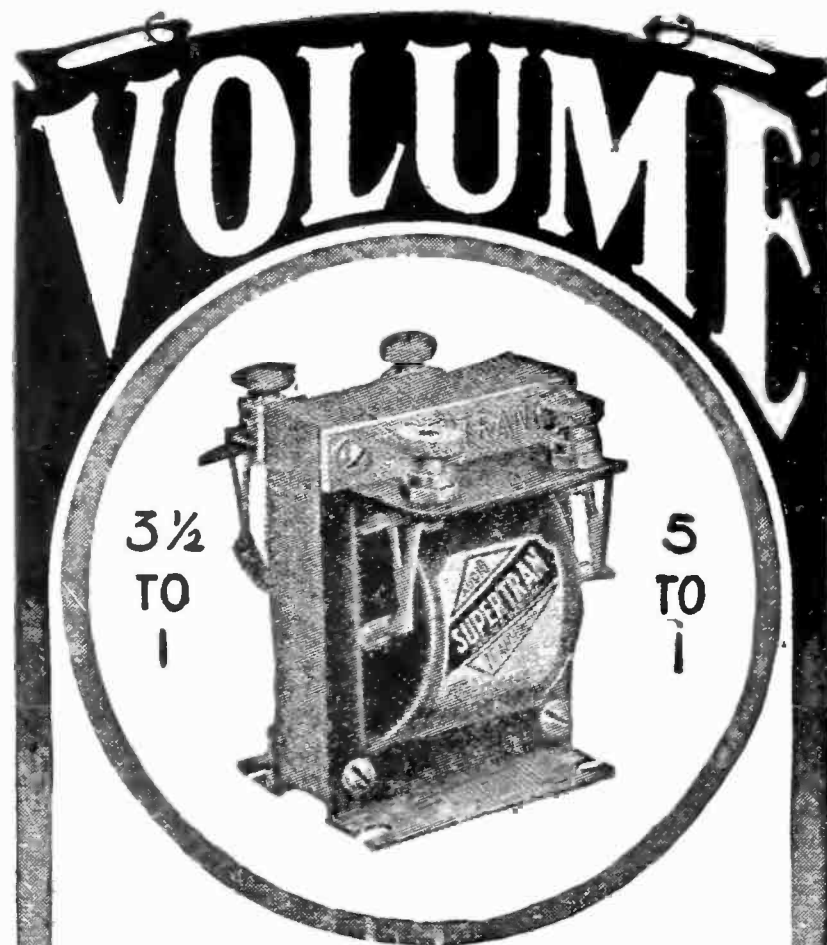

IF YOU want volume without distortion use Supertran Audio Transformers. They are shielded assuring absolute protection against damage to the coil while mounting.

\$6 AT ALL DEALERS ★

Distributed by

- Philip Chandler & Co., Boston, Mass.
- L. W. Cleveland & Co., Portland, Maine
- Gray Sales Co., Philadelphia, Pa.
- Waite Auto Supply Co., Providence, R. I.
- The Beckley-Ralston Co., Chicago, Ill.
- Coast Radio Supply Co., San Francisco
- Radio Ltd., Montreal, Canada

FORD MICA COMPANY, INC.
33 E. 8th Street New York

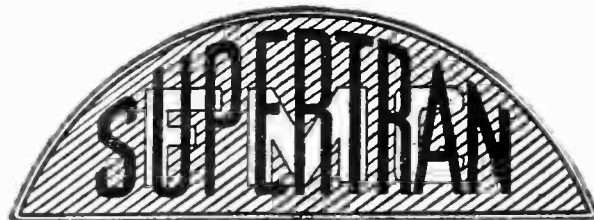

REGISTERED U.S. PATENT OFFICE

AUDIO TRANSFORMER

FAHNESTOCK CLIPS

The Perfect Radio Connectors—are used by manufacturers of standard sets and parts—and makers of wet batteries and exclusive on Eveready Dry Batteries.



Their *Sure Patented Grip* is recognized universally by enthusiastic users.

FAHNESTOCK ELECTRIC CO. Long Island City

★ Tested and approved by RADIO BROADCAST ★

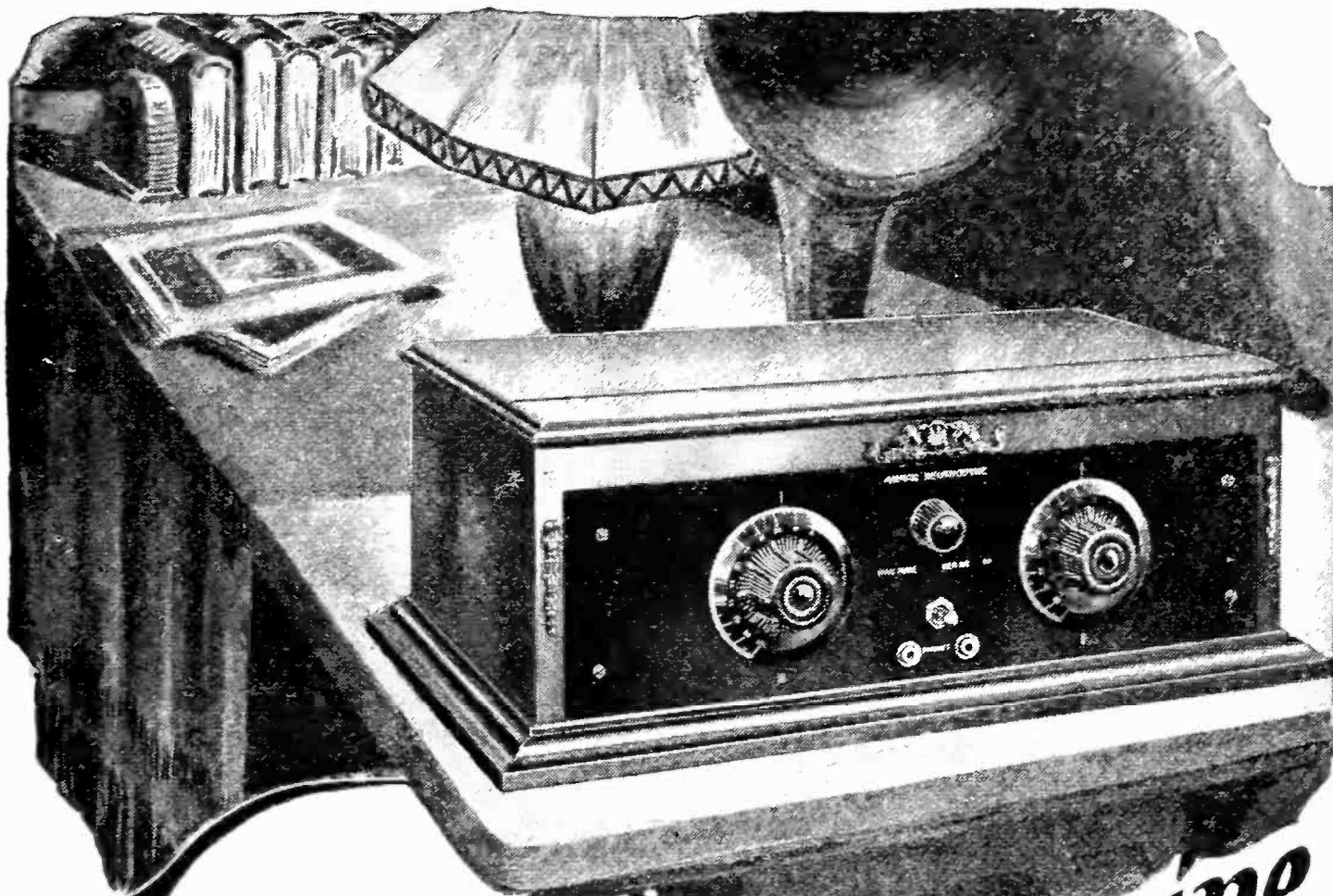

Hours of Delight

THIS beautiful, compact receiver will do EVERYTHING that can be expected from a much higher-priced set. Add to this, the fact it is a GENUINE NEUTRODYNE and you have the reason for its tremendous popularity.

Wonderfully clear tone, volume and power—delivered by FIVE tubes—controlled by only TWO adjustments—and manufactured by a Corporation with 10 YEARS' EXPERIENCE IN THE RADIO INDUSTRY.

Ask your dealer for a demonstration and do not be satisfied with something "just as good" until you see or hear this AMRAD.

Five features of this delightful, and technically correct Set are detailed in Folder 520 sent on request. Where may we mail it?

*A Genuine
Licensed 5-Tube
NEUTRODYNE*

Only

\$85

AMRAD NEUTRODYNE

"The Voice of the Air"



AMERICAN RADIO AND RESEARCH CORPORATION

Dept. B

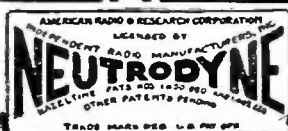

Medford Hillside, Mass.

★ Tested and approved by RADIO BROADCAST ★

WINDING MACHINES

FOR

Loud Speaker & Head-Set Coils

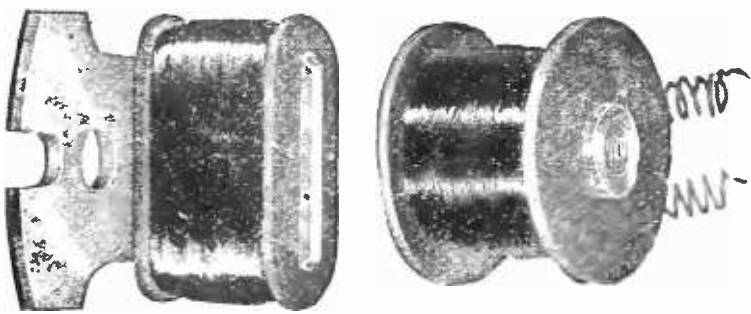

1. High Production Rate.
2. Labor Costs Reduced to a Minimum.
3. Accurately Wound Coils of Uniform Resistance.

THESE three greatly to be desired features are assured to users of the No. 102 Universal coil winding machine.

Manufacturers of loud speaker, telephone receiver, and other form-wound coils of fine wire, both in this country and abroad, are finding this multi-spindle winder indispensable for their work.

Requests for quotations and production estimates on your coil winding requirements will have the prompt and careful attention of our engineers.

UNIVERSAL WINDING COMPANY

Manufacturers of coil winding equipment covering practically every phase of the electrical industry

MAIN OFFICE: 95 South Street
Boston, Mass.

PLANT OFFICE: P.O. Box 1513
Providence, R. I.



MURDOCK PHONES

are backed by 20 years of successful experience. There are over 1,000,000 in use to-day. Murdocks are famous for distinct reproduction and for their light weight. With the Murdock Multiple Plug you can use from one to four phones at the same time.

WM. J. MURDOCK CO.
510 Washington Ave. Chelsea, Mass.

Free Booklet

Write for our free booklet "The Ears of Radio." It contains important data on head-phones.



MURDOCK RADIO PHONES

Standard since 1904

JUDGMENT OF THE STORM

By Roy Mason

A novel written from the photoplay of Ethel Styles Middleton which has been produced by the Palmer Photoplay Corporation. \$1.50.

Doubleday, Page & Co., Garden City, N. Y.



GILFILLAN NEUTRODYNE

Made in our three Radio factories with years of Radio experience behind them. Superior in range, Selectivity, Clarity and Volume, the Gilfillan Neutrodyne will be as good 10 years from now as today. Send for literature.

GILFILLAN BROS. INC.

★ 1815 W. 16th St., Los Angeles, Calif.
KANSAS CITY 2525 W. Penn Way
NEW YORK 225 W. 57th St.



★ Tested and approved by RADIO BROADCAST ★



Dear Jim:

So you've been bothered with battery noises. When a battery leaks electricity between plates or across cell-tops it sure kicks up a row.

This unbalances the current in the set and you get the same spitting and cracking noises as with partly run down batteries.

Willard Radio Batteries enable me to cut out these noises, and I can work on a full charge all the time, for Willards are rechargeable.

Their Threaded Rubber Insulation guards against leakage inside the battery, and their widely-spaced cells of glass with hard rubber tops say, "Halt," to current that tries to stray outside.

Willards are the only radio batteries insulated with Threaded Rubber. You'll find that they will make a tremendous difference in your set.

Your radio friend,

Sam.



WILLARD RADIO BATTERIES

Every radio fan should have WTAM's booklet, "Better Results from Radio." This booklet tells how to get better results from your set, how to

clear up battery noises, and gives many other interesting facts that you should know. Not a technical book. Written so everyone can understand.

Write to **WTAM** for this booklet
(The Voice of the Storage Battery)

WTAM is the Radio Research Laboratory and Broadcasting Station of the Willard Storage Battery Company, Cleveland, Ohio.

Its function consists of research which is being done to improve the quality of radio reception and the broadcasting of radio programs for your entertainment.



Mail me to WTAM. I'll bring you "Better Results."

..... Name

..... City and State

..... Street Address

R. B. 6

★ Tested and approved by RADIO BROADCAST ★

New Model "C"

U.S. and Foreign Patents

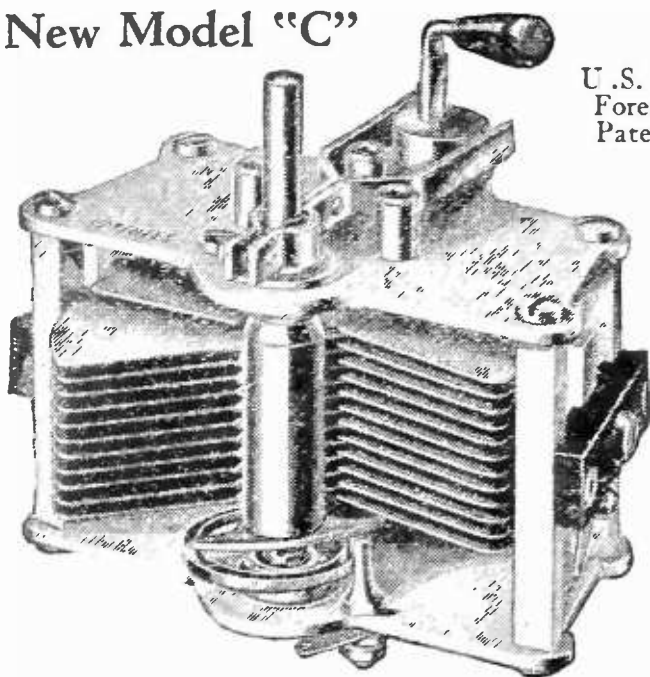

Keen as a Razor!

The sharpness of tuning you have vainly sought—the selectivity that was promised but never realized—the quality that should have come but didn't—they are yours when you tune your receiver with the new Model "C" Hammarlund Condensers.

When you find Hammarlund Condensers in the receiver you purchase, you will know that the manufacturer was determined to give you the best the radio world affords. Use only Hammarlunds in the receiver you build. All capacities; plain and vernier. Sold by the better radio dealers.

Write for descriptive folder.

9 points of Superiority

- 1—Soldered brass plates, chemically treated against corrosion; perfect alignment.
- 2—Stator plates specially shaped for easy tuning on low waves.
- 3—Adjustable ball-bearing rotor shaft, grounded through metal end-plates.
- 4—Soldered clock spring pigtail, with automatic stop.
- 5—Minimum dielectric; losses too small to be measured.
- 6—Rugged, compact construction; cannot warp.
- 7—Micrometer vernier moves all plates; no backlash.
- 8—Takes any size dial.
- 9—The product of 14 years' experience, making precision instruments.

HAMMARLUND MANUFACTURING CO.
424-438 West 33rd St., New York



Power "B" Supply from your light circuit

See page 268 December Radio Broadcast

Assemble your own power unit easily and quickly.

results equal to any power unit
Kit of Finished Parts Ready to Wire \$19.75

Kit contains—

Power transformer—50 Henry choke—4 Mf condensers—Detector & Amplifier variable voltage controls—induction shielding metal cabinet.

(Parts sold separately if desired.)

Radio Corp. Super Het. style loops \$10.00

Get details of new Hi-Power Super-Heterodyne—The Knock-out Super.

PARTS FOR ULTRADYNE — TROPADYNE — OR ANY SUPER-HETERODYNE CIRCUIT

1716 style long wave transformers \$5.75

Radio Freq. Iron and Long Wave windings to your specifications

OUR KNOCK-OUT AUDIO KIT GIVES IDEAL RESULTS

Aeriola style space wound low loss 2 rotor unit \$5.90
Gov't. BB-4 Edison batteries for 199's. A few at \$6.85

Our products embody high class material and workmanship

Dealers—get our new list

A special department takes care of Radio receivers and rebuilding

Quality Radio Shop
Richmond Indiana

THE FRENCH BINDERS

French binding—in America

Country Life Press Garden City, N. Y.

Radio and Electrical Mailing Lists

15,369 Radio Dealers Retail.....	per M.	\$7.50
1,670 Radio Mfrs.....	per list	15.00
2,321 Radio Supply Jobbers.....	per list	20.00
402 Radio Mfrs. complete sets.....	per list	5.00
16,000 Electrical Supply Dealers.....	per M.	7.50
610 Electrical Supply Dealers (who)....	per list	8.50

Can furnish all other Radio and Electrical Lists and all other classifications. Ask for General Price List and Red Book.

A. F. WILLIAMS, Mgr., List Dept.
Trade Circular Addressing Co.

168 W. Adams Street Chicago, Ill.

Established 1880

M I C R O - S E L E C T I V E T U N I N G C O N T R O L

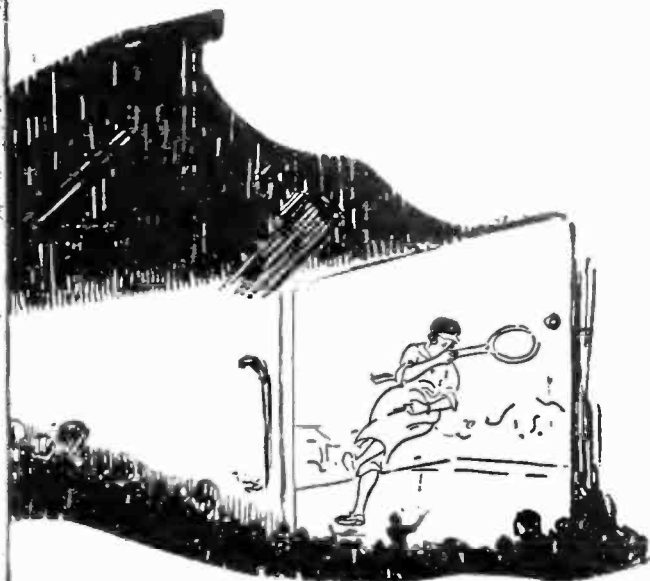
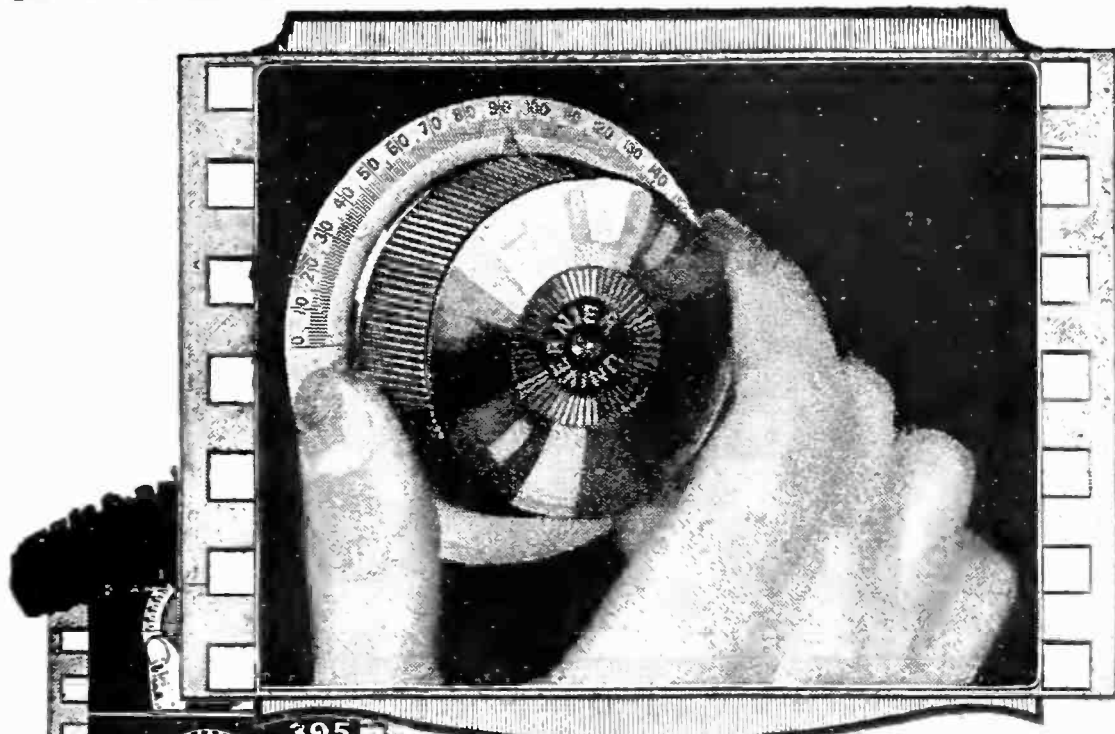

Want more stations?
"SLOW-MOTION" Tuning
will get them for you!

REMEMBER how the "slow-motion" picture helped you see details that were unnoticed in the usual running? In a similar way the "slow-motion" (12-to-1 ratio) of the UNIVERNIER helps you find dozens of stations that are missed if "searching" is done with the usual coarse adjustment (as you are compelled to do with many so-called vernier dials which merely duplicate the action of the obsolete vernier condenser). With its continuous "slow-motion", the UNIVERNIER *first* finds the station you want — *then* clears it up. That's why it's such a record-breaker for locating those hard-to-get distant stations and bringing them in so easily, quickly, clear and loud. Promise yourself a real surprise—replace your dials with UNIVERNIERS tonight!

A RECORD! Denver, Colorado hears 5N.O. Newcastle, England

Read this interesting letter from Mr. Walter E. Kessler, of Denver, Colorado:

Gentlemen: Using a three tube Superdyne set, I tuned in station 5N.O. Newcastle, England in the recent Trans-Atlantic Radio Tests.

Believe me they were hard to find and do not believe that I could have done it but for the "UNIVERNIERS" with which the set was equipped.

I thought that you might be interested to know that your UNIVERNIERS were used on a set that reached out this distance.

- 7 UNIVERNIER Features**
- 1—12-to-1 ratio—proven the *right* ratio.
 - 2—Entire range of set under continuous vernier control.
 - 3—Positive smooth action—no slipping or jerking.
 - 4—Sturdier mechanism.
 - 5—New attractive "dished" dial.
 - 6—Cannot destroy the accuracy of low-loss condenser bearings.
 - 7—Costs no more than a good dial.

Mahogany Knob and Gold-plated dial . . . **\$1.50**

Black Knob and Silver-plated dial **\$1.25**

At your dealer or sent postpaid on receipt of purchase price. [Please mention dealer's name.]

Jobbers and Dealers: Write for Discounts

THE WALBERT MANUFACTURING COMPANY
 927 Wrightwood Avenue
 Chicago, Illinois



WALBERT
UNIVERNIER

FREE!
 Send 2c stamp for FREE copy of UNIVERNIER LOG BOOK.

ALL WALBERT PARTS PROTECTED BY PATS. OR PATS. PEND., U. S. AND FOREIGN

★ Tested and approved by RADIO BROADCAST ★

Federal Factory Facts

THE plug is the key that unlocks the full possibilities of your receiver. No matter what you are getting off the air, you hear only what the plug lets through.

Buy a No. 15 Federal Plug for your radio phones or loud speaker if you want to know what your radio set can give you.

Buy a Federal Plug to-day—also take advantage of the other 130 standard radio parts sold under the same Federal iron-clad performance guarantee.

FEDERAL TELEPHONE MANUFACTURING CORPORATION

Buffalo, N. Y.

Boston New York Philadelphia
Pittsburgh Chicago

San Francisco

Bridgeburg, Canada



Federal

Standard RADIO Products



Look for this sign
FEDERAL
Standard RADIO Products

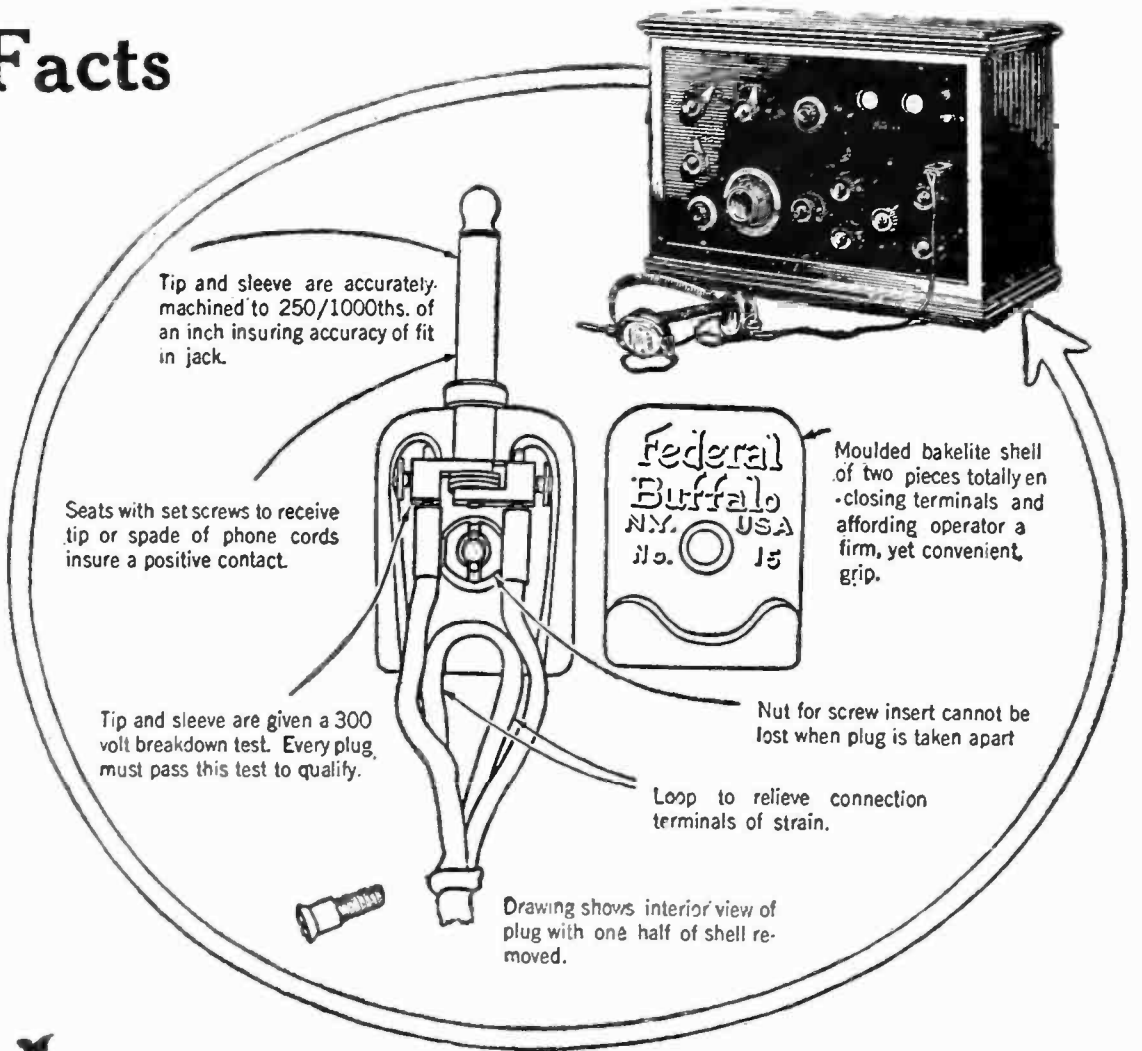

A NEW KIND OF RADIO PUBLICATION FREE



"Radio Dispatch" is FREE

There is no subscription, no obligation of any kind. "Radio Dispatch" is sent absolutely free to anyone interested in radio. Don't miss the next number. Mail the handy coupon to our nearest store to-day.

"Radio Dispatch" is more than a radio catalog. Every thirty days it appears in complete new form and brings you a careful review of the most important articles published in all radio magazines.

New parts and new circuits are all described frankly and fearlessly. You are told just how they operate, where to buy them and how much they cost.

In Radio Dispatch you will find all the things you want to know, everything that editorial policy will not permit other magazines to publish.

Here are a few examples of articles which have appeared in Radio Dispatch. All back numbers will be sent you without cost—and a new edition every month thereafter.

Complete description of the new Cockaday Reflex Super-Heterodyne. Why is it necessary to match your tubes? How to build a Three Stage Power Amplifier. The truth about the new cone-type loud speakers. How to build your own "B" Battery eliminator. The Roberts "Knock-out" Series. What's New in Radio.—and a dozen other up-to-the-minute developments in radio.

HAYNES-GRIFFIN RADIO SERVICE, Inc.
250 W. 49th St.
New York City
111 So. Clark St.
Chicago

HAYNES-GRIFFIN RADIO SERVICE, Inc.
Mail Order Departments
250 W. 49th St., N. Y. 111 S. Clark St., Chicago

Put me on your mailing list for "Radio Dispatch."

Name.....
Address.....

★ Tested and approved by RADIO BROADCAST ★

Handsome - Safe - Fast

GOLD SEAL HOMCHARGER

Radio's most popular Battery! Charger!

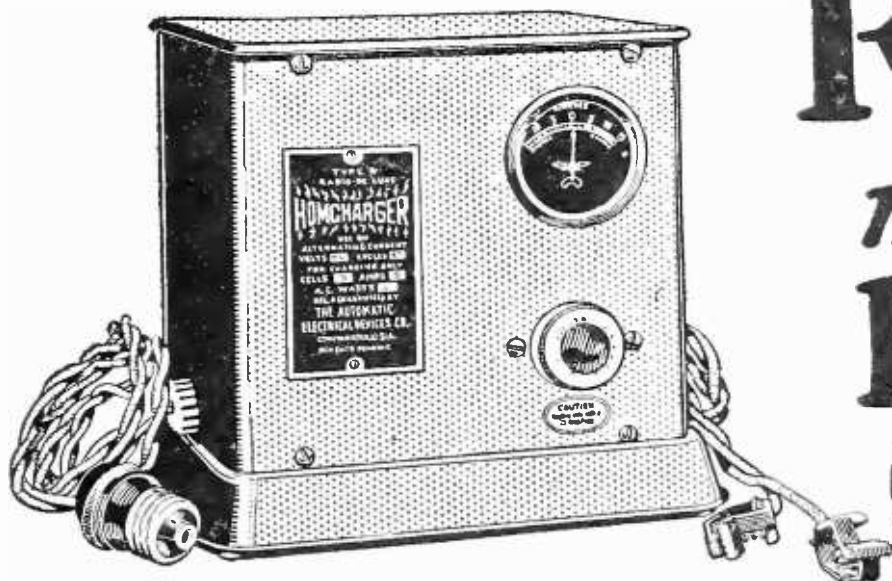

OVER 250,000 Radio fans have found the big capacity 5 ampere GOLD SEAL HOMCHARGER ideal for keeping their Radio batteries fully charged and operating at top efficiency. Connects to any lamp socket and charges all Radio "A" and "B" and Auto Storage Batteries over night for a nickle.

Simple, reliable, fool-proof. Can be operated by any one. Contains no bulbs, acids or fast wear-

ing carbon contacts. Only one moving part, replaceable for \$1.00 after thousands of hours' use.

Absolutely safe—no danger of shock or fire. Approved by Insurance Underwriters everywhere. Beautifully finished in mahogany and gold. May be used right in the finest living room. Price, \$18.50 complete for all currents.

fast!
—charges in one-third
the time required by
2 or 3 ampere chargers.

Sold by all good Radio dealers, or shipped charges prepaid upon receipt of price.

★ THE AUTOMATIC ELECTRICAL DEVICES CO.
128 W. THIRD STREET CINCINNATI, OHIO

Largest Manufacturers' vibrating rectifiers in the world

Free

Write for booklet, "The Secret of Distance and Volume in Radio," containing information on this subject and fully describing the GOLD SEAL HOMCHARGER.

Free



★ Tested and approved by RADIO BROADCAST ★

RADIO

holds a future for you



Radio Designing

The limitless field of radio—growing by leaps and bounds—daily opens up new opportunities for success. And here is your opportunity to qualify for a good position—with substantial pay—and a future.

STUDY RADIO AT HOME

You do not have to give up your present employment. The Radio Institute of America—the world's oldest radio school—with 7,000 graduates—now offers a *new and completely revised* HOME STUDY COURSE in radio that will prepare you to successfully pass the U. S. Government examination for a Commercial Radio License.

Radiola III Free with Course

An omnigraph, a buzzer set, up-to-date textbooks and *Radiola III with two tubes and Brandes Headset* come free with course—the best materials obtainable.

The Radio Corporation of America conducts the school. The largest radio companies give employment preference to our graduate because of their superior training. Mail coupon now for information.

Radio Institute of America

(Formerly Marconi Institute)

Established in 1909

328 Broadway, New York City

RADIO INSTITUTE OF AMERICA

328 Broadway, New York City

Please send me full information about your Home Study Course of radio instruction.

I am interested in the complete course including code instruction.

I am interested in the technical course without code instruction.

Name.....

Address.....



Burns

Loud Speaker

of Distinctive Beauty

Generous Proportions

NATURAL TONES WITH VOLUME

A Reproducer that Satisfies

Aluminum Sound Column. 14 inch pyralin bell. Convenient adjuster.

No. 205B Polished Black Flare \$22.50
No. 205D Mahogany Tinted Flare 25.00

Manufactured by

American Electric
COMPANY

State and 64th Sts.

Chicago

The Famous

BEL-CANTO

★ Loud Speakers

NOW at your DEALER

10" Bell—22" High . . \$10
15" Bell—29" High . . \$15
(Goose Neck)

If your dealer cannot supply you, write us and we will advise where to purchase one.

BEL-CANTO RADIO & TEL. EQUIPMENT CO., Inc.
872 Broadway, New York City Tel., Stuyvesant 1921

DeForest License



Honeycomb Coils

Back and Front Panel Mountings Plain or Geared—Genuine Bakelite

The Universal all-wave inductance—accepted as standard in regard to superior construction and electrical units of measurement. Ask your

'Old Timer' radio friend why sets using honeycomb coils are better; they give closer tuning, greater selectivity and range. No dead end losses, easy to operate. 16 sizes, mounted and unmounted. Interchangeable with all mountings. Be sure the set you buy or build has them.

Send 25c for Super Heterodyne, Radio Frequency and Honeycomb coil Circuits and Complete Catalogue. ★

Chas. A. Branston, Inc., Dept. 7, 815 Main St., Buffalo, N.Y.
In Canada—Chas. A. Branston, Ltd., Toronto

★ Tested and approved by RADIO BROADCAST ★

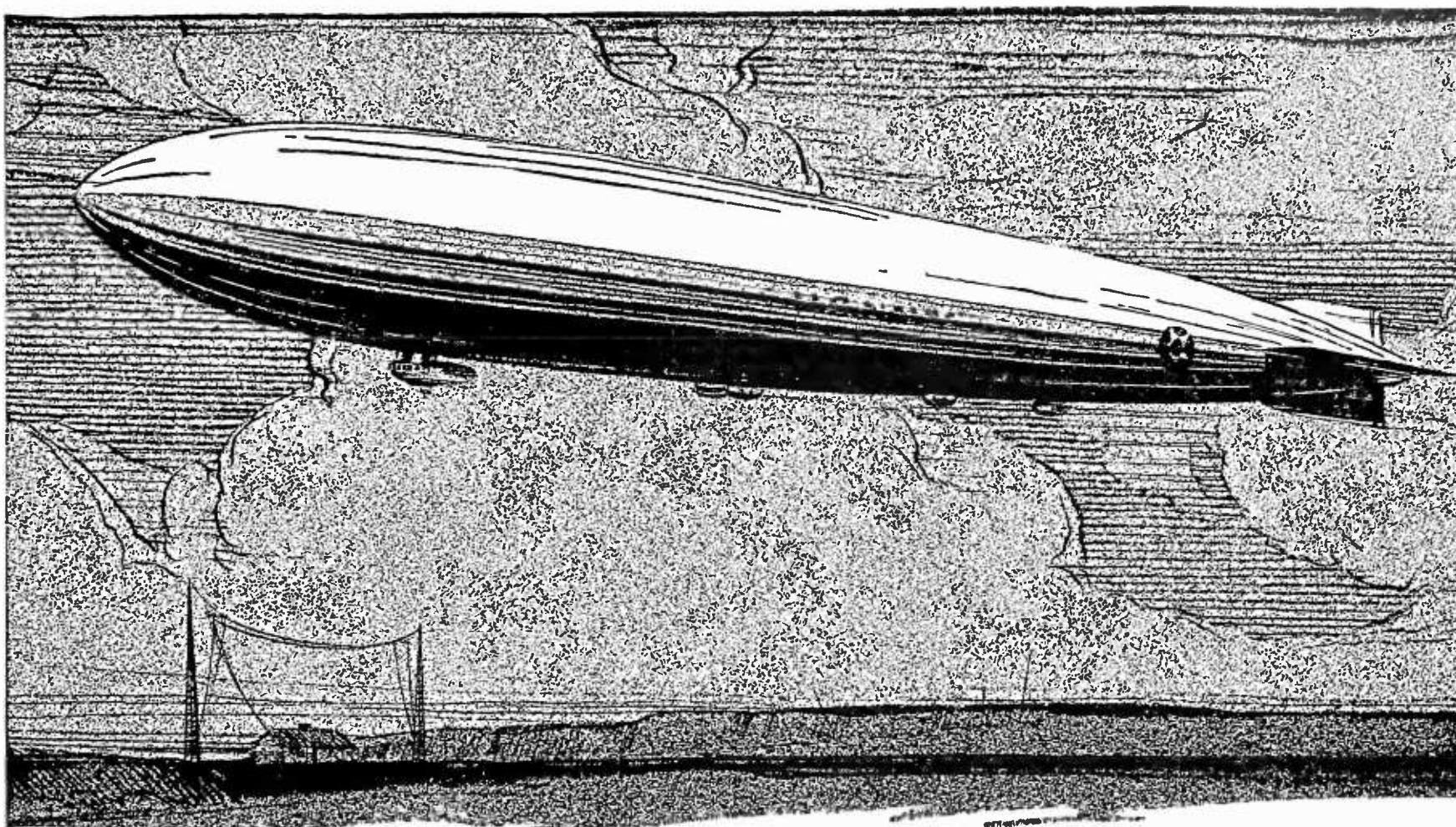

DUBILIER CONDENSERS

Important Links between the Shenandoah and Land!

Communication with land—under all conditions—at all times—this was the imperative need of the Shenandoah on its experimental flight across the continent. Impressed with this need, army and navy engineers equipped both transmitting and receiving sets with Dubilier mica condensers—not specially designed condensers but the regular standard product. Only complete confidence in the supreme reliability and efficiency of Dubilier condensers can explain their use in this important and daring adventure.

★ **Dubilier**
CONDENSER AND RADIO CORPORATION

★ Tested and approved by RADIO BROADCAST ★

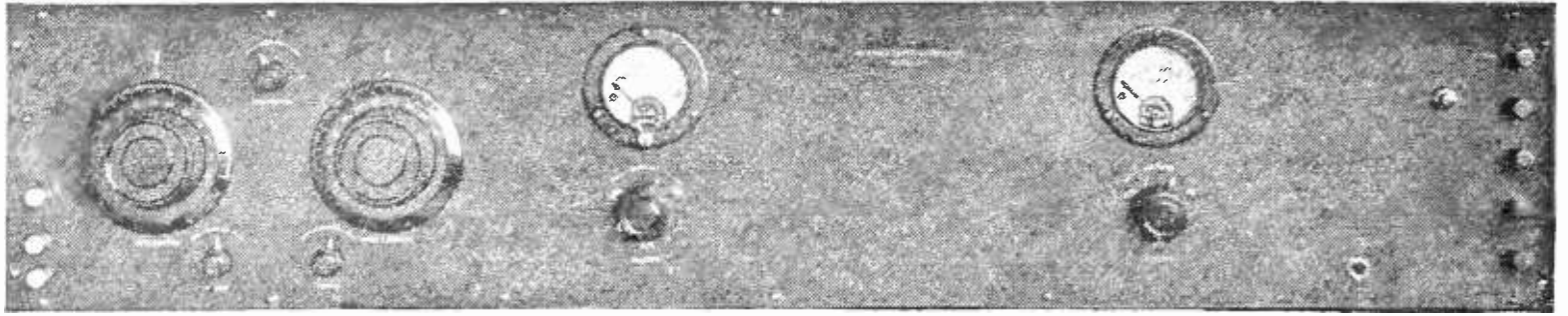

For any Circuit

Prompt shipment can be made on tested, standard apparatus of the following manufacture:

E. I. S., Inc.
General Radio
Ultradyn *Willard*
Sangamo Electric
Benjamin Electric
Allen Cardwell
Dubilier *Formica*
Weston *Magnavox*
Jewell *AmerTram*
Western Electric
Radio Corporation
Music Master *Acme*
CutlerHammer *Frost*
Federal *Kellogg*

Pressley Circuit
as described in
Poplar Radio. We
furnish parts as
specified.

Super-Heterodyne C-7

Model C-7 the Long Distance Concert Receiver
that Excelled in the recent Trans-Atlantic Tests

None of the so-called new "circuits" or modifications of standards approach the C-7 in efficiency—for long range, for high audibility, for selectivity, *seven tubes give the result of ten* because this model allows signals to be regenerated and heterodyned through radio frequency amplifier.

E. I. S. Model--All material we furnish is endorsed and recommended by the designers. ★

Using the finest apparatus and building to Naval standards, model C-7 has a telephone range of 3000 miles.

Norden-Hauck Price List Saves You Money

Free Information—Write for descriptive matter and price list. Our service is as near as your mail box. Special engraving to order.

Full Stock on Hand—We carry complete stocks of laboratory tested apparatus for immediate shipment.

Norden, Hauck & Co. Engineers - Office and Laboratories
1617 Chestnut St., Philadelphia

Protects Radio Tubes



You can protect tubes against destruction from short circuits for a few cents by installing the "Gem" Radio Fuse. Then when there's a "short," the fuse blows and the tubes aren't injured. Easily installed.

Sent postpaid for 60c with fuse block for attaching, if not at your dealers. Write for booklet.

CHICAGO FUSE MFG. CO.

1505 West 15th St., Chicago, Illinois

"GEM" RADIO FUSE

"ROBERTS SETS" "HANSCOM SUPER"

2-4 tube push pull and resistance coupled, built by us for this magazine as illustrated in past numbers are now available to the public—also six tube HANSCOM SUPER-HETERODYNE—THE REAL SUPER FOR DISTANCE.

Prices on Request.

ALL PARTS IN STOCK.

EXPERIMENTAL - RESEARCH - TEST - SERVICE

Mail Orders Solicited

SUPERS—ADJUSTED

Radio Research Laboratories

Schneider-Horneij, M. I. R. E.

154 Nassau Street

New York

If You Built Your Radio Set You Can Build This Cabinet



Cabinet has special groove arrangement on side, top, and bottom so that set can be easily removed and is held in a rigid position without screws which prevents warping.

All connections to A and B batteries are made in back of panel due to special construction which permits access to same.

Hinged shelf when lowered provides ample room for writing and when closed protects set from injury and makes cabinet dust-proof.

Lower compartment provides for A and B batteries and is large enough for miscellaneous radio equipment.

Plans provide for panel 7" high and any width desired and are accurate in every detail. Each piece of wood is numbered to correspond with assembly sheet which can readily be followed and understood by anyone whether he knows anything about cabinet work or not.

This cabinet retails for \$45.00 but can be made by anyone in his spare time for less than \$10. which is within the reach of every radio fan.

Mail your remittance by bank draft, money order, or personal check and receive these plans and complete instructions by return mail and start your cabinet at once.

WAL RADIO CABINET CO. ★

Fort Lee

New Jersey

★ Tested and approved by RADIO BROADCAST ★

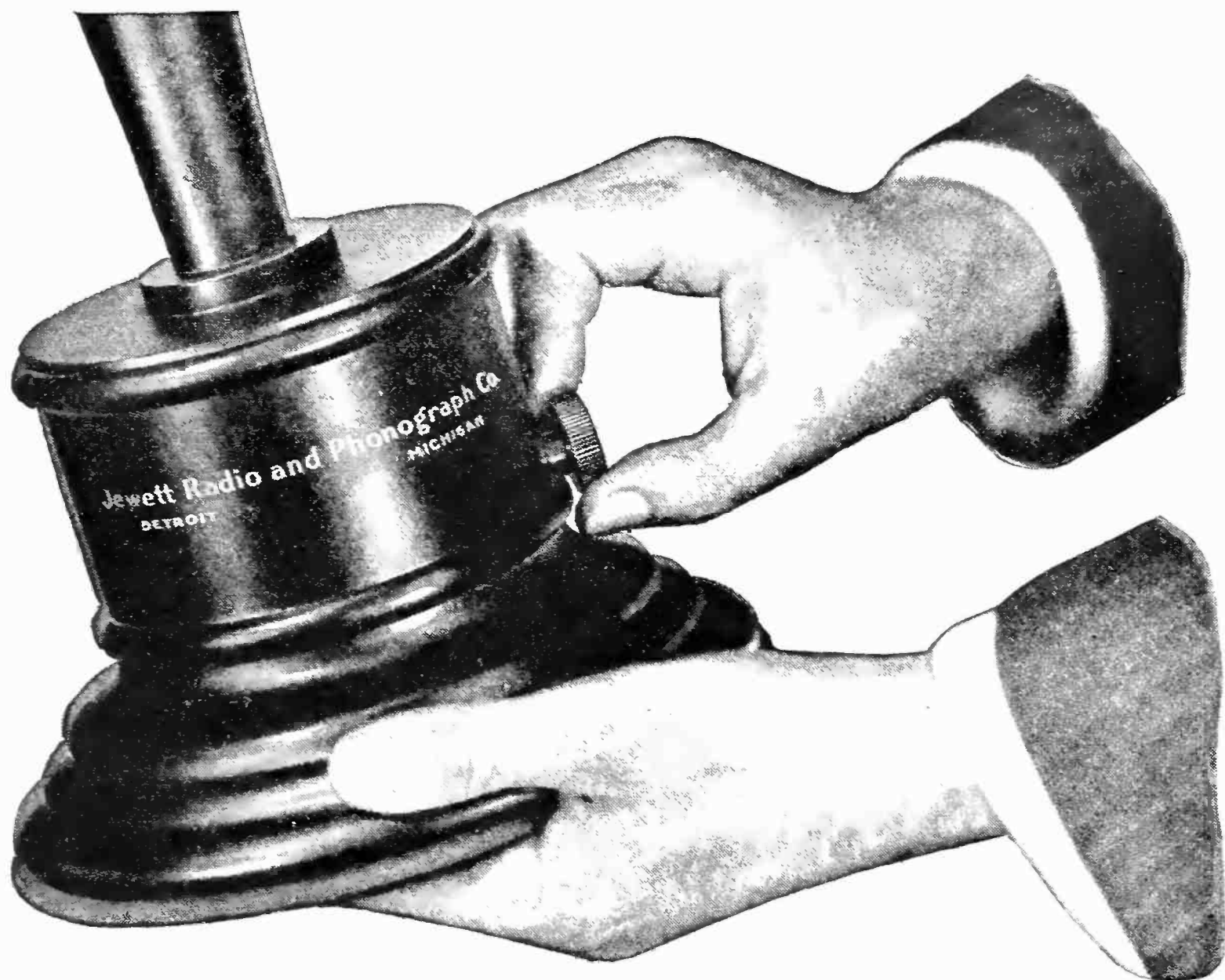

Controlled Volume

With a Radio set of only moderate ability, Superspeaker reproduction of nearby stations might often be stronger than you could possibly need.

But there is always the Superspeaker Volume Control. With it you can modify the heaviest message almost to a whisper. Yet it also puts at your command the greater power you need behind your set, as you reach out and sweep the ether for messages from far away.

This same Volume Control makes you independent of varying battery strength, and enables you to balance delicately every change in temperature or humidity.

Just hear The Superspeaker! Compare it, before you buy, with any other reproducing device, and learn the difference for yourself!



A high quality musical instrument handsomely finished in ebony gloss, standing 26 inches high and weighing more than five pounds. No extra batteries or coils. Nothing to wear out. Built complete by a manufacturer whose reputation, resources and ability are common knowledge throughout the industry.



JEWETT RADIO & PHONOGRAPH CO.
5672 Twelfth Street Detroit, Michigan



"THERE IS NO SUBSTITUTE FOR THE BEST"

The Superspeaker

Trademark Registered

★ Tested and approved by RADIO BROADCAST ★



The World is Yours with The New UNCLE SAM ★ Master Tuning COIL

THE
COIL
WITHOUT
LOSSES

DURING the recent international receiving tests, many owners of sets equipped with Uncle Sam Coils heard London, Madrid, Aberdeen, Scotland and other European stations. Don't confine yourself to the boundaries of your own country. Use Uncle Sam Coils and the world is yours.

- | | |
|--|--|
| 1—Wound on moulded hard rubber. | 3—Eliminates all adhesives. |
| 2—The only coil of its kind wound with Ambassador Litz wire. | 4—Increases volume 50% to 250%, also selectivity, over old type. |

LABORATORY TESTS PROVE CONCLUSIVELY THAT IT IS THE ONLY COIL WORTHY OF THE NAME LOW LOSS

FREE! Ask your dealer or send us four cents in stamps for wiring diagrams of circuits in which this remarkable coil can be used.

UNCLE SAM ELECTRIC COMPANY

219 E. Sixth Street

Plainfield, N. J.

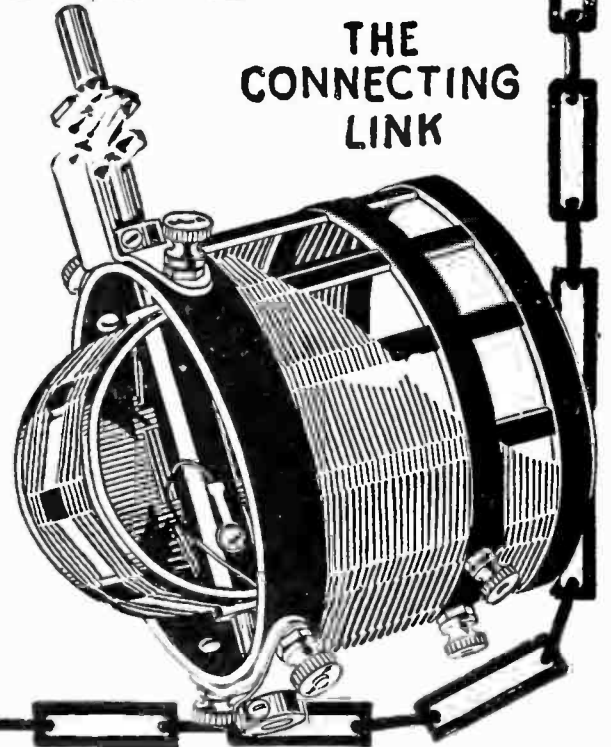

THE
CONNECTING
LINK

The Standard of the World



The base-type Freshman Variable Grid Leak

is the standard for those who build their own sets. It is the most compact and being entirely sealed it always remains unaffected by any climatic conditions.

Complete with either .00025 or .0005 Freshman Condenser— **\$1.00**
without condenser..... **.75**

At your dealer's, otherwise send purchase price and you will be supplied postpaid

Chas. Freshman Company, Inc.
106-7th Ave., New York

Rudyard Kipling's LAND AND SEA TALES FOR BOYS AND GIRLS

Over one hundred thousand copies of this book have been sold already in England. It is a perfect book for Boy Scouts and belongs on every child's bookshelf with *Rewards and Fairies* and *The Jungle Books*.

At bookstores, \$1.75.

Doubleday, Page & Co.

LEARN THE CODE AT HOME with the OMNIGRAPH

"Just Listen—The Omnigraph will do the teaching"

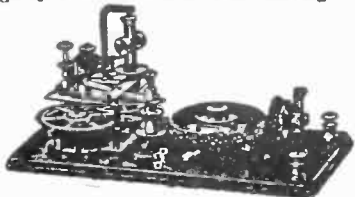

THE OMNIGRAPH Automatic Transmitter will teach you both the Wireless and Morse Codes—right in your own home—quickly, easily and inexpensively. Connected with Buzzer, Buzzer and Phone or to Sounder, it will send you unlimited messages. at any speed, from 5 to 50 words a minute.

THE OMNIGRAPH is not an experiment. For more than 15 years, it has been sold all over the world with a money back guarantee. The OMNIGRAPH is used by several Depts. of the U. S. Govt.—in fact, the Dept. of Commerce uses the OMNIGRAPH to test all applicants applying for a Radio license. The OMNIGRAPH has been successfully adopted by the leading Universities, Colleges and Radio Schools.

Send for FREE Catalogue describing three models. DO IT TO-DAY.

★ THE OMNIGRAPH MFG. CO., 16K Hudson St., New York City

If you own a Radio Phone set and don't know the code—you are missing most of the fun

★ Tested and approved by RADIO BROADCAST ★



Anti-capacity JACKS



Anti-capacity SWITCHES



Lower-Loss
VARIABLE
Vernier
CONDENSERS



Lower-Loss PHONE PLUGS



Lower-Loss
RHEOSTATS



Lower-Loss
SOCKETS

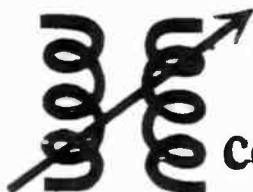

Lower-Loss
VARIO-COUPPLERS



Lower Loss
Variable GRID LEAKS



Lower
Loss
INDUCTANCE
SWITCHES

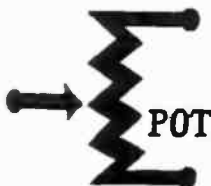

Lower-Loss
POTENTIOMETERS



Audio-Frequency
TRANSFORMERS

Ready!

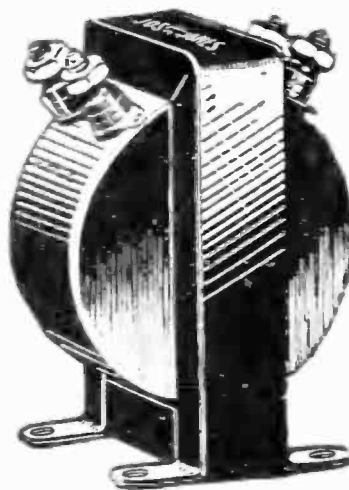

The Jones Transformer

Volume without distortion is assured by the use of the JOS. W. JONES Transformer. A low ratio audio frequency Transformer which always gives maximum value of signal intensity. May be used in both stages and with all tubes.

Throw away your soldering iron and build with JOS. W. JONES parts: Audio Frequency Transformers; Variable Vernier Condensers; Low Loss Variable Grid Leaks, Vario-couplers, Potentiometers, Inductance Switches, Phone Plugs, Sockets;—and *Anti-capacity* Jacks and Switches. Simple binding posts make all connections. And less drilling is required.

JOS. W. JONES

RADIO

TRADE MARK

“Improved” radio parts

JOS. W. JONES RADIO MFG. CO., INC.
Home Office, 40-42-44-46 W. 25th Street, New York

Branch Offices:
Philadelphia: 1011 Chestnut St. Chicago: Monadnock Bldg. Boston: 99 Bedford St.

★ Tested and approved by RADIO BROADCAST ★

Curve of WADE .005 mfd. Square Law Condenser showing Straight Line Wave-Length and Wide Tuning Range.

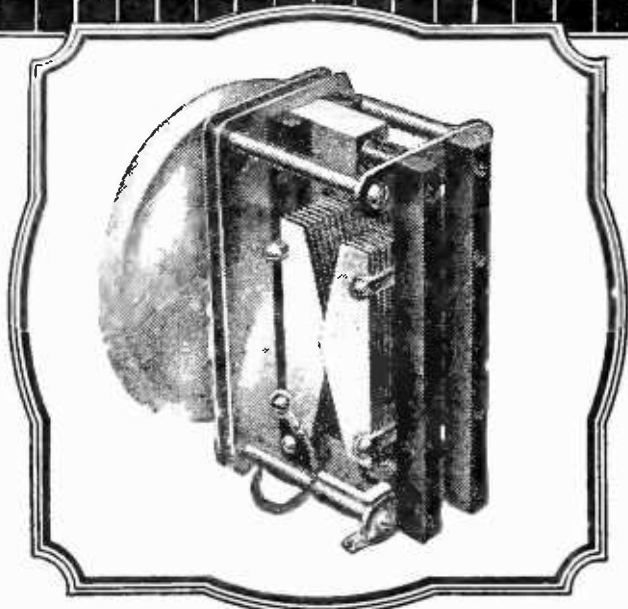
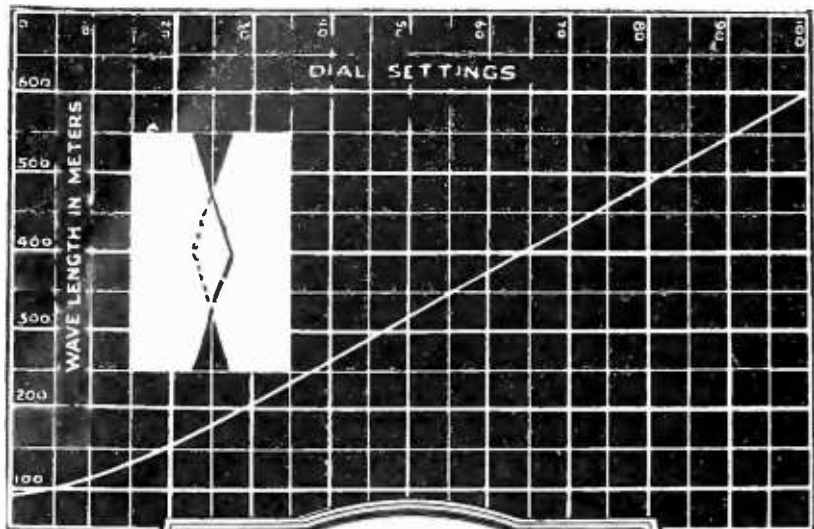

Pat.
App.
For

WADE Grounded Frame Condenser Unit

No Body Capacity

Grounded frame insulated from both sets of plates shields the condenser from all body capacity effects—a vital feature, exclusively in WADE Condensers.

Square Law—Angular cutting of plates gives perfect straight line wave-length curve — distributes the stations evenly over the dial.

Low Loss—Laboratory tests show phase difference angle and dielectric absorption losses too low to be accurately measured.

Low Minimum Capacity—Pointed plates and open back construction give lower minimum capacity and wider tuning range than that of any other condenser on the market.

Micrometer Dial—Silvered, 4-inch, 16:1 ratio, 360 degree vernier dial, furnished with each WADE condenser, insures the finest possible tuning control.

All sizes, complete with 4-inch vernier dial, for:

Short Wave, .000125 mfd. \$7.50

Tuned Radio Frequency .00025 mfd. \$7.75

Super-Heterodynes, .0005 mfd. \$8.00

Oscillators, Wave-meters, etc., .001 mfd. \$8.50

At your dealers, otherwise send us his name and purchase price and you will be supplied postpaid.

WADE MANUFACTURING CO., Inc.
1819-B Broadway New York, N. Y.



5 TUBE RADIO SET \$38.50 COMPLETELY ASSEMBLED



10 DAYS FREE TRIAL ★ **Coast to Coast**

Direct from factory to you at less than Dealer's Cost. Marvelous 5-tube radio set. Latest and most efficient TUNED RADIO FREQUENCY circuit Approved by America's Leading Radio Engineers. Easy to operate. Dials can be logged. Tune in your favorite stations instantly, on the same dial numbers every time. No guessing. Mr. Howard of Chicago said, "While 5 Chicago Broadcasting Stations were on the air, I tuned in 17 out-of-town stations from 40 to 1,000 miles away, on my loud speaker, very loud and clear as though they were all in Chicago."

Description: 5-tube set. Comes completely assembled in beautiful mahogany cabinet, size 25 x 7 1/2 x 7 1/2. Has 2 stages Tuned Radio Frequency, Detector and 2 stages Audio Frequency. Equipped with the highest quality, approved standard low-loss parts. Genuine Bakelite Panel, Bakelite dials. Use any standard tubes and batteries.

10 DAYS FREE TRIAL

Don't miss this chance to buy this high grade 5-tube set direct from factory. Regular value \$100.00. Our factory price only \$38.50. Send no money. Sign and mail coupon. Pay only \$38.50 when delivered (plus small transportation charges). Try it 10 days. If you are not delighted with results—if you do not consider it equal or better than any \$100.00 set, send it back and we will cheerfully refund your money.

Metro Electric Co.
400 N. Michigan Ave., Dept. 12, Chicago, Ill.
Gentlemen: Ship me on approval your 5-tube long distance radio set. I will pay \$38.50 on arrival (plus transportation charges) with the understanding that if I am not fully satisfied after ten days' free trial, I may return it and you will refund my money.

Name
Address
City..... State.....

KESTER Radio SOLDER
(Rosin-Core)
If your dealer cannot supply you
send us 25c in postage
CHICAGO SOLDER COMPANY
CHICAGO, U. S. A.



By W. B. MAXWELL:
The Day's Journey
"The novel is a masterpiece of comradeship on the highest level." Boston Herald. (\$2.00)
Doubleday, Page & Co.

★ Tested and approved by RADIO BROADCAST ★



Samson Super-Kit

Another Radio Achievement

KIT INCLUDES

- 3** Samson Long Wave Transformers
5000 meter wave length
- 1** Samson Filter Transformer
for this wave length
- 1** Samson Oscillator Coupler

*Also full information on how to
Build This Set*



All Samson Transformers are made with the
FAMOUS HELICAL WINDINGS

Remember that "Samson" stands for 42 years of leadership in the manufacturing of electrical specialties. Other Samson Products:

SAMSON
AUDIO TRANSFORMERS

SAMSON
PUSH-PULL TRANSFORMERS

Write for Proof of Samson Superiority

SAMSON ELECTRIC CO., Canton, Mass.
Manufacturers since 1882

Telos Radio

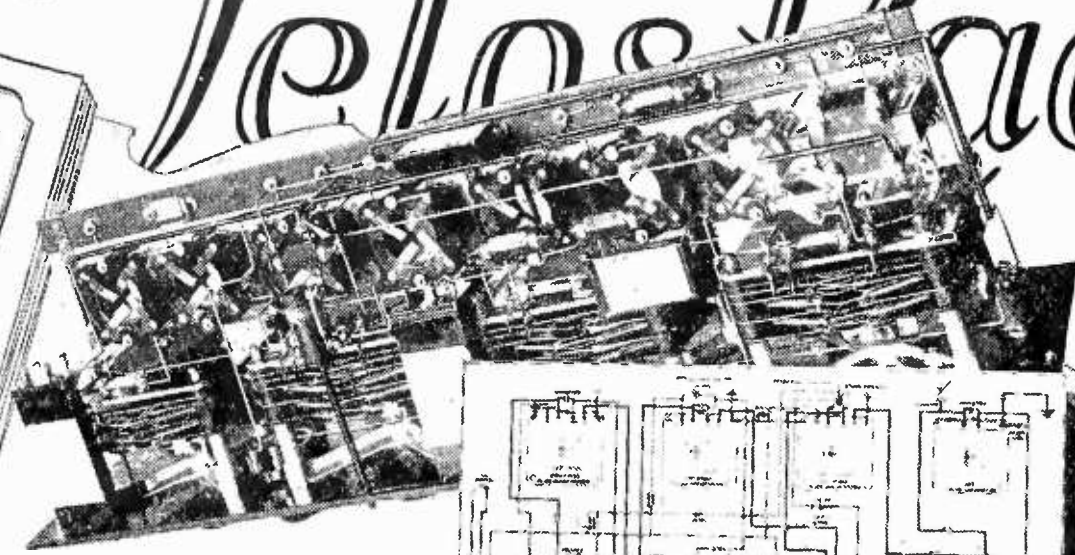
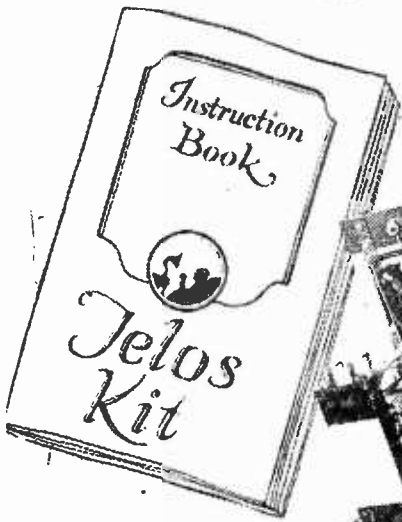

Interior wiring of a typical Telos Set. Every step is clearly explained in the instruction book and diagram.

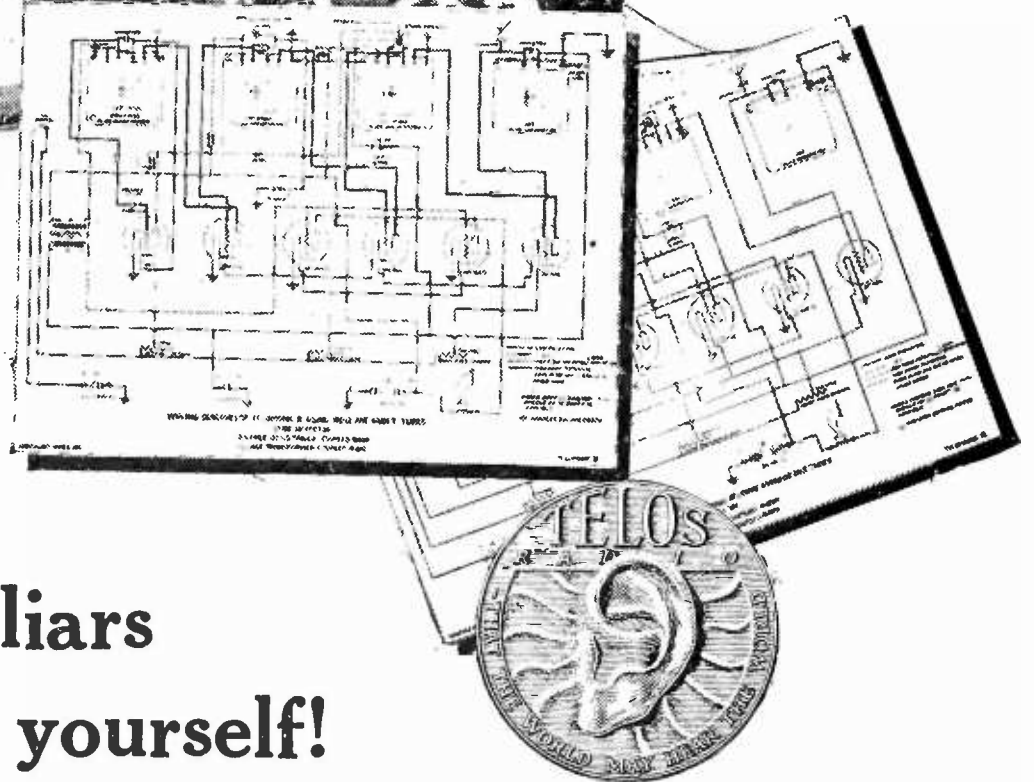

Don't call them liars write for the book yourself!

WHEN you run across a couple of Telos set owners—as everybody does nowadays—stop before you doubt the results they talk about. For you can easily find out whether such power, selectivity, at so little cost, is possible, by using the coupon below.

When you do find out how the Telos principle of tuned R.F. has been developed—how it makes three R.F. stages entirely practical—how the A.F. is superimposed (reflexed) on the R.F. tubes—how “Unicontrol works”—how 5, 6, and 7 dry cell tubes are made to operate with half the usual plate current—then, you will no longer doubt—but you will want a Telos set yourself.

And you will also find that you can easily build any one of the many interesting Telos sets in a single afternoon—the essential Telos instruments to build scores of circuits, based on the Telos principle, are *all* in the Telos Kit.



So fill out the coupon now! Don't doubt—know for yourself what Telos really does!

DANZIGER-JONES, Inc.
Dept. B
25 Waverly Place
New York, N. Y.

DANZIGER-JONES, Inc.
Dept. B, 25 Waverly Place
New York, N. Y.

Send me at once, your booklet
“The KIT of a Thousand Possibilities.”

Name.....

Address.....

.....

★ Tested and approved by RADIO BROADCAST ★

The **Four-Tube**

\$32.50

KODEL

Radio's Greatest Set Value

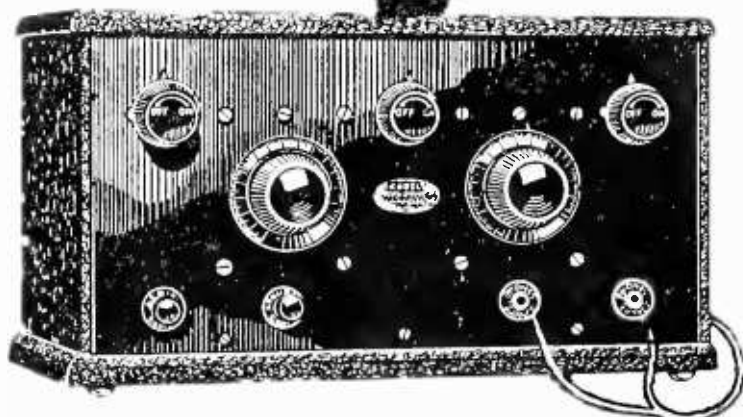

ANYONE can own a big set now. The four-tube KODEL with its marvelous range and volume, its amazing selectivity, its clear full tone, matches the performance of most expensive five-tube sets, and costs less than half as much.

KODEL is a quality receiver. Sockets and dials are of genuine Bakelite; panel of highly polished Formica; cabinet of handsome black pebbled leatherette — KODEL is Radio's Greatest Set Value!

Before you buy any set see the complete KODEL line at your radio dealers—“compare the quality.”

DEALERS

KODEL is the sensation of the season. Fans the country over are buying KODEL for its remarkable performance and its amazingly low price. Write for illustrated catalog of the complete line of KODEL quality receivers.



*Here Are All the
KODEL Models*

- S-1 Crystal Set.....\$ 5.00*
- C-11 One Tube Set..... 10.00*
- C-12 Two Tube Set..... 18.00*
- C-13 Three Tube Set..... 28.00*
- C-14 Four Tube Set..... 32.50*
- P-11 One Tube Portable..... 16.00*
- P-12 Two Tube Portable.... 22.50*

If your Radio Dealer cannot supply you, we will ship direct.

Write for complete catalog.

THE KODEL MANUFACTURING CO

128 W. Third St.,

Cincinnati, Ohio

★ Tested and approved by RADIO BROADCAST ★

D. T. W. THE SENSATION OF EVERY RADIO SHOW

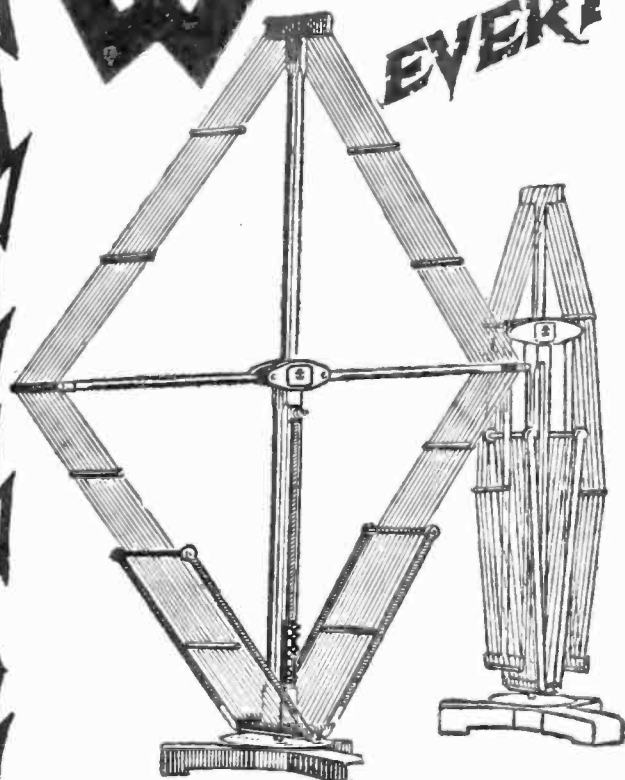

Range 100-800 meters

Height 42 inches. Width 40 inches

NOW \$25.00

Formerly \$35.00

THE BIG FEATURE AT THE RECENT SHOWS
NEW YORK, BALTIMORE, BOSTON AND CHICAGO

The 1925 D. T. W. Imported German Loop

Electrically and mechanically this loop has no equal. USE it—Compare it—if you do not find this to be true—Return it to your dealer, who is authorized to refund your money.

THIS amounts to a FREE trial.

Why the loop is a better loop:

1. Plan of construction.
2. Superior quality of materials used.
3. Original 60 strand German Litz.
4. Careful attention given to details of construction.
5. Method of cutting the inductance, allowing use as two or three tap loop. No dead end losses.

Distributor Zones now being allotted for loop and other D. T. W. Products. Progressive and responsible dealers solicited.

Manufactured by the Deutsche Telephonwerke und Kabelindustrie of Berlin, Germany. The telephone company of Germany.

If your dealer cannot supply you, order direct and we will ship Parcel Post C. O. D. **\$25.00** Formerly \$35.00 Shipped in a permanent cylindrical container. Money back guarantee.

\$1.50 extra west of Chicago

Usual Discount to Radio Dealers

TOBE C. DEUTSCHMANN, American Representative and Distributor
46 D, CORNHILL, BOSTON, MASS.



ARROW BATTERY SLASHES Prices TO CONSUMERS ONLY

Prices Smashed!

Quality Not Sacrificed

Here is real battery quality, guaranteed to you, at prices that will astound the entire battery-buying public. Order direct from factory. Put the Dealer's Profit in your own pocket. You actually save much more than half, and so that you can be convinced of true quality and performance, we give a **Written Two-Year Guarantee**

Here is your protection! No need to take a chance. Our battery is right—and the price is the lowest ever made. Convince yourself. Read the prices!

- Special 2-Volt Radio Storage Battery, \$3.75
- Special 4-Volt Radio Storage Battery, 6.00
- 6-Volt, 60 Amp. Radio Storage Battery, 7.00
- 6-Volt, 80 Amp. Radio Storage Battery, 8.00
- 6-Volt, 100 Amp. Radio Storage Battery, 9.50
- 6-Volt, 120 Amp. Radio Storage Battery, 11.50
- 6-Volt, 140 Amp. Radio Storage Battery, 13.00

We ask for no deposit. Simply send name and address and style wanted. Battery will be shipped the day we receive your order Express C. O. D., subject to your examination on arrival. Our guarantee accompanies each battery. We allow 5% discount for cash in full with order. You cannot lose! Act quick. Send your order today—NOW.

Arrow Battery Co.
1215 South Wabash Ave.
Dept. 10 Chicago, Ill.



"Good Parts Make a Good Set"



The Filter Tuner

THE BEL-TONE Low-Loss Filter Tuner takes all the guess-work out of building a Filter Tuner Set. This unit has been built to the exact specifications laid down by McGinnis and Maher of the N. Y. Journal. It bears their signature of approval.

The BEL-TONE Filter Tuner is made with bakelite tubes and green silk wire. It is packed in a neat box with complete instructions. **\$3.75**

BEL-TONE RADIO CO.

161-167 Jamaica Ave., Brooklyn, N. Y.

Other BEL-TONE Good Parts are: Bel-Tone Kit type AC-30, Bel-Tone Variometer, Bel-Tone Variocoupler, Bel-Tone Mounted Binding Posts.



★ Tested and approved by RADIO BROADCAST ★

Are You Fooled by "Low Loss" BUNK!

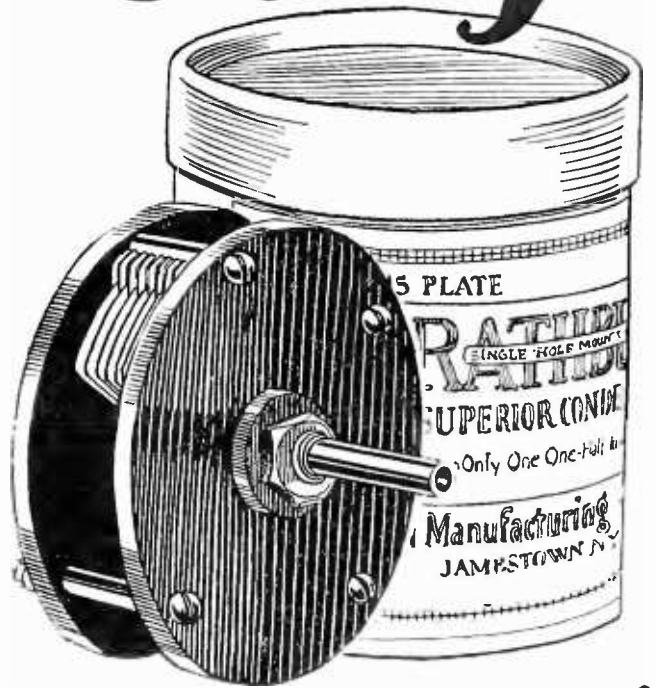

A RATHBUN Condenser is *Honest!*

Startling Statements that Say:

- "Our Condenser has No-Loss"
- "Our Condenser has Lowest-Loss"
- "Losses CANNOT BE MEASURED"

ARE BUNK

Engineers who know, will back us up on all statements that we make. Rathbun Superior Condensers are as near perfect as condensers can be made to-day. They are Low in Loss, highly efficient. (See LEFAX report).

When folks speak about low-losses in condensers, eddy-currents MUST be taken into consideration. Why? Because eddy-currents are often more serious than dielectric losses at radio frequencies. Eddy-currents do not exist in Bakelite End Plates. So why pay much more for condensers when you can buy Rathbun Superior Condensers that have genuine Bakelite End Plates?

H. F. Harmon, Engineer; formerly of Bureau of Standards, says: "Losses due to eddy-currents in metal end plates of condensers are more serious at radio frequencies than in condensers using a good dielectric material, such as Bakelite."

Sylvan Harris, Engineering Expert, says: "It is a safe bet to say that nearly all measurements which have heretofore been made of the resistance of condensers for radio receiving at radio frequencies have been incorrect, since many fallacious assumptions have been made. A new and exact method of making these measurements has recently been developed and a great many condensers have been measured by this method. In these measurements it was proven conclusively that in

the average condensers on the market, whether it be the low-loss type or the old style, that the dielectric losses represent on the average 10% or less of the total resistance of the condenser. It is therefore evident that there are other losses in condensers than dielectric losses, the reduction of which may result in considerable more improvement than is effected by merely replacing end plates of insulating material with metal end plates."

NOTE THESE POINTS: LOW PRICES—\$1.00 to \$4.50, single-hole-mounting, overall plate protection, correct alignment, rigid, simple, light, compact, and durable. Nothing to get out of adjustment. Will stand a lifetime of service. Low-loss and high efficiency.

Money-back GUARANTEE: If you can get longer distance, sharper tuning, clearer reception or more volume with any other condenser on the market to-day, return ours and get your money. The LEFAX report is included in our "CONDENSER GUIDE" which presents many truthful facts that you'll be glad to know to guide you in the purchase of condensers. Write for it.

Rathbun Claravox Superior Radio Reproducer

Have you heard the NEW Rathbun Claravox Superior Radio Reproducer? Not just a "Loud Speaker" but a real Radio Reproducer—a great surprise for your eyes and ears. Write for details.



RATHBUN MANUFACTURING COMPANY, INC.

Dept. RB3 Jamestown, N. Y.



RATHBUN SINGLE-HOLE MOUNTING SUPERIOR CONDENSERS

← Molded on every original single-hole-mounting, low-loss, unconditionally guaranteed Condenser.

★ Tested and approved by RADIO BROADCAST ★

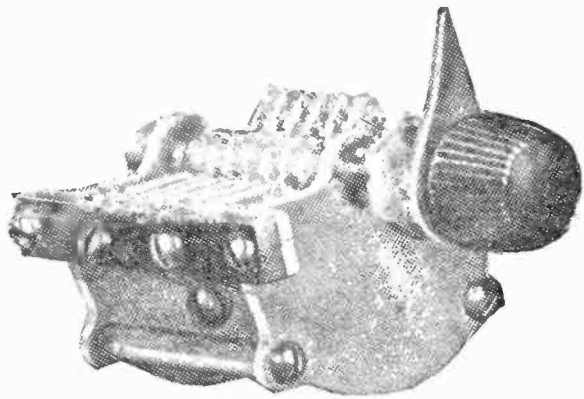
NEW!**CONTINENTAL**
LO LOSS

Take off all existing vernier attachments and let Junior make your set 100% efficient.

Price \$1.50

JUNIOR CONDENSER**At Last! The Perfect Vernier**

IT has arrived! The one instrument you have been waiting for to make your set perfect! **CONTINENTAL Lo Loss JUNIOR CONDENSER.**

This little condenser is an exact replica of its famous big brother with all of his fine qualities—lowest losses, rigid construction and precision workmanship. Drill one hole in panel, hook up **JUNIOR** to your present big condenser *and you have a perfect vernier!*

Junior permits gradations impossible to get with vernier devices and brings in with amazing ease "those stations you can't get."

Junior in Size — Junior in Price!

If your Dealer can't supply you—write us Direct

GARDINER & HEPBURN, Inc.

Sales Dept. 611 Widener Bldg. PHILADELPHIA Factory, 2100 Washington Ave.

**NO REFLEX COMPLETE
WITHOUT CELERUNDUM COMPLETE**



DE-TEX-IT

Complete \$1.25

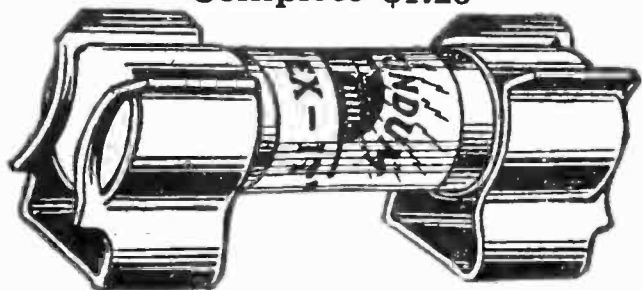

**A low loss positive contact
Fixed Detector**

Requires no adjustment. Cat whisker troubles eliminated. Will not burn out.

**Best for Reflex
Power-Tone-Volume**

Jobbers write for samples and discount

Celerundum Radio Products Co.

70-78 Woodbine Street,

Wollaston, Mass.

"NOL-LOS"
Variable Condenser \$4.00
Capacity .0005 ME

- 1—Sharp Tuning
- 2—Perfect Shielding
- 3—No Body Capacity
- 4—Mechanically Rugged
- 5—Easy to Install
- 6—Built to All Capacities
- 7—Losses so Low that they are negligible.

**The Perfect Condenser
for Any Circuit**

"Nol-Los" the Perfect Condenser appeals strongly to every Radio Fan and Scientific Experimenter. Built of aluminum, it is mechanically rugged and easily mounted in any position, requiring only one hole in panel.

Its superiority over any other Condenser produced is universally acknowledged.

It has withstood the severest laboratory tests.

When buying a Condenser, ask for "Nol-Los."

Dealers and Jobbers write for terms.

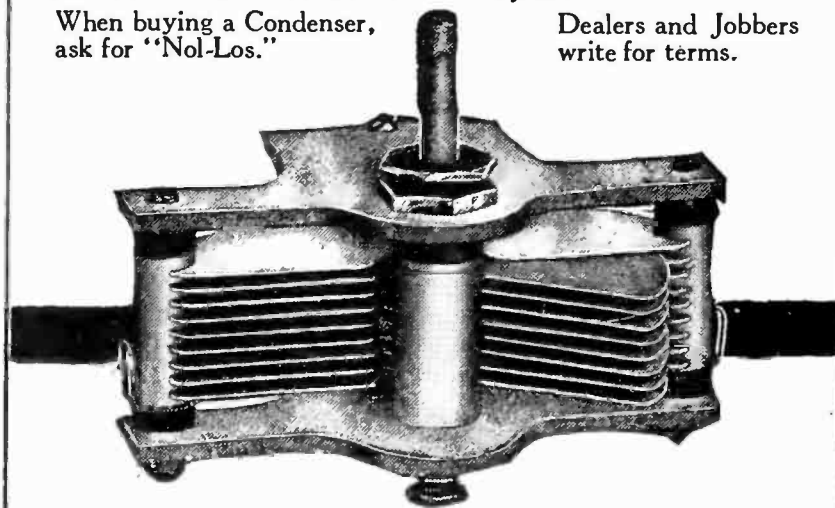

B. GROSSER SONS CO., INC.
53 Sudbury Street Boston, Mass.

★ Tested and approved by RADIO BROADCAST ★

SWEETEN THE AIR With Air-Way

No matter how modest the ideas of the radio beginner, he soon begins to search for distant stations.

Then is when he appreciates an AIR-WAY Receiver.

All distant signals come to any set, but they will not fight their way in through unnecessary losses and high resistances.

AIR-WAY Receivers are the last word in LOW LOSS construction and tuned radio frequency amplification and build up the weakest signals to pleasing audibility.

Oscillation is perfectly controlled and all extraneous noises eliminated without neutralizers or complicated adjustments.

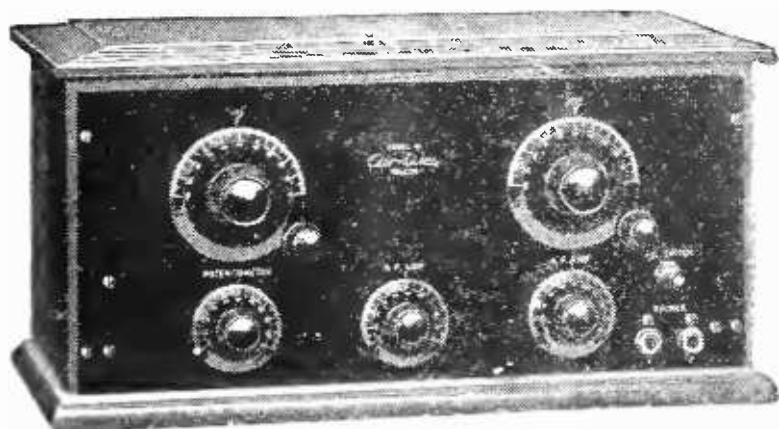

AIR-WAY No. 41, 4-Tube

We claim without reservation that AIR-WAY Model 41 is superior in every quality of radio reception to any other four-tube set ever built, and unequaled by any set at less than nearly twice the price.

The selective qualities are unexcelled in any set, operating on an outside aerial.

The dignified design of the solid walnut case and the workmanship and finish of the panel equipment give it an outward appearance

in keeping with the operative quality.

A set that meets all market conditions and all individual requirements; one that the Dealer may sell to the inexperienced user or the most discriminating expert and be sure that either will attain results satisfactory in every way. Price \$65.00.

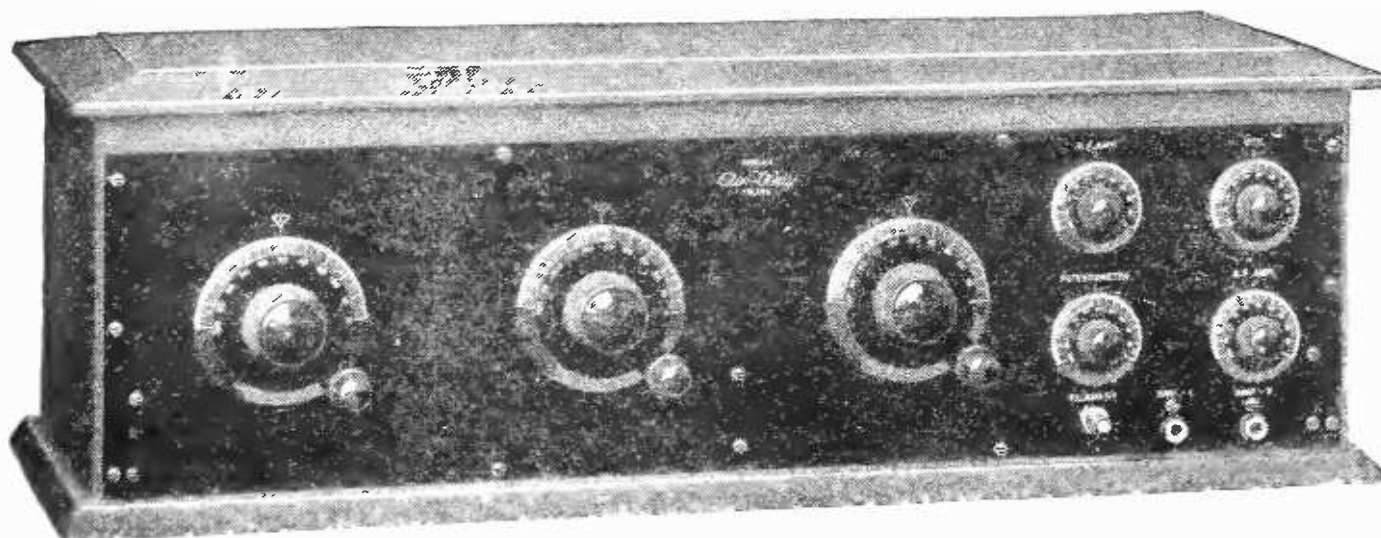

AIR-WAY No. 51

The latest development in tuned radio frequency with two stages of radio frequency amplification, detector and two stages transformer coupled audio frequency amplification.

Offered without reservation as a set that will give general satisfaction to all broadcast listeners regardless of previous radio experience.

Price, as illustrated, \$125.00.

Also furnished in handsome Console type cabinet of solid walnut. Price, \$375.00.

AIR-WAY Apparatus is the result of several years' study and development by skilled radio engineers, and is strictly up to the minute in radio design.

Operation is simplified to the limits of the radio novice, and quality throughout is developed to meet the demands of the most discriminating of radio experts.

AIR-WAY Apparatus is distributed through established Jobbers and Dealers only. Write our Sales Department for Catalogue of the complete line.

★ AIR-WAY ELECTRIC APPLIANCE CORP.
TOLEDO, OHIO

★ Tested and approved by RADIO BROADCAST ★

RESAS Tone-A-Dyne

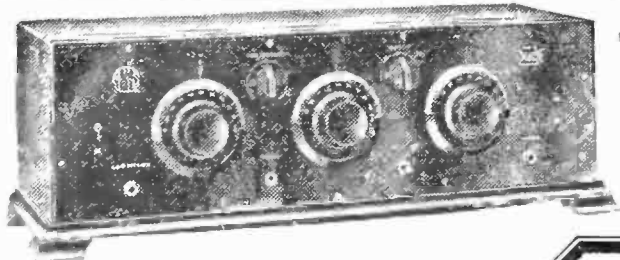

It Costs
\$72.00 Less

\$78

Far too many people are misled by taking the price of a radio set as an indication of its intrinsic value. Because one set is higher priced than another, it does not follow that that set has greater value.

Place the Resas Tone-A-Dyne set side by side with any other set selling for twice the price and compare their performance. You'll find that the Resas Tone-A-Dyne will do anything the higher priced set does.

This 5-tube set will give unexcelled volume and clarity on indoor and outdoor antenna. And the exclusive Tone Modulator permits regulating the tone and volume simply by turning a knob. It tunes right through locals. Distant stations are always at your command.

In everything except price, the Resas Tone-A-Dyne is a \$150.00 set. It is fully guaranteed.



Write for booklet.

RESAS, Inc.
112 Chambers St. New York

PYREX INSULATORS



A STITCH IN TIME SAVES NINE

AN hour to change your antenna insulators and install PYREX will save many hours of poor reception.

At all Good Dealers

★ **PRICE 45c EACH**

CORNING GLASS WORKS

Industrial Division

CORNING

NEW YORK

CARTER PORTABLE Jack



75c

For extending Loud Speaker or head set. Takes any standard Plug. SCREW Terminals.

Any dealer can supply.

In Canada—Carter Radio Co., Limited—Toronto, Canada ★

Carter Radio Co.
1806 REPUBLIC BUILDING
CHICAGO

Let the non-directional Thor Speaker Lamp

[Patents Pending]

bring in your Radio programs and furnish light at the same time. Many models—many styles—parchment or any color silk shades.

Table lamp models \$35.

At your dealers—or delivered.

★ **THOR Radio Division**
of the Golden Gate Brass Manufacturing Co.
1239-1243 Sutter St., San Francisco, Cal. (125)



Send For This Sensational Radio Bargain Book-FREE

Order Direct from This Page! Save About One-Half!

Compare our prices with others. Only highest grade nationally known GUARANTEED parts. OUR GUARANTEE PROTECTS YOU. Money cheerfully refunded if you are not satisfied. Be sure to write your order and state prices plainly. Send post office or express money order or bank draft for total amount to insure prompt shipment. ALL PRICES ON THIS PAGE INCLUDE SHIPPING CHARGES RIGHT TO YOUR DOOR. Refer to any bank or commercial agency regarding our reliability. If your favorite circuit is shown here, order direct from this ad. No skill required to build your own radio with Randolph parts. Panels are all drilled. Instructions are simple and complete. Everything comes ready to assemble. Order direct! All shipping charges prepaid.

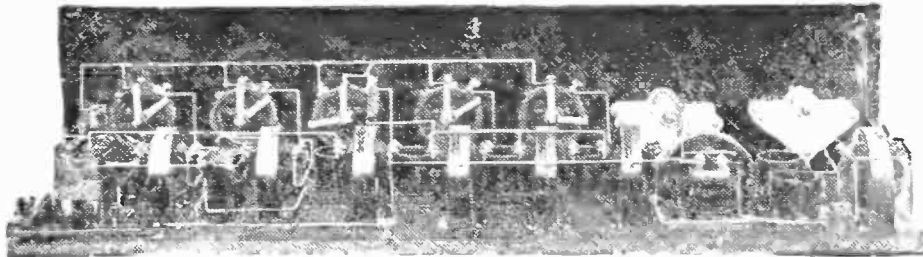

COMPLETE PARTS FOR 8-TUBE

SUPER-HETERODYNE

- 2 23-Plate Bremer-Tully or Duplex Low Loss Condensers
- 3 Remler or Columbia Intermediate Frequency Transformers
- 1 Remler or Columbia Tuned Circuit Transformer
- 1 Special Oscillator Coupler
- 1 Midget Condenser
- 8 Bakelite Sockets
- 2 Thordarson or Columbia A. F. Transformers
- 1 Connecticut Filament Switch
- 2 Bakelite 6 ohm Rheostats
- 2 Bakelite 30-ohm
- 1 Bakelite Potentiometer, 400 ohms
- 1 Carter Double Circuit Jack
- 1 Dubilier 1 mfd. Condenser
- 1 .006 Mica Condenser

- 1 .0005 Mica Condenser and 2 megohm Grid Leak
 - 3 .0025 Mica Condensers
 - 10 Binding Posts
 - 1 .00025 Mica Condenser
 - 1 Bakelite Terminal Strip for Binding Posts
 - 1 Multicord cable for connecting batteries
 - 1 7x30x3/8 Drilled Bakelite Panel
 - 1 Baseboard
 - 35 ft. Hook-up Wire
 - 2 4 in. Bakelite Dials
 - 2 4 1/2 volt C Batteries
- \$59⁷⁵
- Complete wiring diagrams, base board layout, blue-prints and instructions.

COMPLETE PARTS FOR
2-Tube Harkness Set
including Licensed Harkness Coils, Drilled Panel and wiring diagram. Easy to build. Wonderful results. **\$17.95**

COMPLETE PARTS FOR
Two Stage Amplifier
with Thordarson or Columbia Transformers; with drilled panel & wiring diagram **\$10.90**

Randolph Special Headphones
2200 Ohm..... **\$2.45**
3000 Ohm..... **2.95**

COMPLETE PARTS FOR
ACME 1-Tube REFLEX.... **\$17.45**
ACME 4-Tube REFLEX.... **39.85**

with Genuine Acme parts as specified, drilled bakelite panel and full wiring diagram.

COMPLETE PARTS FOR
Reinartz
1-Tube Reinartz Set.... **\$10.45**
3-Tube Reinartz Set.... **17.55**

Our Guarantee
Every article exactly as represented. Every article is tested before shipping. Complete satisfaction guaranteed or money will be cheerfully refunded.

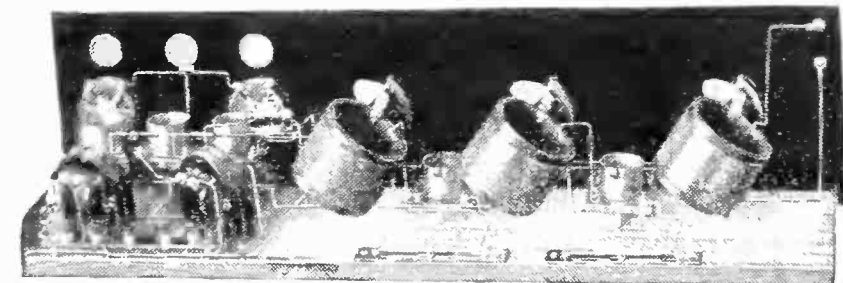

COMPLETE PARTS FOR 3 AND 5-TUBE **NEUTRODYNE RECEIVING SET**
Genuine Hazeltine Licensed Neutrodyne Parts Furnished.

- PARTS FOR 5-TUBE SET
- 1 7x24x3/8 Drilled Panel
 - 2 Thordarson or Columbia Audio Transformers
 - 3 4" Bakelite Dials
 - 2 Precision Jacks
 - 1 Bakelite Rheostat, 30 ohm
 - 1 Bakelite Rheostat, 6 ohm
 - 1 Bakelite Binding Post Strip
 - Complete blue-prints and working diagrams.
 - 7 Marked Binding Posts
 - 1 Grid Leak and Condenser
 - 5 Bakelite Sockets
 - 1 .001 Condenser
 - 1 .006 Mica Condenser
 - 35 feet Hook-up Wire
 - 1 Kit consisting of 3 Hazeltine Licensed Neutroformers and 2 Neutrodons **\$33⁷⁵**
 - 1 Baseboard
 - 2 Bezels

Easy to build your own radio set. All complete parts for sets consist of standard advertised guaranteed parts and include drilled bakelite panels and wiring diagrams for easy set construction. Everything guaranteed on money-back basis. All transportation charges paid.

FREE — BIG MONEY SAVING RADIO CATALOG containing a thousand bargains of everything on radio—parts, supplies, complete parts for sets, complete sets, etc., also a mine of very latest information on all different circuits, complete list of broadcasting stations, and other valuable, up-to-the-minute radio data. Send your name and address on a card or letter. We will send catalog free.

FREE Service Department
Our radio engineers will help you solve all your radio problems, and furnish up-to-date information on set construction, operation and improvement. This service is free to our customers.

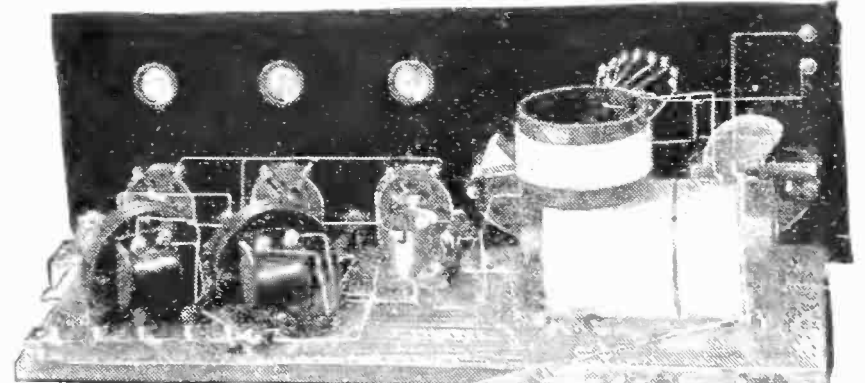

COMPLETE PARTS FOR 3-TUBE **COCKADAY RECEIVING SET**

- 1 Cockaday Coil
 - 2 23-Plate Hy-Grade Cond.
 - 1 Bakelite Rheostat, 6 ohm.
 - 2 Bakelite Rheostat, 30 ohm.
 - 3 Bakelite Sockets
 - 1 high ratio Columbia or Thordarson Transformer
 - 1 Single Circuit Jack
 - 1 low ratio Columbia or Thordarson Transformer
 - 2 Double Circuit Jacks
 - 2 3 in. Bakelite Dials
 - 1 Grid Leak and Mica Cond.
 - 7 Switch Points. 2 stops.
 - 1 Bakelite Binding Post Strip
 - 7 Binding Posts
 - 1 7x21x3/8 in. Drilled Bakelite Panel
 - 3 Bezels
 - 1 Baseboard
 - 1 switch lever
 - 24 ft. Hook-up Wire
- \$19⁹⁵
- Complete blue-prints and wiring diagrams.
1-Tube Set..... **\$10.45**

Complete Parts for **5-Tube Improved Cockaday Receiving Set**
With Resistance Coupled Amplification
As designed by L. M. Cockaday. Including drilled panel and wiring diagram complete, ready to wire. **\$39⁶⁵**

RANDOLPH RADIO CORPORATION
159 N. Union Ave. Dept. 346 Chicago, Illinois

BAKELITE

TRADE MARK REG. U. S. PAT. OFF.



Endorsed by Remler, Too—

Manufacturers know from experience that radio parts must be constructed with the best materials, if satisfactory service is to be obtained. That is why the Remler Radio Mfg. Co. of San Francisco uses Bakelite for tube sockets, variometers and many other parts.

As an insulation, Bakelite is in a class by itself. It possesses high dielectric strength, is unaffected by atmospheric changes, and its properties are not impaired with age.

Insist on genuine Bakelite radio parts, and you can rest assured that your equipment is of the highest quality.

Send for our Booklet R

BAKELITE CORPORATION

247 Park Avenue, New York, N. Y.
Chicago Office: 636 West 22d Street



THE MATERIAL OF A THOUSAND USES

The LARGEST RADIO STORES in AMERICA

Hook-ups!

All the latest and best "Kits" in our new

RADIO CATALOG



FREE

NO other Radio Catalog includes such a complete assortment of the best and latest Knock-Down Kits, Parts and Accessories. You need this book — Write for your FREE copy today!

We Save You Money!

Our business is to buy up manufacturers' and government surplus stocks, jobber and dealer bankrupt stocks — but only brand-new, fully guaranteed, nationally advertised apparatus. Our enormous buying power permits us to pay spot cash and get rock-bottom prices — even way below manufacturer's costs. That's why our catalog is crammed with thousands of wonderful Radio Bargains.



509 So. State St., CHICAGO, ILL., Dept. R.B.6



12 Cells
24 Volts
Solid
Rubber
Case

\$4.00
C.O.D.

SPECIAL INTRODUCTORY PRICE

For a limited time *only*, and to introduce this new and superior Storage "B" Radio Battery to the Public, we are selling it for \$4.00. Regular Retail Price is \$6.00. You save \$2.00 by ordering NOW. A finer battery cannot be built than the

World Storage "B" Battery (12 CELLS—24 VOLTS)

To ten million homes with Radio Sets—and to countless millions of prospective buyers—this WORLD Storage "B" Battery brings a new conception of battery economy and performance. Here is a battery that pays for itself in a few weeks—will last for years and can be recharged at a negligible cost. *And you save \$2.00 by ordering now.*

A Superior Battery Equipped With Solid Rubber Case

Has heavy duty 2-1/8 in. x 1 in. x 1-4 in. plates and plenty of acid circulation. Extra heavy glass jars allow ready observation of charge and prevent leakage and seepage of current. It holds its charge, while idle, at constant voltage. You will find this battery a boon to long distance reception. It does away with a great many noises so often blamed on "static." Mail your order today.

SEND NO MONEY

Just state number of batteries wanted and we will ship day order is received. EXTRA OFFER: 4 batteries in series (96 volts), \$15.00. Pay Expressman after examining batteries. 5 per cent discount for cash in full with order. Send your order NOW and save \$2.00.

WORLD BATTERY COMPANY

Makers of the famous World Radio "A" Storage Battery
1219 S. Wabash Ave., Dept. 78, Chicago, Ill.

SAVE \$2.00 BY ORDERING NOW!

★ Tested and approved by RADIO BROADCAST ★

Here's a rain You won't want to "Come out of!"

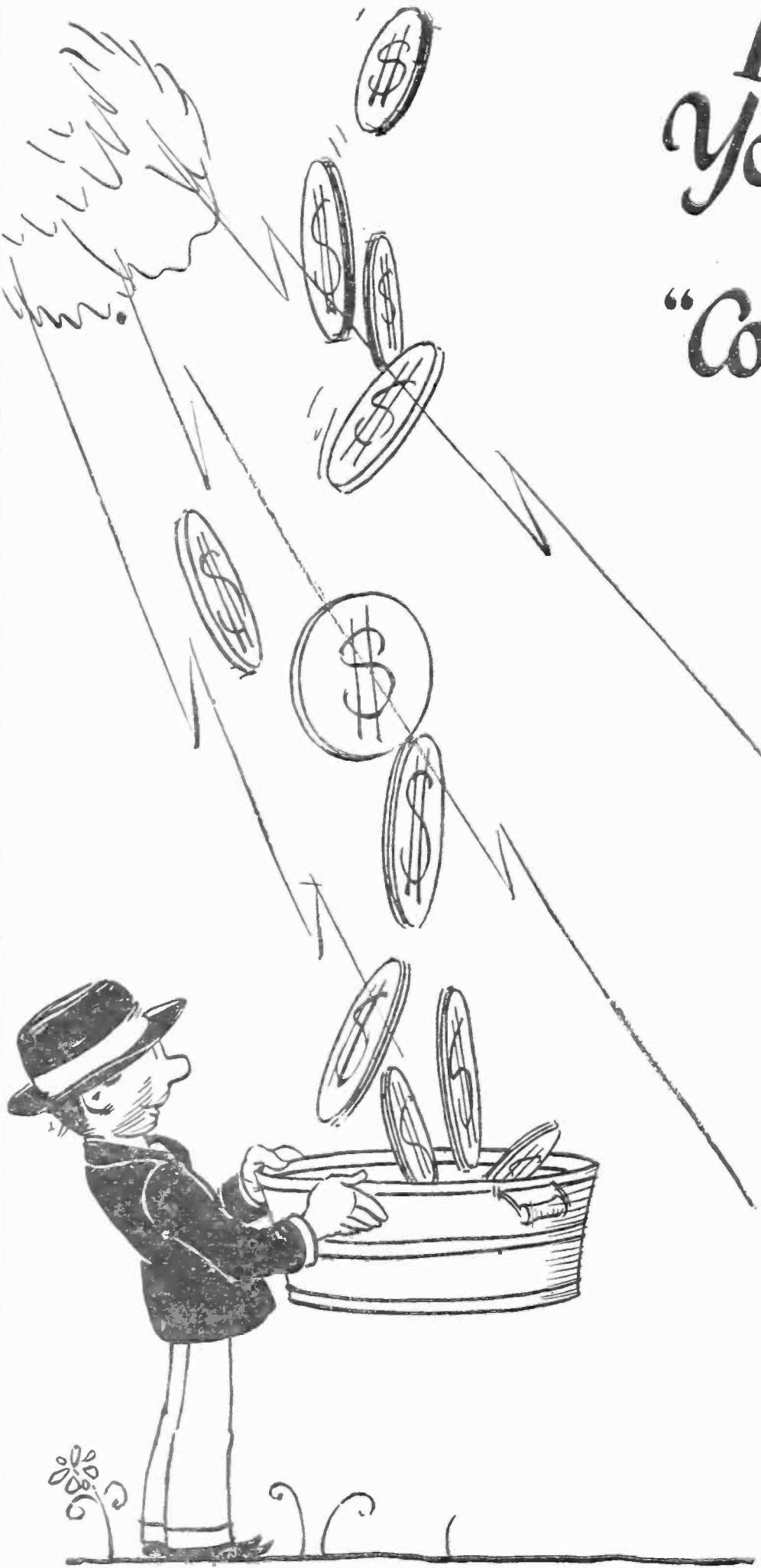

In fact, you'd be downright willing to get drenched by such a shower.

You can bring it on yourself very easily—Here's the secret.

Stock the lines shown below and tie up with Hommel, the helpful jobber. He will sell you only material that is in demand. Hommel wholesales only, he will not compete with you because he does not retail to your customers. This also means that he will give you material even when it is scarce, because he will not sell it over a retail counter. He is noted for prompt shipments and will give you liberal discounts and play fair with you at all times.

Get these benefits—Tie up with Hommel. His Encyclopedia of Radio Apparatus 266-B is free for the asking and will help you.

DISTRIBUTORS FOR
Radio Corporation of America

 Westinghouse General Electric

Baldwin Brandes Burgess
Cardwell Crosley
Cutler-Hammer
Dubilier Fada Freed-Eisemann
Freshman Frost
General Radio Grebe
Haynes-Griffin Magnavox
Remler Rhamstine
U.S. Tool Western Electric
And other
leading manufacturers

WHOLESALE

EXCLUSIVELY

LUDWIG HOMMEL & CO

929 PENN AVENUE



PITTSBURGH, PA.

And Now

The ECHOPHONE

"4"

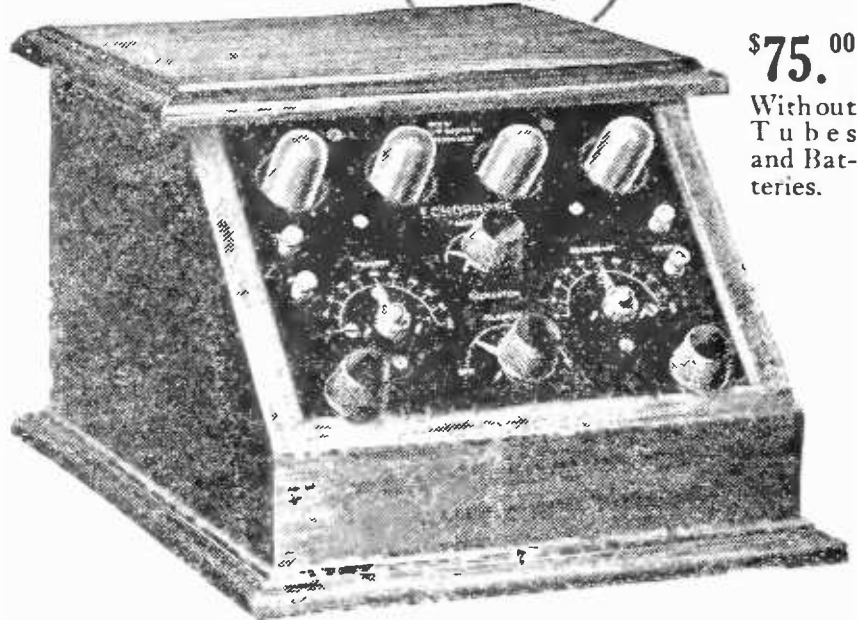

\$75.00
Without
Tubes
and Bat-
teries.

For Cutting Through Powerful Locals



The Echophone "V-3" an exceptionally powerful 3-tube set. Uses dry batteries. Two dial tuning. Range 1800 to 2000 miles. Without Tubes and Batteries
\$50.00.

ONE setting of the two tuning controls of the new ECHOPHONE "4" selects *only* the station desired—rejecting all others regardless of their power or the nearness of their wave lengths. Once the dial-setting for a given station is determined, that station always comes in if it is on the air when the dials are again placed in the same positions.

All parts are assembled in a handsome Adam Brown mahogany finished cabinet which has ample space for batteries.

Never before has a four-tube receiving set offered so much in *volume*, tone quality and selectivity! Ask your dealer for a demonstration. Meantime send for descriptive folder. Address

ARMAC RADIO CO.

1120 N. Ashland Avenue
Chicago, Ill.

Manufactured by The Radio Shop, 1120
N. Ashland Ave., Chicago, Ill.
Long Beach, Cal. Sunnyvale, Cal.



ECHOPHONE

Storage Battery Results at Dry Cell Cost

"MODERN RADIO RECEPTION"

A New Book

By

Charles R. Leutz

325 PAGES
200 ILLUSTRATIONS
FULLY BOUND

Partial List of Contents:

Radiola Super-Heterodyne Diagram

Western Electric 4B Receiver

Model C Super-Heterodyne

Model C7 Super-Heterodyne

Long Distance Reception

Short Wave Reception

Long Wave Receivers

Pliodynes and Super-Pliodynes

Laboratory Equipment

Broadcast Transmitters

High Efficiency Amateur Transmitters

Model L Super-Heterodyne

and

Everything of importance relating to Broadcast Reception

This supersedes Mr. Leutz's earlier book entitled "Super-Heterodyne Receivers"

Price **\$3.00** Postpaid

EXPERIMENTERS INFORMATION
SERVICE, Inc.

476 Broadway

New York City

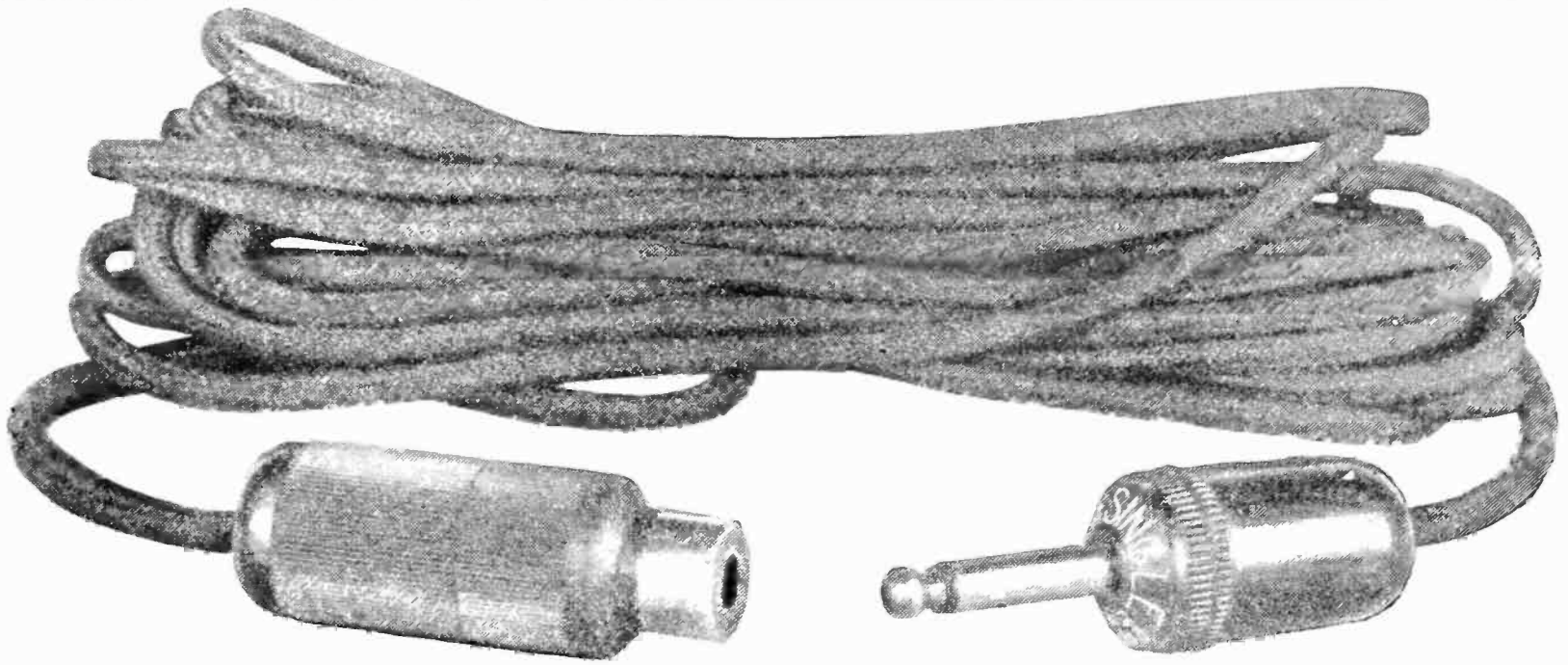

enjoy your loud speaker *thruout* the house!

Get 100% more use and pleasure out of your radio by means of

• • THE FOUR WAY • •

Loud Speaker Extension Unit

• • • • COMPLETE • • • •

THIS COMPLETE UNIT enables those who wish to use the loud speaker in other parts of the house to do so without removing set. Simply insert plug from loud speaker into jack and put plug on end of cord into set. This can be done readily and saves the trouble of using tools or soldering iron.

Prices, including jack, plug and cord

10 ft. cord . . .	\$2.25	40 ft. cord . . .	\$3.00
20 ft. cord . . .	2.50	50 ft. cord . . .	3.50
30 ft. cord . . .	2.75	100 ft. cord . . .	5.75

The JACK comes separately at \$1.00
at THE BEST DEALERS' everywhere

Manufactured by

FOUR WAY CO., Division B
Myrick Bldg. Springfield, Mass.

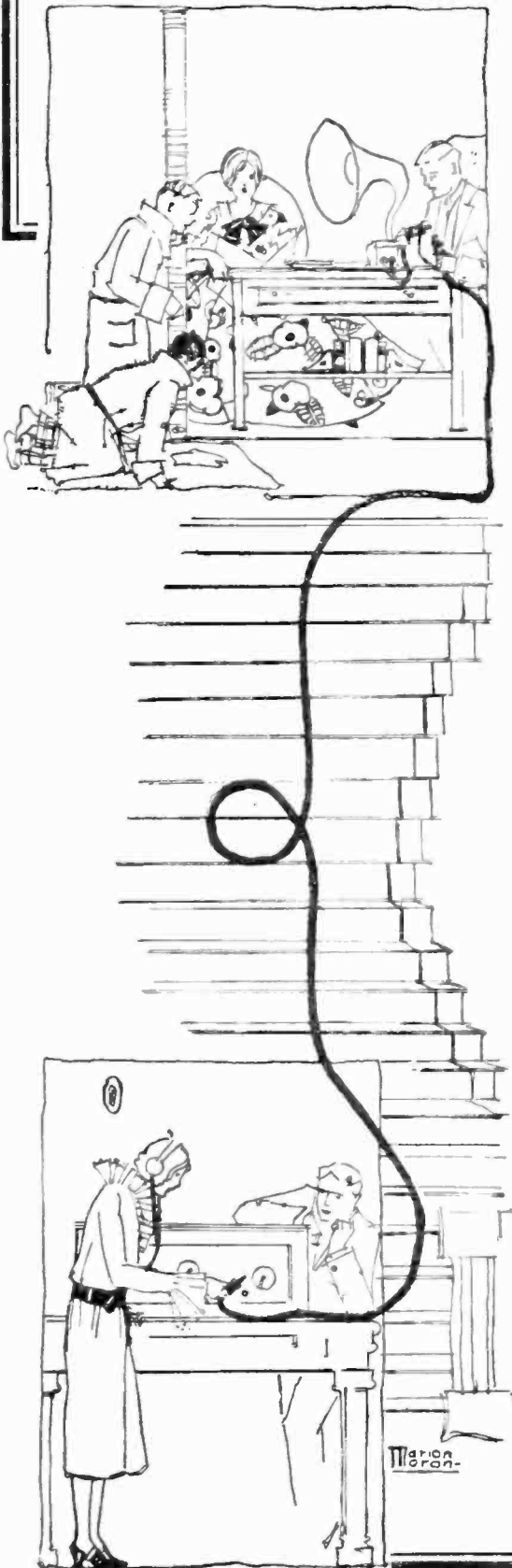

★ Tested and approved by RADIO BROADCAST ★

The Greatest Book on RADIO ever written

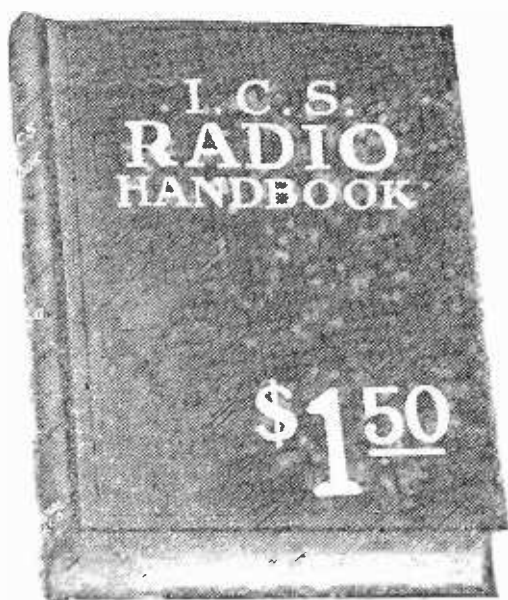

514 PAGES

Compiled by HARRY F. DART, E.E. Formerly with the Western Electric Co., and U. S. Army Instructor of Radio Technically edited by F. H. DOANE
MORE THAN 100,000 SOLD

New Leatheroid Edition just off the press! The greatest book on radio ever written. Price only \$1.50. Filled with sound, practical, *tested* information for every radio fan, from beginner to hard-boiled owl. Written, compiled and edited by radio experts of national reputation.

Every page tells you something useful. And there are 514 pages! More than 150 illustrations and diagrams!

You may dip into this I. C. S. Radio Handbook at random, or hunt up special information you want, or read it right through. Different types of receiving and sending hook-ups are explained; interesting experiments; definitions; codes and symbols; technical data and thousands of suggestions for getting more pleasure out of radio. Will save you from wasting money on things that won't work. 100,000 already sold.

Send \$1.50 today and get this 514-page I. C. S. Radio Handbook before you spend another cent on parts. Money back if not satisfied.

INTERNATIONAL CORRESPONDENCE SCHOOLS
Box 8295-D, Scranton, Penna.

I am enclosing \$1.50. Please send me—post-paid—the 514-page I. C. S. Radio Handbook. It is understood that if I am not entirely satisfied I may return this book within five days and you will refund my money.

Name.....

Address.....

Check here and enclose \$1 if you wish the cloth-bound edition.

the Panel SUPERFINE

No other material known possesses the many combined advantages for radio paneling as does Dilecto. It has every endorsement of dealer and manufacturer, because it is practically indestructible.

The Continental Fibre Co.
Factory: Newark, Delaware

NEW YORK, Woolworth Bldg.
CHICAGO, Wrigley Building
PITTSBURGH, Farmers Bank Building
SAN FRANCISCO, 75 Fremont St.
LOS ANGELES, 307 S. Hill St.
SEATTLE, 1041 Sixth Ave., So.

★ Look for the Red Stripe

Offices and agents throughout the world

Dilecto

The "Works" of the DeJur one hole RHEOSTAT

Genuine Bakelite Throughout

Note below how the contact slider and shaft are made in one piece. Permanently set at the factory, this insures perfect contact throughout the entire resistance range. The one hole makes DeJur the easiest rheostat to mount and when mounted it sets fixed and rigid. No screws to get loose and no back panel fusing. Compare the DeJur. You will readily recognize its difference and superiority.

At dealers everywhere
Jobbers—Write for discounts

Patents applied for

DE JUR PRODUCTS Co.,
Lafayette & Broome Sts.
New York

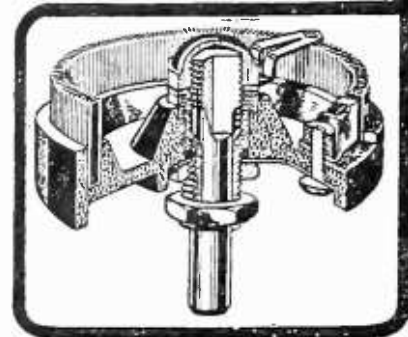

★ Tested and approved by RADIO BROADCAST ★



Make dumb Loud Speakers talk!

Don't blame the circuit or yourself if only noise comes from your loud speaker. Hilco apparatus makes the dumbest loud speaker talk.

The Hilco Laboratories contain special equipment of marvelous accuracy for determining whether new circuits and apparatus developed by Hilco research engineers will give maximum satisfaction.

Ever striving for perfection, Hilco developed a new type of Fixed Condenser guaranteed accurate within 5% of rating; the famous 7-tube Super Hilco-Dyne Kit enabling anyone to construct at a moderate cost, radio's most superb receiver; the Hilco Lo-Loss Tuned Radio Frequency Kit and the Hilcoflex Kit, containing essential parts for building really efficient 5 and 3 tube sets at

little cost; the Hilco Multiformer perfecting the Reflex and Neutrodyne when used as replacement coils.

When you buy Hilco apparatus for improving your present receiver or the construction of a new one you are getting the latest in scientific radio apparatus that is distinctively different and superior in efficiency and appearance.

Literature describing Hilco products free—Blue Prints of circuits sent at actual mailing cost of 10c.

Ask Your Dealer

about Hilco Products, especially

- Super Hilco-Dyne Kit . . . \$30.00
- Lo-Loss T.R.F. Hilco Kit . . . 17.50
- Hilcoflex Kit 8.50
- Hilco Multiformer 2.25
- Hilco Fixed Condensers.
- Hilco Super Het replacement parts for perfecting Super Hets.

WRITE FOR DESCRIPTIVE MATTER

★ Please Address Dept. 12

A. E. HILL MFG. CO.
Atlanta  *Georgia*

★ Tested and approved by RADIO BROADCAST ★

Dulce-Tone

Radio Talking Machine Speaker

Dulce-Tone Gives Clearer DX Reception



Model "V" Dulce-Tone is for Victrolas only.

Model "S" fits all other talking machines.

The two models are not interchangeable.

Dulce-Tone utilizes the COMPLETE, "balanced" reproducing unit of the talking machine. Signals are clear, precise, undistorted. Actual tests prove conclusively that distant reception reproduced through a good talking machine by the Dulce-Tone, is more distinct than through any type of ordinary loud speaker.

The market for Dulce-Tone is almost unlimited. Dulce-Tone is a quick and easy seller that will greatly increase your volume of sales. The moderate price means rapid, profitable turnovers.

Retail Price
\$10

Write for details.

THE TEAGLE COMPANY, 1125 Oregon Avenue, Cleveland, Ohio



BRANSTON RADIO

Make 7 Tubes do the Work of 10 in Super Heterodyne Set You Can Build

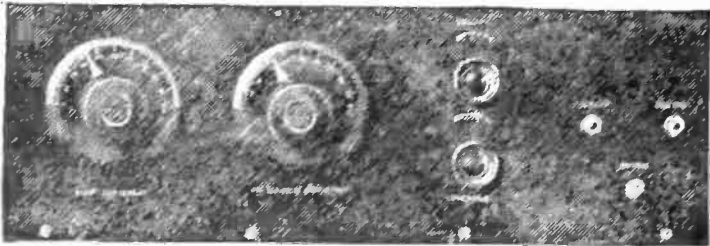

Panel Size 7x21 Inches—Only 2 Controls

THIS set was built using the Branston Kit shown below. It is a strictly loop set of coast-to-coast range. It has remarkably fine tonal qualities, great volume, wonderful selectivity. It amplifies distant stations to the volume of local ones.

8 MATCHED TRANSFORMERS, \$35.00



Branston Kit No. R-199. 3-stage long wave R. F. Transformer \$13.50, Twin A. F.'s \$8.00, Single Stage Long Wave R. F. \$4.50, Long Wave Tuned R. F. \$4.50, Special Tuned Coupling Transformer \$4.50, Short Wave R. F. \$4.50. (Sold separately if desired.) All matched and given operation test.

With our clear and complete instructions you can easily build a set to equal this,—a better set than you could buy for a lot more money.

Send for Blueprints and Catalogue

Send 25c in coin or stamps for complete blueprints and layout covering Super Heterodyne, Radio Frequency and Honeycomb Coil Circuits; also complete catalogue of Branston Quality Radio products.

Your dealer has Branston Kits or can get them for you.

Chas. A. Branston, Inc.
813 Main St., Buffalo, N. Y.

Manufacturers of Branston Violet Ray High Frequency Generators

In Canada—Chas. A. Branston, Ltd., Toronto, Ont.

5-TUBE LOW-LOSS WONDER!!

Build this wonderful set and note the vast difference. Construction very simple. It is self-balancing and non-radiating; with range practically unlimited on a loud-speaker. Simple to operate. Can be operated either on storage or dry batteries. Kit contains: 3-Type F24 Low-Loss Transformers (Zig-Zag wound); 3 Low-Loss Condensers and wiring diagram. Satisfaction guaranteed.

\$12.50 per kit

Federal Radio Products Co. 712 Broadway, Schenectady, N. Y.

RADIO BARGAINS

Radio Set Complete, with R.C.A. tube Batteries and Antenna Equipment, ready to tune in	\$19.85
Journal Low-Loss Coils, set	3.95
Engraved Binding Posts, Complete Set	1.00
Guaranteed Crystals59
Famous Chapin Transformers, 6-1 or 3-1	3.85

All mail orders filled promptly, C. O. D., Parcel Post

FREE—Write for Big Bargain Sheet

Radio-Electric Mfg. Co., Dept. 2, 442 Clinton Ave., Newark, N. J.

"HERCULES"

★ Aerial Mast

All Steel Construction

To-day, anyone may have an aerial mast of sufficient height to get coast to coast reception. A mast that is ideal for both receiving or transmitting. This mast is painted black and is furnished complete with galvanized steel guy wires and galvanized masthead pulley and complete erection diagram. You have no extras to buy. We pay the freight. 20' mast \$10. 40' mast \$25. 60' mast \$45. Write for full particulars, literature and

FREE BLUEPRINT

S. W. HULL & CO., Dept. F3
2048 E. 79th Street, Cleveland, Ohio

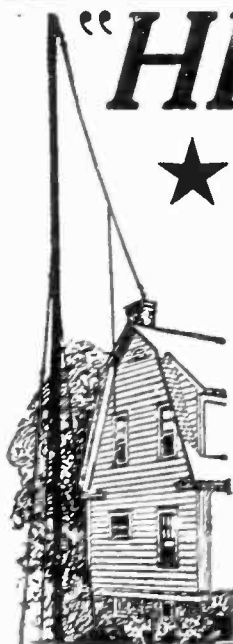

★ Tested and approved by RADIO BROADCAST ★

The Real Secret of Clear Tone and Quiet Operation

told in simple, every-day terms which everyone can understand

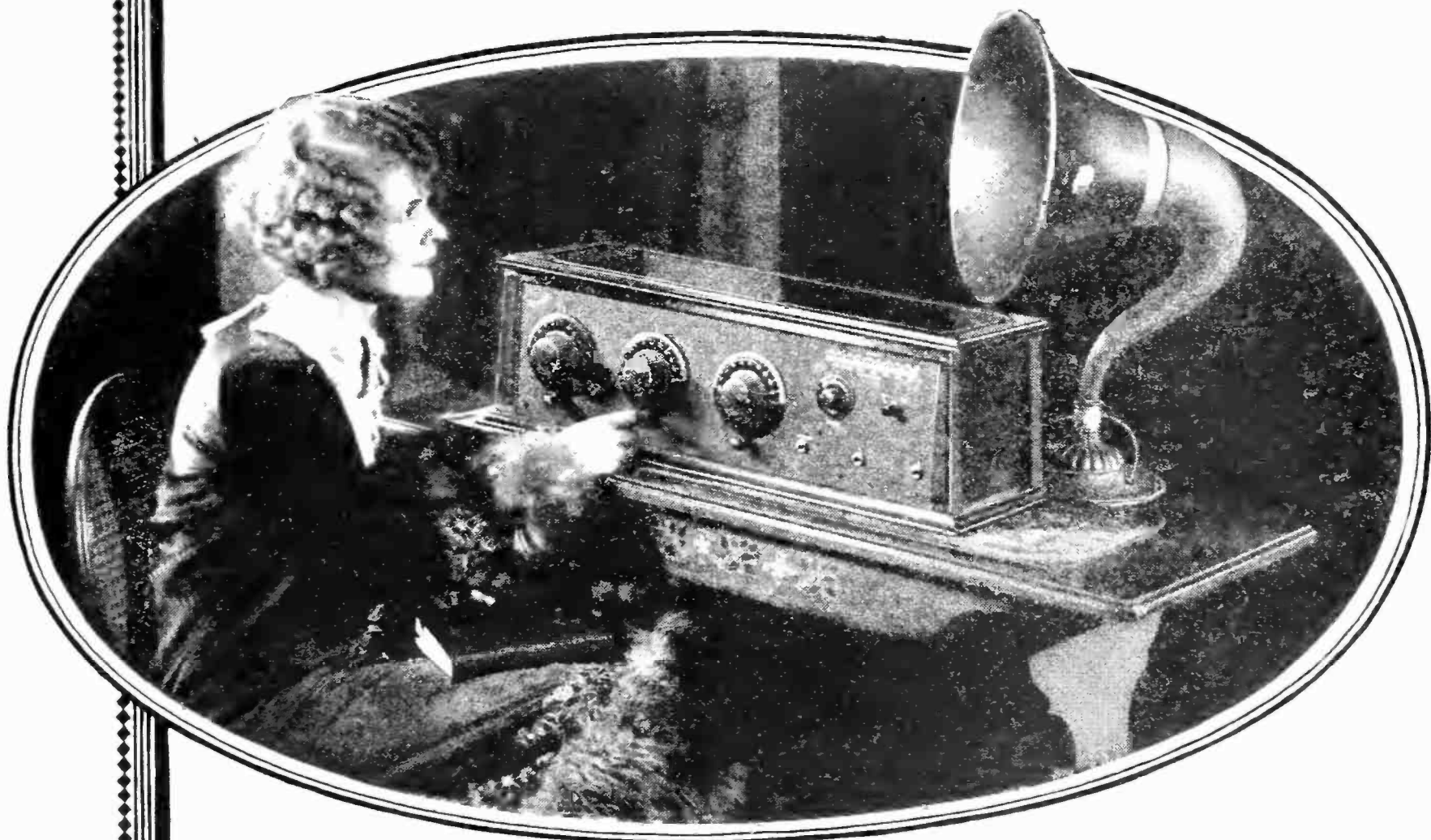

SOMETHING has recently happened to radio which makes it a much simpler, more dependable and sweeter toned instrument. That something is the *complete* elimination of internal noises by the radio inventor, Carl Pfanstiehl.

The technical means which he employed is a scientific story of great interest to radio engineers. The average radio user does not care about that. But, briefly, in popular language, this is what he did:

For years he had observed what complicated devices were being used to neutralize stray oscillations in the set, the oscillations of radio energy which cause chatter and squeaks and squeals, and often distort speech or music. Potentiometers were employed and extra condensers. These are a makeshift. They only partially succeed; and they need adjustment.

He made up his mind that some way could be found to go to the root of the trouble and eliminate it entirely, instead of merely trying to offset it.

By tracing back the oscillations to their separate sources he discovered their true nature and how to keep them out. Nobody had ever known this before.

The remedy is as simple as it is effective. All complicated devices are dispensed with. He so designed the structural relationship between coils and condensers that the stream of radio energy is perfectly controlled; there is no feedback causing stray oscillations. All the radio energy is utilized in developing the true signal. The set is internally noiseless. Speech and music come in without interference. You get a liquid clear enunciation of every syllable and a supremely pure tone.

See and hear this new system that is revolutionizing radio—the Pfanstiehl Model 7—at your dealer's. Or let us send you free descriptive booklet.

Dealers: Write for the special Pfanstiehl proposition.

PFANSTIEHL RADIO COMPANY
Highland Park 23 Second Street Illinois

★ *Pfanstiehl*

MODEL 7 RECEIVER

A 5-tube Receiver using the new system of tuned radio frequency

★ Tested and approved by RADIO BROADCAST ★

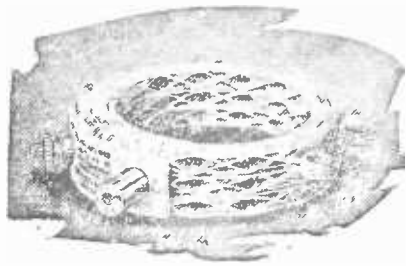

Knockout Reflex Coil No. 8
Price \$1.00 a Pair

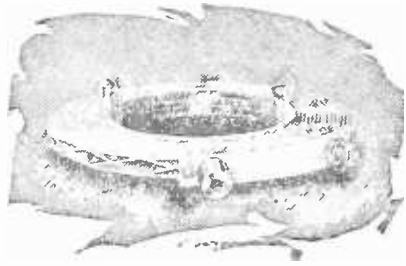

Tuned Transformer Coil No. 14
Price \$2.00

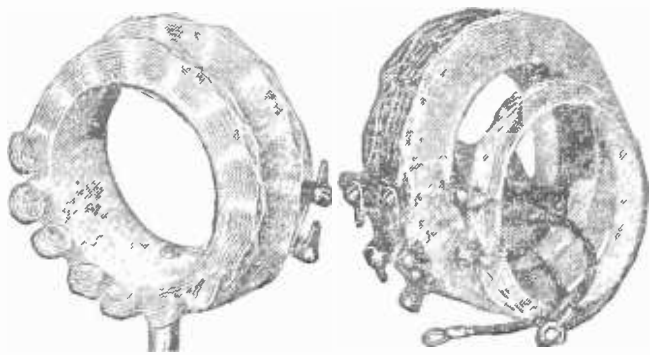

Roberts Circuit Coils, No. 18
Price \$8.00 per set

SICKLES

DIAMOND-WEAVE COILS

Patented Aug. 21, 1923

For The Roberts Circuit

Two units of remarkable efficiency, built specifically for the immensely popular Roberts Circuit. Primary and secondary coils in unit No. 1 are mounted on an insulating sleeve, with the primary coil left free to allow for adjustment in coupling.

Unit No. 2 contains primary, secondary, neutralizing coil, and tickler. The tickler is provided with 180 degree dial control. The tickler is also provided with an additional adjustment of coupling to conform to different characteristics of tubes or variations in plate voltage.

Among other popular Sickles products are the Tuned Radio Frequency Coil for self-neutralizing Tuned Radio Frequency Circuits, and the Knockout Reflex Coils. We manufacture coils for all popular Circuits and for special requirements.

Send for descriptive catalogue

★ **The F. W. Sickles Co.**

335 Worthington Street
SPRINGFIELD, MASS.

ACH TUNING INSTRUMENT

Using Expensive WORM GEAR

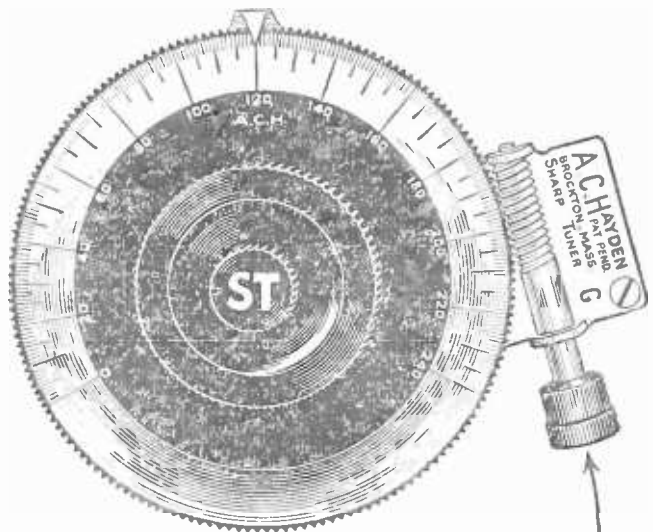

Why the A.C.H. is different

3 in. DIAL → ACH → 156-to-1

4 in. DIAL → ACH → 215-to-1

Price 3-inch size.....\$2.50 Price 4-inch size.....\$5.00
Regular fitting 5/16 shaft. 1/4 and 3/16.....5c each extra

The expensive worm gear is a type of gear in a class by itself. Ask for the

WORM GEAR

A new way to spell

SELECTIVITY—WORM GEAR

A WORM GEAR HAS NO SUBSTITUTE OR OTHER NAME

Mail orders—prepaid U.S.A.—if not at dealers

A. C. HAYDEN RADIO & RESEARCH CO.
BROCKTON, MASS., U. S. A.

You will be satisfied with a "Pacentized" set

THE man who uses Pacent Radio Essentials in building his set has the assurance that he is using the finest parts that engineering skill and trained hands can build.

That this confidence is not misplaced is shown by the fact that over 40 of the leading radio set manufacturers use one or more Pacent Radio Essentials for standard equipment. This shows the leadership that Pacent has attained in the radio parts industry.

Select the parts for the new set you contemplate building from the list given opposite. Get them from your favorite dealer—he carries them or can get them for you.

PACENT ELECTRIC COMPANY
Incorporated
91 Seventh Ave., New York City
Washington Minneapolis Boston San Francisco
Chicago Birmingham Philadelphia St. Louis
Buffalo Jacksonville Detroit

- | PACENT Radio Essentials | |
|-------------------------|--|
| Adapters | |
| Improved Audioformer | |
| Autoplug | |
| Coil Plug | |
| Coil Plug Receptacle | |
| Condensers, Low Loss | |
| Detector Stand | |
| Duojack | |
| Duoplug | |
| Duo-Lateral Coils | |
| Headsets, Everyone | |
| Jacks | |
| Jack Set | |
| Radioloop | |
| Loop Plug | |
| Loop Jack | |
| Multijack | |
| Plugs | |
| Potentiometers | |
| Rheostats | |
| Resistors, Laboratory | |
| Sockets | |
| Twindapter etc., etc. | |



Pacent
RADIO ESSENTIALS

DON'T IMPROVISE — PACENTIZE

★ Tested and approved by RADIO BROADCAST ★

New York Coil Company's Radio Products

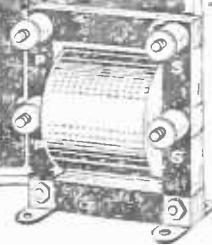
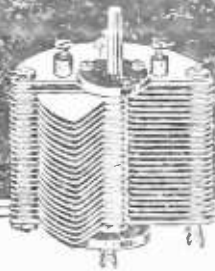
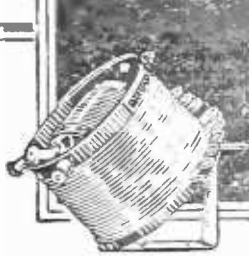

THE SUPREME PLEASURE OF RADIO IS SECURED ONLY FROM A SET CONSTRUCTED BY YOURSELF, BUT BE SURE TO USE RELIABLE PARTS: In THE NEW YORK GROUNDED ROTOR scientific designing, together with the highest grade of materials and instrument workmanship combine to produce a condenser that is in a class by itself—no other condenser manufactured incorporates so many *actual improvements*.

.0005 (23 plate) without Vernier, \$4.50. Geared Vernier attachment complete \$1.50.

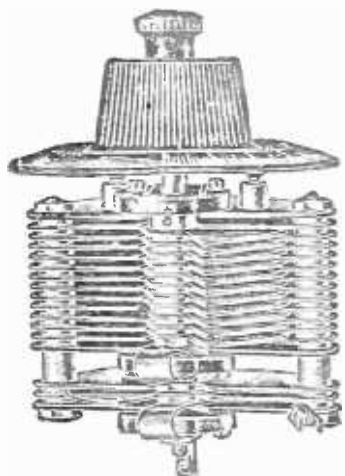
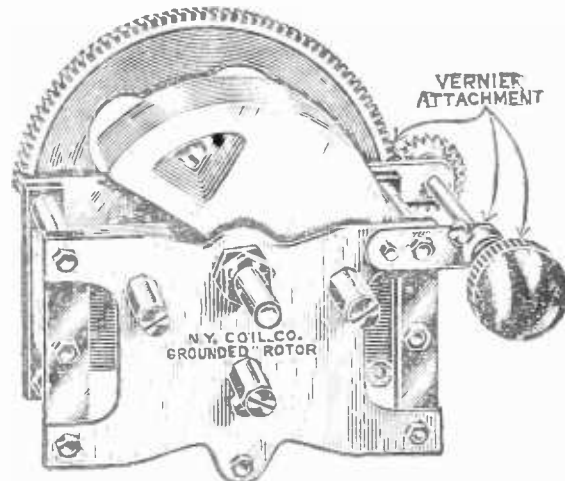

OUR STANDARD NON-GROUNDED CONDENSERS are made in four sizes, with or without vernier, are universally recognized for their efficiency, workmanship and low price—made possible by large production.

Price with Vernier Knob and Dial 23 Plate \$3.50. Without Vernier 17 Plate \$1.80. 23 Plate \$2.00. 43 Plate \$3.00



Type A—No Clips

NEW YORK PRECISION MICA FIXED CONDENSERS add the *real* undistorted tone quality to your receiver—and play a most important point in selectivity, volume, and distant reception. In fact no item used in a Radio Receiver requires more precision and makes use of

such exacting measurements as our Mica Condensers. They are universally endorsed by the leading Radio engineers and most discriminating manufacturers,—yet they cost you no more than the ordinary product.



Type B

NEW YORK COIL COMPANY

338 Pearl Street, New York City, N. Y. ★

PACIFIC COAST MARSHANK SALES COMPANY, 926 Insurance Exchange Building, Los Angeles, Calif., also San Francisco, Portland

★ Tested and approved by RADIO BROADCAST ★

Build that Set! BETTER!



Your set will be thoroughly "professional" in appearance—and will actually operate better—when Stevens "Speed-Up" Tools are used in the making. Designed just for this work, by expert toolsmiths. Speedy—convenient. Amateurs and professionals everywhere enthusiastic.

- 1—SPINTITE WRENCHES. They spin the little nuts on TIGHT, preventing leaks. High grade tools—substantially built for service. Set of 3 most popular sizes for Hex or Round nuts, in box, \$1.00.
- 2—UTILITY REAMER, for bakelite, rubber, etc. Size $\frac{1}{8}$ to $\frac{1}{2}$ in. \$1.50. Size $\frac{3}{8}$ to $\frac{3}{4}$ in. \$2.00.
- 3—OVERSIZE REAMER, for "tight" dials, jacks, etc. In two sizes, $\frac{3}{16}$ and $\frac{1}{4}$ in., each 75c.
- 4—COMBINED DRILL AND COUNTERSINK, 35c.
- 5—RADIO SCRIBER, length $6\frac{3}{4}$ in. 45c.
- 6—PANEL CUTTERS, for bakelite, rubber, etc. Size $\frac{3}{4}$ in., 75c.; 1 in. 85c.; $1\frac{1}{2}$ in. \$1.00.
- 7—BEZEL BEADER, forms beautiful beaded finish in panel holes. Size $\frac{3}{4}$ in. \$1.75; 1 in. \$2.00.
- 8—ADJUSTABLE PANEL CUTTER, for $1\frac{1}{2}$ to 6 in. holes, \$1.75.
- 9—REAMAWL, for starting screws, laying out panels, etc., 35c.
- 10—SCREW CLAMP, for holding screws while filing to size, etc., \$1.50.
- 11—SPEED-A-LOOP PLIERS, for forming perfect loops in bus bar or wires. Complete \$1.50. Attachment only, 50c.

Ask your dealer for these useful tools. If he can't supply you write us direct. Booklet 22 free on request.

Stevens & Co.
Toolsmiths since 1899
375 Broadway, N. Y.

Stevens SPEED-UP Tools for RADIO

POLYPLUG

POSITIVE CONTACT
ALWAYS MAINTAINED

Assuring uninterrupted and clearer reception of programs. All unsatisfactory features of screw type plugs are eliminated. Slip the Polyplug into the socket and you have instant and positive contact. The tension slot, an exclusive feature, makes the Polyplug the most convenient and efficient plug made.

It's Genuine Bakelite Too

Sold by all Dealers ★

75¢
WORTH IT

POLYMET MFG. CORP.
70 LAFAYETTE ST.
N. Y. CITY

NOW -its the "SELF ADJUSTING" RHEOSTAT

No more guessing and uncertainty as to your tube filament voltage. AMPERITE inside your set, one for each tube, automatically gives just the right current to bring the most out of every tube. Simplifies wiring and operation. Increases set compactness. Lengthens tube life. Tested, proved and adopted by more than 50 set manufacturers. The set you buy or build will not be up-to-the-minute in effectiveness without it.

★ **\$1.10 Everywhere**
RADIALL COMPANY
Dept. R.B-3 50 Franklin Street, New York

Write for
FREE
Hook-ups

AMPERITE

REG. U. S. PAT. OFF.

"means right amperes"

★ Tested and approved by RADIO BROADCAST ★

“They did the work!”

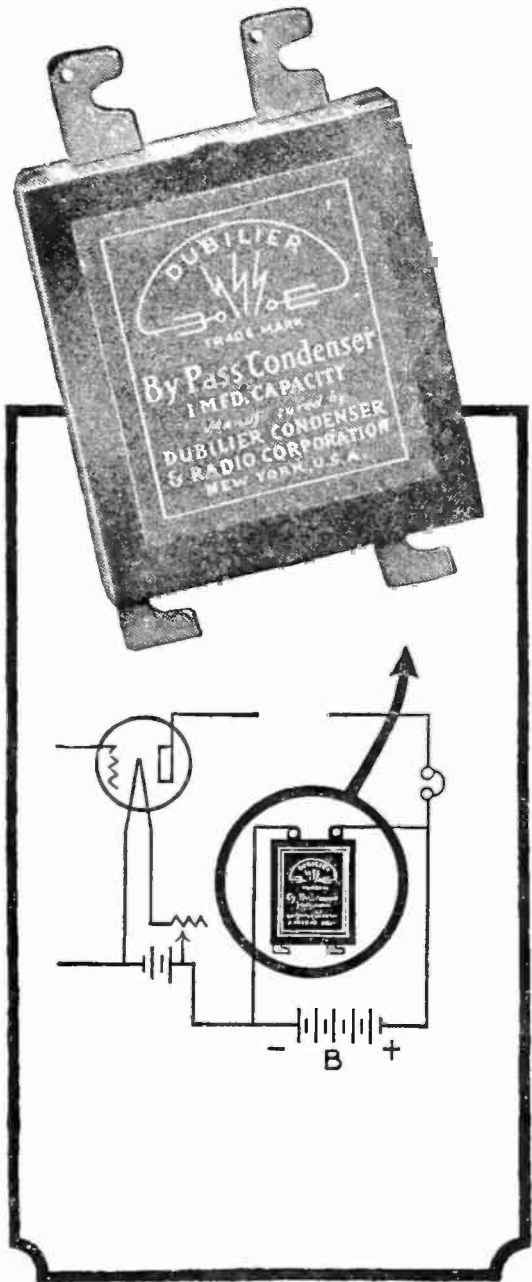

IN SEPTEMBER you advertised a Dubilier By-Pass Condenser to be attached across the “B” battery. As I had three sets of “B” batteries (detector, amplifier, and power amplifier) I purchased and installed three of them. They ‘did the work’ magnificently.

This message came from just one pleased radio fan—but the experience of many others is identical.

AND you, too, will find that a Dubilier By-Pass Condenser in your set will eliminate noises—purify reception—and do the work magnificently!



Dubilier

CONDENSER AND RADIO CORPORATION

★ Tested and approved by RADIO BROADCAST ★

TRIMM

"Concert"

Model No. 80



\$25

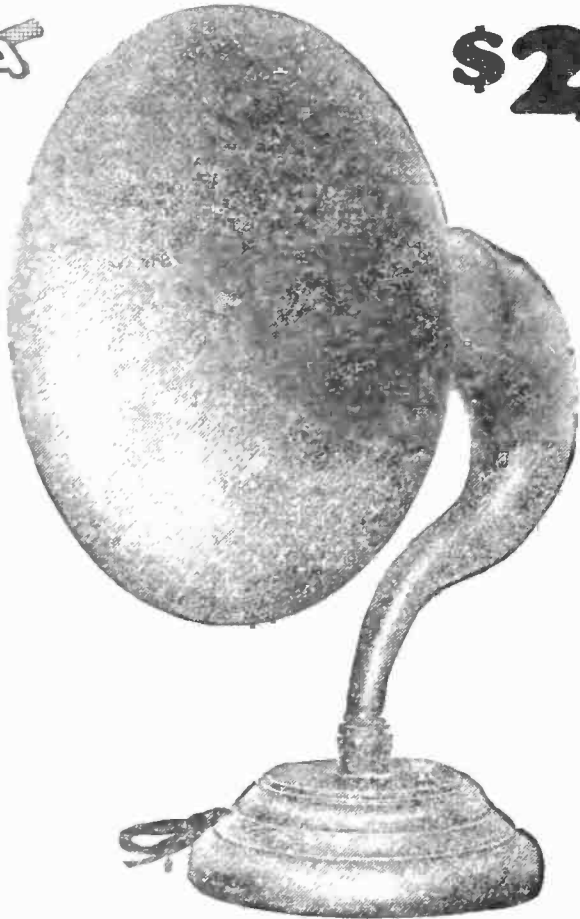

THE SPEAKER that successfully carries the volume of high-powered, multi-stage amplifiers. Extra large diaphragm brings in the low pitched tones of organ and cello so often lost in radio reception.

TRIMM

Superior Reproducers

Headsets

Professional - - **\$7.50**

Dependable - - **\$5.00**

Speakers

Concert Model - **\$25.00**

Home Speaker - **\$10.00**

Phonodapter

GIANT Unit - **\$10.00**

Little Wonder - - **\$4.50**



TRIMM

RADIO MANUFACTURING
COMPANY

24 So. Clinton St.
CHICAGO
U.S.A.

on the dot

It's as easy as placing your pencil point on a town on the map—this tuning in with Apex Vernier Dials.

They make logging a simple matter and "getting a station" positive. The ratio is 12 to 1. Sells in Royal Brass Finish for \$2.00—Satin Silver Finish \$2.50 DeLuxe Gold Plated (24k) \$3.50. Applied to any shaft—quickly.

Apex 7-Tube Microdyne—Super-Heterodyne knock-down sets sell for \$97.50. The Apex Super Five in a Walnut Cabinet is \$95.00. See your better Radio Dealers.

Apex Electric Mfg. Co.
1414 W. 59th St.
CHICAGO

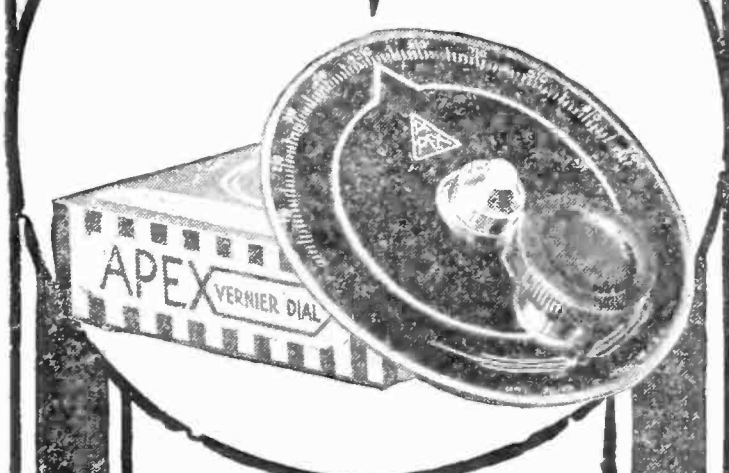

ODD FISH

Being a Collection of London Residents described and drawn by

STACY AUMONIER
and
GEORGE BELCHER

Price, \$2.00

Doubleday, Page & Co., Garden City, New York

★ Tested and approved by RADIO BROADCAST ★

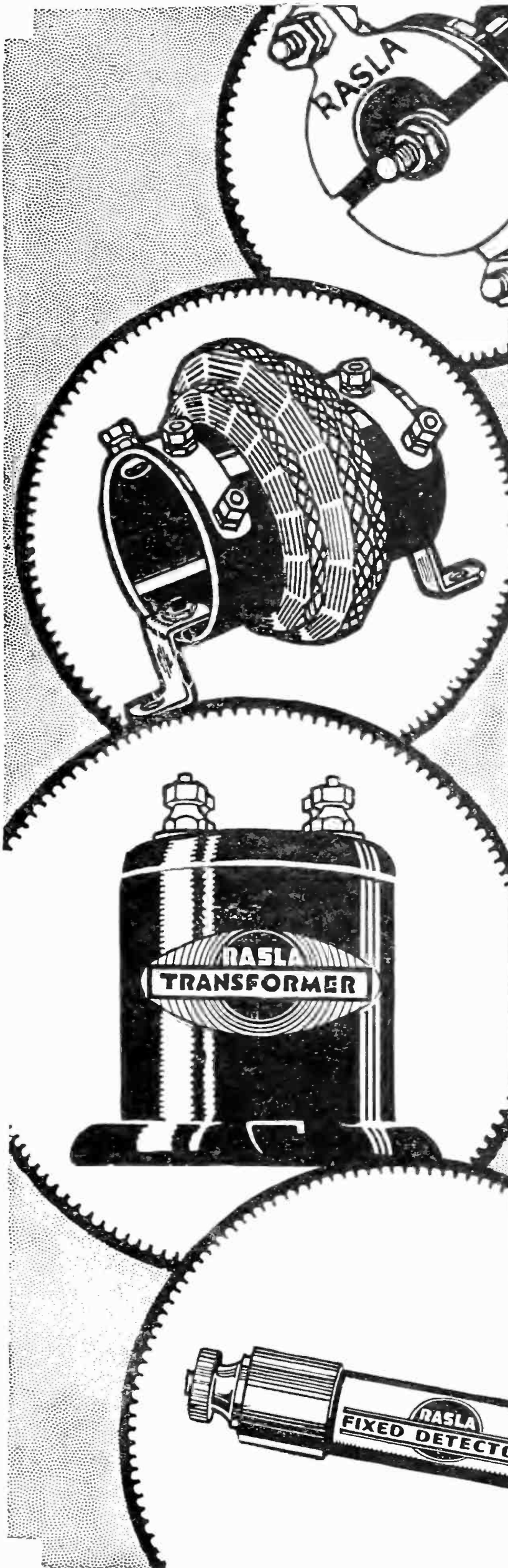

**A Loudspeaker ★
On Two Tubes!**

THE Improved Rasla Reflex for Two Tubes will startle you. You won't believe that such great volume can be gotten from two tubes. You'll marvel at the selectivity and at the distant stations that come roaring in.

The Improved Rasla Reflex is the most powerful circuit so far devised! Never before has it been possible to do with two tubes what the Improved Rasla Reflex can do. You will convince yourself of that quickly.

The Improved Rasla Reflex is easy to build, very easy. The complete wiring diagrams eliminate all chance of going wrong. The four RASLA units pictured make results certain.

Go to your dealer to-day and ask for the Improved Rasla Reflex Construction Bulletins for one and two tubes FREE. If he cannot supply you, write us.

**DAVIDSON RADIO CORP.
222 Fulton St. N.Y.C.**

★ Tested and approved by RADIO BROADCAST ★

TRADE MARK
UNITED SCIEN. LAB.
INC.

★

**LOW-LOSS
CONDENSER**
PLAIN & VERNIER TYPE
PRECISION MOVEMENT, ABSENCE
OF GEARS OR COMPLICATED PARTS

Improved Type **RHEOSTATS**
and **POTENTIOMETERS**
All Sizes



SUPERIOR CONSTRUCTION

GENUINE BAKELITE

DUAL RATIO GROUNDED ROTOR

TRADE-MARK
UNITED SCIEN. LAB.
INC.

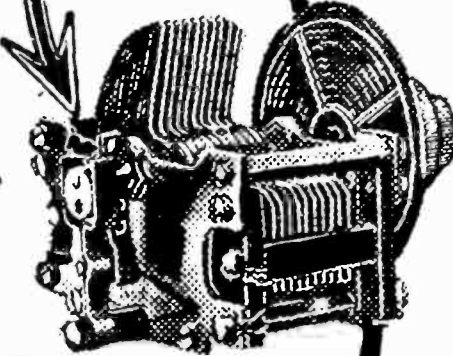
United Scientific Laboratories, Inc.
92-94 E. 10TH ST. NEW YORK CITY

SINGER Compendyne ★



Patents pending

**Get the program
you want
when you want it!**

The Compendyne five tube tuned R. F. low loss receiver has brought in sixty-seven distant stations on the loud speaker, within two and a quarter hours, while powerful local stations were broadcasting. Cabinet and panel are matched in mahogany, engraving and panel parts are gold finish.

The price is now **\$79.00**—formerly \$95.

Write for descriptive literature

E. SINGER COMPANY, 40 Hudson St., N. Y.

W W



★

**A
quality plug
that adds
refinement
to any radio
set**

75¢

EVERYWHERE

The original Weston Radio Plug
It has been widely imitated but never duplicated. Experienced radio users who know radio values demand the Weston Plug. Just try one. In a split second, you can hook up headphones or loudspeaker. Contact is sure and perfect. Get one to-day.

Weston Electrical Instrument Co.
179 Weston Avenue Newark, N. J.

WESTON

Electrical Indicating Instrument Authorities Since 1888

STANDARD - The World Over

★ Tested and approved by RADIO BROADCAST ★

The Question of B Battery Current Has Been Solved with the Trans "B" former

The *Kellogg* Trans-B-former furnishes the necessary plate voltages for your radio set, from your 110AC, 60 cycle, electric light socket without any interferences.

This unvarying current is furnished at less than one-fifth cent per hour. Throw away your "B" batteries and install a Trans-B-former and your set will operate at maximum efficiency constantly.

The *Kellogg* Trans-B-former will:

- Improve reception.
- Reduce operating cost to a minimum.
- Add to the appearance of your set.
- Increase DX possibilities.

Developed, perfected and guaranteed by the Kellogg Switchboard and Supply Company.

At Your Dealers

Each\$50.00

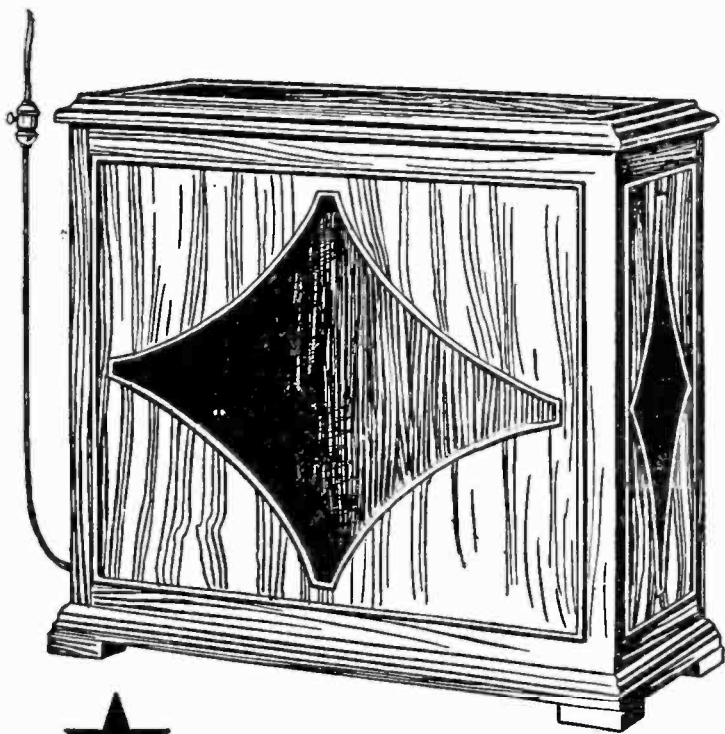

KELLOGG SWITCHBOARD & SUPPLY CO.

1066 WEST ADAMS STREET, CHICAGO

★ Tested and approved by RADIO BROADCAST ★

Jiffy RIBBON ANTENNA First For Reception

Tremendously increased range and power are yours from the moment you install a Jiffy Ribbon Antenna. Far distant stations—programs—hitherto beyond your range, are quickly, surely reached with this exceptionally efficient aerial.

Jiffy Ribbon Antenna is winning enthusiastic public favor everywhere. It is not a copper aerial—thus is immune to oxidization and is guaranteed absolutely non-corrosive. It has great tensile strength—will not kink or curl and remains bright and clean month after month.

Enjoy full reception and absolute efficiency from your set by equipping it with a Jiffy Ribbon Antenna.

Comes in 100 foot lengths complete with 2 insulators ready for installation



\$1.50

Most good dealers carry Jiffy Ribbon Antenna. If yours cannot supply you—order direct.

Mail To-day

APEX STAMPING CO.
Dept. 43, Riverdale, Illinois

Send me Jiffy Ribbon Antenna. I agree to pay postman \$1.50 each, plus few pennies postage.

Name

Address

FREE To Each Purchaser of a World Battery



A 24-Volt "B" Storage Battery positively given FREE with each purchase of a WORLD "A" Storage Battery. The WORLD Battery is famous for its guaranteed quality and service. Backed by years of Successful Manufacture and Thousands of Satisfied Users. You save 50%.

Prices That Save and Satisfy	
AUTO BATTERIES	RADIO BATTERIES
6-Volt, 11 Plate \$12.25	6-Volt, 100 Amps. \$12.50
6-Volt, 13 Plate 14.25	6-Volt, 120 Amps. 14.50
12-Volt, 7 Plate 17.00	6-Volt, 140 Amps. 16.00

Shipment Express C.O.D. subject to examination. 5 per cent discount for cash in full with order.

2-Year Guarantee Bond in Writing With Each World Storage Battery

proves satisfactory World performance. Mail your name and address—we will ship battery day order is received; and give you your choice of "B" Storage Battery or a handsome nickel finish Auto Spotlite, FREE. Write TODAY

WORLD BATTERY COMPANY
1219 So. Wabash Ave. Dept. 24, CHICAGO, ILL.

This FREE "B" Storage Battery takes the place of dry cell "B" batteries. Can be recharged and will last indefinitely. To be sold retail for \$6.00. It is the only battery of its kind equipped with solid rubber case—and insurance against acid and leakage. Take advantage of this remarkable introductory offer NOW. (To those who prefer it, we will send FREE a handsome nickel finish Auto Spotlite, instead of the "B" Battery. Be sure to specify which is wanted.)

GIVEN FREE
To introduce this new and superior World "B" Storage Battery to the Public

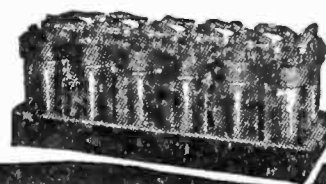

Are you looking for trouble?

If it is in your "B" Batteries you can locate it with a

SAMBER VOLT METER

\$1.00

Post Paid Anywhere

Send Check or Money Order

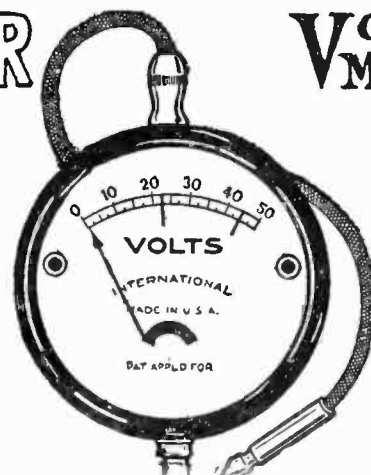

\$1.00

10 to 50 Volts

Nickel Plated

SAMBER RADIO PRODUCTS CO.
27 School Street Boston, Dept. A

★ Tested and approved by RADIO BROADCAST ★

9600 MILES WITH B-T LOW LOSS SW TUNER

B-T LIFETIME CONDENSERS

Type	M. M. F.	Price
L-7	125	\$4.25
L-11	250	4.50
L-23	500	5.00
L-35	750	6.50

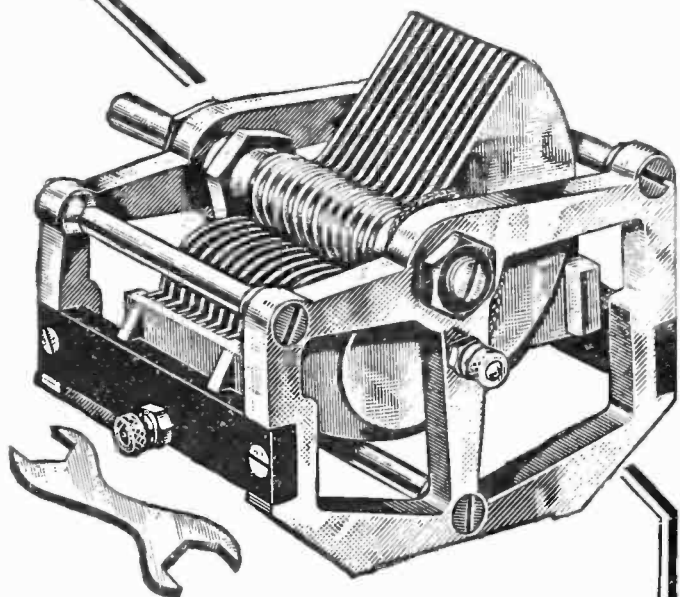

Radio 2WR, Arthur G. Wester, Assistant Division Manager of the American Radio Relay League wrote us as follows—"Having obtained one of your Short Wave Tuners, I would like to mention some of the results obtained. New Zealand 4AA on 80 meters was copied on November 13th steadily from 6:16 to 6:39 A.M., E.S.T. The estimated distance is 9600 miles. Mexican BX was worked from this station on November 15th and not one word was missed. Numerous other stations from all over the United States have been copied."

R. A. Bradley, Technical Editor of Wireless Age, says—"The results obtained with your Tuner (type B) and Transformer (type AC-3) have never been equalled by myself nor any of my associates. The adjustable coupling on your Low Loss Tuner is the most valuable thing that has ever been added to the regenerative type tuner." (See Wireless Age, December, for hook-up, or write us.)

Don't fail to see the B-T Low Loss Parts at your dealer's! Our 40 page book, Better Tuning, contains details, hook-ups, construction, tuning and general information. Sent postpaid for 10c.

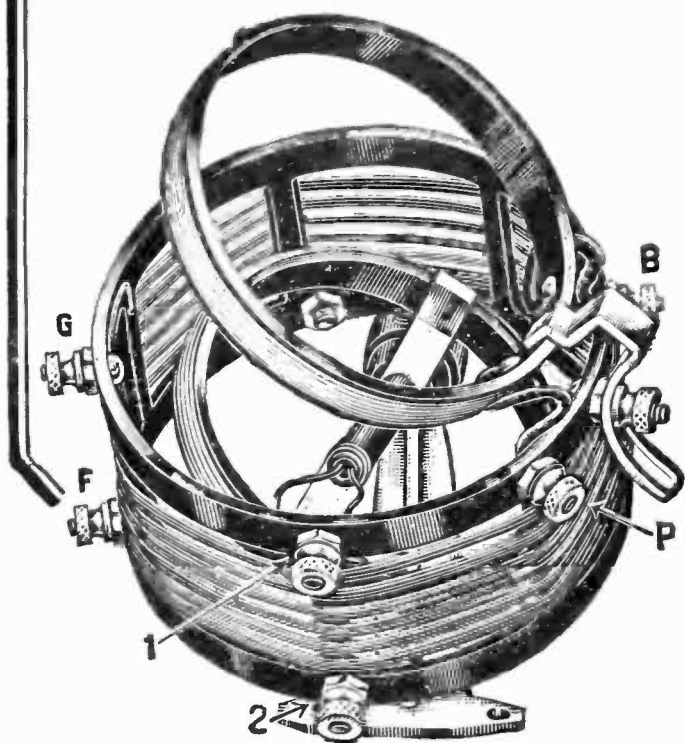

B-T LOW LOSS TUNERS
Made for Broadcast and Short Wave work. Ranges covered with L-11 Lifetime Condenser.
Type B 200 to 565 \$5.00
Type SW 50 to 150 5.00

Bremer-Tully Mfg. Co.

"Pioneers of Better Tuning"

532 S. Canal St.

Chicago, Ill.

★ Tested and approved by RADIO BROADCAST ★

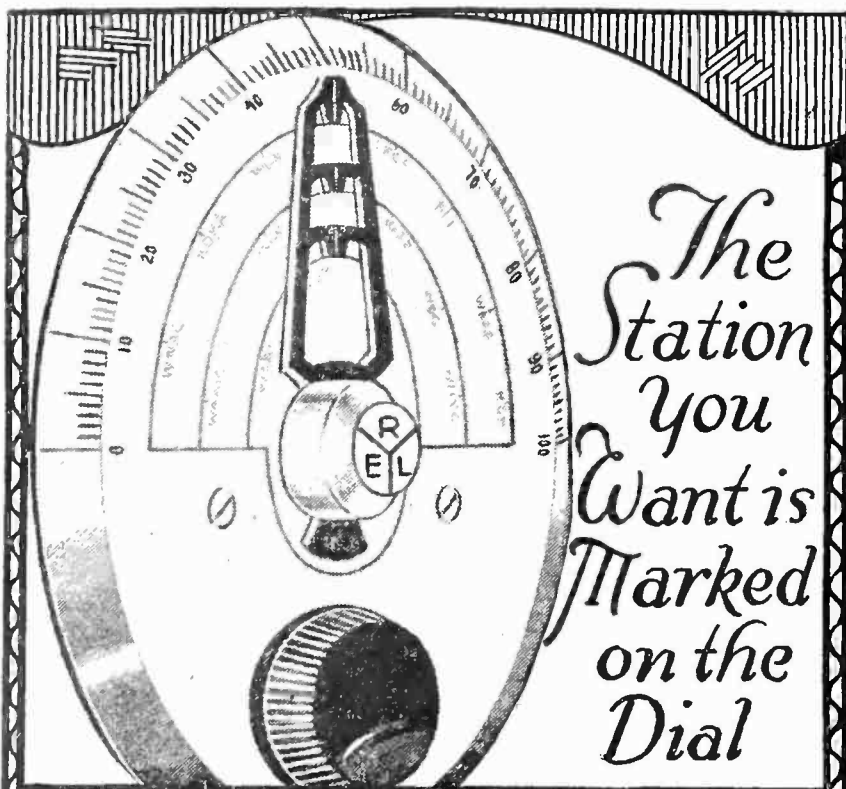

The Station You Want is Marked on the Dial

Direct Tuning



Designed by R. E. Lacault, E. E., A. M. I. R. E., inventor of the famous Ultra-dyne circuit. This monogram seal (R. E. L.) is your assurance of Lacault design

Stop fishing for your favorite station. *Select* the program you want—get it lightning-quick. Replace your old dials with ULTRA-VERNIER Tuning Controls. Then, when you have tuned in a delightful station, pencil-record it on the dial. Never again need you guess or fumble for that station, or bother with wave-lengths. Simply turn the finder to your pencilmark, and you hear it!

\$2.50

At your dealers Made by the Hammarlund Mfg. Co., your assurance of quality and dependability—produced solely for the Phenix Radio Corporation.

Should you move—or a station discontinue or wave-lengths change—erase the marks, leaving the dial beautifully clean and new. Thus, you may now have all the joy of radio, with none of the discouragements. Moreover, the ULTRA-VERNIER is a single vernier tuning control.

At your dealer, otherwise send purchase price and you will be supplied postpaid.



ULTRA-VERNIER
TUNING CONTROL
PHENIX RADIO CORPORATION

5-7 Beekman Street
New York City



It Does the Trick!

IT takes a MOUNTFORD Grid Leak to bring out the best qualities of any radio set—richness of tone—selectivity—volume—and distance.

MOUNTFORD Grid Leaks are guaranteed *moisture-proof, noiseless and accurate!*

Important! The MOUNTFORD process of securing terminals under pressure assures the perfect vacuum so essential to best results.

MOUNTFORD Grid Leaks are made in any resistance, and in two styles—the regular MOUNTFORD, standard for years, and the attractive MOUNTFORD DE LUXE.

Sold to Distributors and Manufacturers Exclusively

Ask your dealer, or write direct—

C. E. MOUNTFORD
465-467 Greenwich Street New York
Manufacturer of
GRID LEAKS



Over a Million in Use

★ Tested and approved by RADIO BROADCAST ★

Write today for your **FREE** copy of—

Ward's New Radio Catalogue

THIS advertisement is published to tell you three things that everyone interested in Radio *should know*.

That we believe Ward's is today the greatest Radio store in the world—that it is the real Headquarters for Radio.

Second, that at Ward's you can buy everything in Radio without paying the usual "Radio Profits."

Third, that this big 68-page book—a genuine reference book on Radio—is yours free for the asking.

Our Radio Experts

This Catalogue is a book gotten up by experts. It shows all the best hook-ups, everything in parts and

complete sets—so simple that you yourself can easily install them.

And it shows only tested and approved Radio equipment—selected and tested thoroughly by our Experts who are up-to-the-minute in Radio.

Write for Ward's free 68-page Radio Catalogue and see the low prices.

Our 53 Year Old Policy

Every Radio set we sell is guaranteed to give complete satisfaction. In buying Radio from Ward's you are buying from a house whose reliability is above question. For 53 years we have sold quality goods only. Address our house nearest you. Dept. No. 27-R

Headquarters for Radio

*Satisfaction Guaranteed
or Your Money Back*

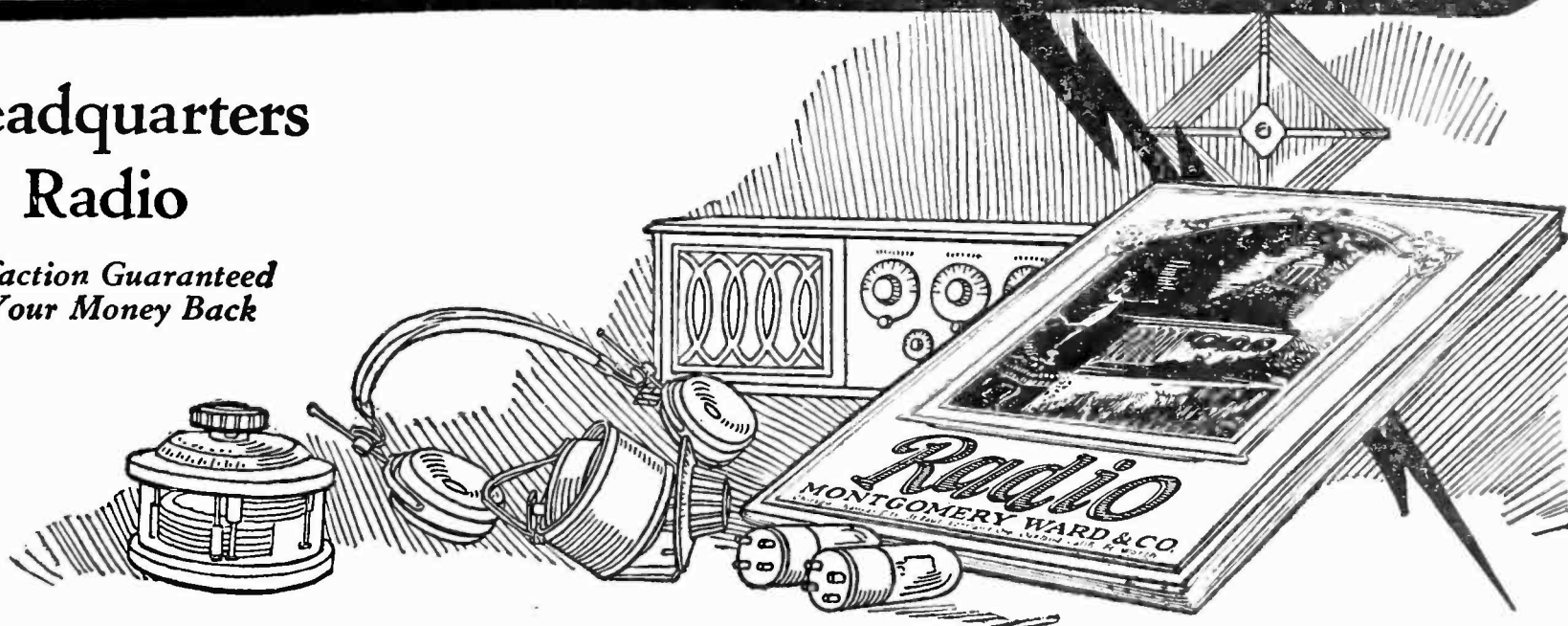

ESTABLISHED 1872
Montgomery Ward & Co.

The Oldest Mail Order House is Today the Most Progressive

Chicago Kansas City St. Paul Portland, Ore. Oakland, Calif. Fort Worth



Set--Six

Radio Socket Wrench

\$1.25

A solidly-built wrench for every radio need. Reaches and fits every round and hexagon nut on any set; works with a fast, screw-driver turn. Compact, light, and handy.

*If your dealer cannot supply you
order from us*



THE PERRY-FAY COMPANY

Screw Machine Products

ELYRIA, OHIO

BLUEBIRD RADIO TUBES

Distinctly New

AND EFFICIENT, satisfying every radio fan's wish in performance and price. Our direct sales plan enables us to sell at this low figure. "Bluebird" assures increased range and undistorted volume.

Type 400—5 Volts, 1 Ampere Detector Tube.

Type 401A—5 Volts, .25 Ampere Amplifier and Detector.

Type 499—3.4 Volts, .06 Ampere Amplifier and Detector.

Type 499A—3.4 Volts, .06 Ampere with Standard Base Amplifier and Detector.

Type 412—1½ Volts, .25 Ampere Platinum Filament Amplifier and Detector.



All Standard Types \$2.50

TYPE 402 5 WATT TRANSMITTERS . . . \$3.00

EVERY TUBE GUARANTEED

to work in Radio Frequency. Especially adapted for Neutrodyne, Reflex and Super-Heterodyne Sets.

Shipped Parcel Post C. O. D.
When Ordering Mention Type

BLUEBIRD TUBE CO.

200 Broadway

New York City

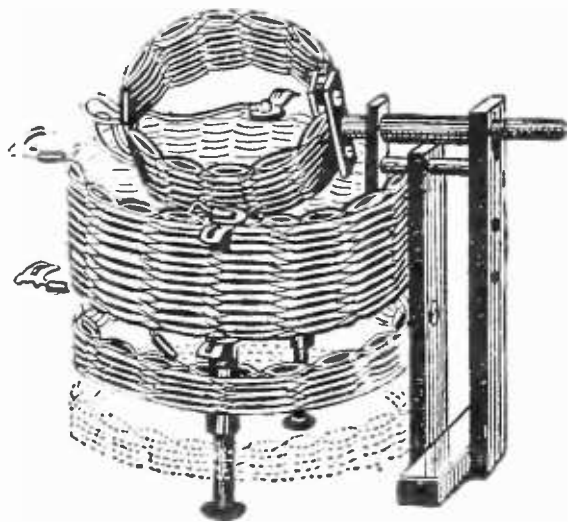

Reg. U. S. Patent Office

**For Sensitivity—
Selectivity—
Distance**

Transcontinental Low Loss Tuner

You love to labor—then make the most of it. To just build a radio set is not sufficient—the receiver you labor on should be the best.

Many radio fans using the Transcontinental Low Loss Tuner report having heard European Stations during the International Test Week. These remarkable 3-circuit tuners can be purchased at any good Radio Store.

List Price, \$7.00

Jobbers and distributors wanted

TRANSCONTINENTAL SALES CO.

241 Market St.

Newark, N. J.

ALL SHOT That's the common expression of dry cell "B" batteries. Purchase the economy way and enjoy freedom from hissing and frying, clearer reception, and greater volume. Put together an everlasting "HAWLEY" rechargeable "B" storage battery. Nickel-iron alkaline type. No former experience or soldering necessary. Put up in both assembled and knock-down types. The knock-down units contain all actual material for building battery and are put up in 90 volts at \$8.95; 100 volts at \$9.95; 120 volts at \$11.60; 135 volts at \$12.75; 150 volts at \$13.90; 200 volts at \$17.50. Guaranteed for 2 years with a 30 day trial offer of complete satisfaction or return of your money without any ifs nor ands. Complete sample cell 35c prepaid. 8 page illustrated folder of instructions showing simple putting together, making charger and charging free with all orders. Complete manufactured "B" battery charger \$2.75. Order direct or write for my literature, guarantee, and testimonials. Same day shipments. Address

B. F. SMITH

31 Washington Ave.

Danbury, Conn.

FREE APPLAUSE CARDS A generous supply sent upon request. Mail Order Headquarters with personal service on Complete Sets—Kits—Parts and Supplies. Quality merchandise at right prices. All shipments prepaid. Write for complete information and free applause cards.

G. EVERETT MARSH

5207 Dorchester Ave.

Chicago, Ill.

Read RUDYARD KIPLING'S Books

For sale everywhere

Doubleday, Page & Co.

Radio Salesmen and Set Builders

We need you and you need us. If you are reliable and well known in your community, we will appoint you our representative and furnish you with standard well advertised sets and parts at prices that will enable you to sell at a handsome profit. Write at once for catalogue and sales plan. Waveland Radio Co., Div. 41, 1027 N. State St., Chicago, Ill.

Wait ~ till you've heard the Garod



Is there a best radio receiver?

Only deliberate comparison of various receivers can determine. Noises once thought inseparable from radio *must* tune out. The ideal receiver is a musical instrument when music is desired. And the voice of the singer....near or far....must be as rich in charm as in actuality. Wherever the test of hearing includes the Garod Neutrodyne the choice is always Garod • Distant programs are not distant to the Garod....even when local stations are broadcasting • Its vast reserve of power is controlled by a single, simple dial • Go to the Garod dealer and ask for the Visitor's Hearing. It will mark the end of your seeking....the end of your quest for the best in radio achievement • And the man who selects a Garod need not pay for it all at once. Any dealer will explain the details of the unique payment plan.

Send for a copy of
interesting booklet
"How to Select a
Radio Receiver"

Garod Corporation
120 Adams St., Newark, N.J.



Canadian Distributors

Continental Equipment Co., Ltd., 357 St. Catharine St., West, Montreal

GAROD
NEUTRODYNE



★ Tested and approved by RADIO BROADCAST ★

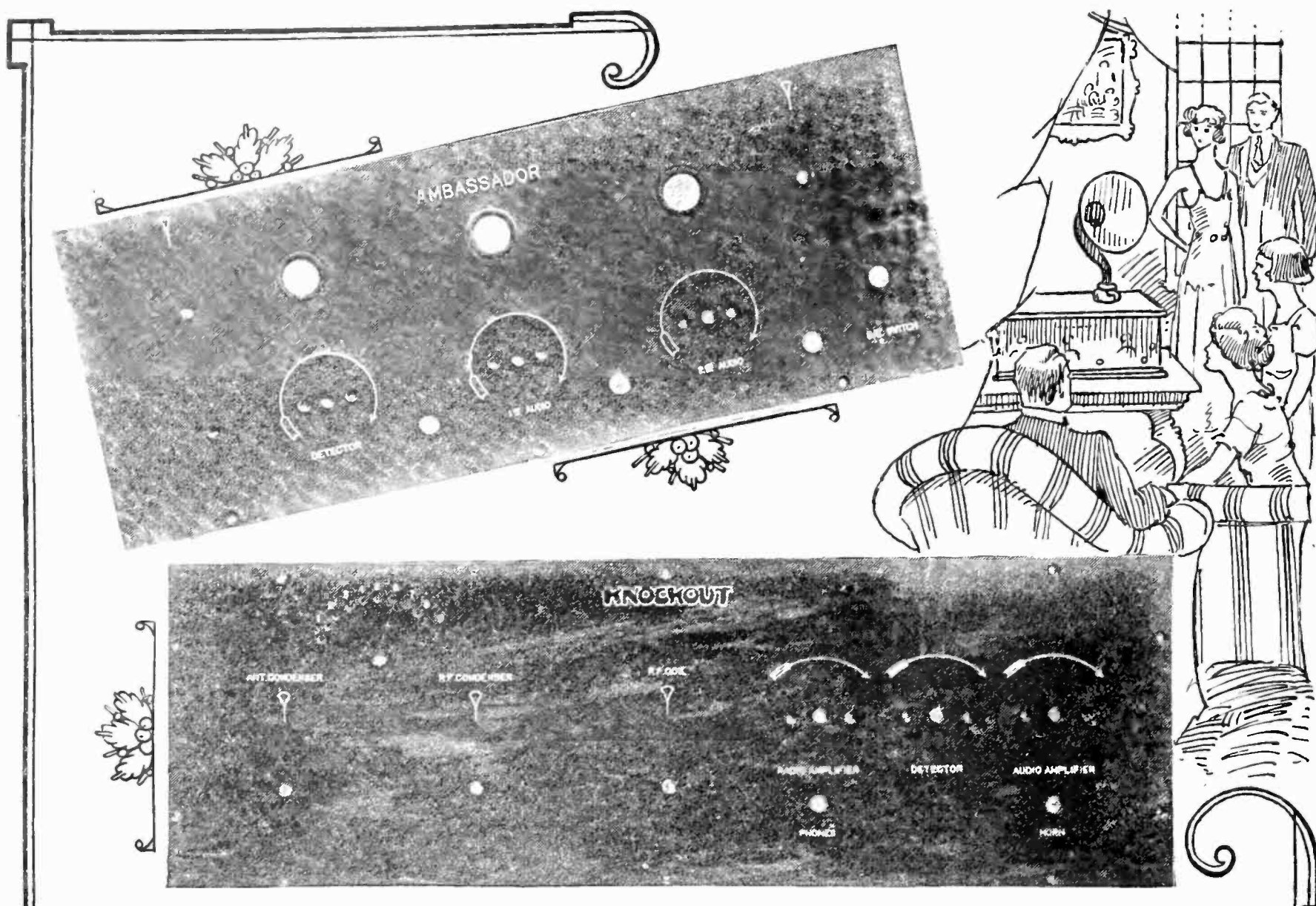

INSULINE PANELS

Fulfill Every Radio Requirement!

No matter what radio set you have you cannot have proper radio reception unless your set is built with perfect insulating panels.

Take Insuline panels for example. Thousands of dealers are selling Insuline panels to-day. It is being used by the leading manufacturers of the country. It has been endorsed by millions of radio fans, Why?

Because Insuline embodies all the panel qualities radio experts say are necessary to perfect reception. Impervious to changing weather conditions, moisture proof, of colossal dielectric strength. Insuline stands to-day as the pride of the radio industry.

Insuline comes in three beautiful finishes—black, black anti-capacity, mahogany—and the new frieze finish. In all standard and special sizes. Drilled and engraved for all the well-know circuits.

For panels, dials, tubing, sockets, and mounting strips, insist that your dealer gives you INSULINE.

RADIO PANEL and PARTS CORP.

(INSULATING COMPANY OF AMERICA)

Insuline Building, 59 Warren Street, New York City



Western Division
Insulating Co. of America
Madison, Wisconsin
538 So. Dearborn Street,
Chicago, Ill.

Sales Representative
F. A. Krue, Jr.
333 State Street,
Detroit, Michigan

Manufacturers, Jobbers and Dealers Write Our Nearest Branch for Booklet and Prices

★ Tested and approved by RADIO BROADCAST ★

From \$22⁰⁰ a Week Clerk to \$85⁰⁰ Radio Expert

How a young man discovered his opportunity in a fascinating new field, and quickly prepared himself in his spare time for the position he wanted. As related by himself.

"I was interested in radio from the very beginning. I bought a little one-tube set when radio first became popular and I experimented with it, bringing in snatches of song from the air and trying to get distant stations. But my set was very much of a mystery to me. Like most people, I knew how to use it, how to tune in on local stations, but I did not understand how it worked. I often wondered.

"At that time I was working as a clerk in a large mail order house. I took the position because I thought it would be a stepping-stone and that I would quickly advance to something bigger. But years went by—and I was still a clerk. Somehow I had fallen into a rut, and there I remained. I used to get terribly discouraged at times, and I wondered what my future would be. Would I never be anything more than just a clerk?

A New Industry

"Then came the big radio boom, and everybody began talking about the wonderful new industry. Half the people in our town bought receiving sets. On the trains I heard nothing but radio gossip, and the newspapers were crowded with news on radio development. I had a sudden idea—an inspiration.

"Here was an industry that was still an infant compared to other industries. It was young and fast-growing, and evidently would some day be one of the greatest industries in the world. Surely in so new and important an industry there must be big opportunities for beginners—a rare chance for quick success and rich rewards. I would get into the field at once, start at the bottom and grow up with it! I would get out of the rut into which I had fallen, into a new field ripe with opportunities!

"But how? I had to depend too much upon my \$22.00 a week to give it up. If only I could study radio at home in my spare time, and prepare myself for a radio job without giving up my regular work. I decided to make inquiries, and discovered that just such a course was offered by the National Radio Institute in Washington. I enrolled, keeping it a secret from everyone at home.

"For several months I studied at home, in the evenings and whenever I could spare a half-hour or so. The time passed quickly because it was so fascinating. In a few months I had mastered what I had believed 'the mysteries' of radio, and was qualified to take a position in charge of a radio department in a large wholesale house.



"How surprised everyone was when I announced calmly—and I'll admit a little proudly!—that I had graduated from the National Radio Institute and that I had

my certificate as a radio-trician. They were even more surprised when I told them that the Institute had found a position for me right in my own town at \$50.00 a week! They all wanted to know how I did it—and some of the fellows were mighty jealous.

I Earn Big Money

"Advancement came quickly, and now I am a radio engineer earning \$85.00 a week. I expect another promotion soon and it will not be long before I am earning \$100.00 a week.

"I am glad to write this story for publication because the National Radio Institute alone has made my success possible. It offers an absolutely complete course now being given which qualifies you for the Government first-class license and for the big-pay jobs in Radio. I would advise anyone who is interested in radio as a profession to use this coupon and send at once for the valuable information that is offered free. Don't hesitate to use it—there is no obligation. I, too, sent off for the free information before enrolling. Why don't you do it—now?

SPECIAL OFFER

"A special reduced rate is being offered to those who mail the coupon AT ONCE. Get in on the ground floor and save money. Just address the National Radio Institute, Dept. 31DB, Washington, D. C."

NATIONAL RADIO INSTITUTE
Dept. 31DB, Washington, D. C.

I am interested in radio as a profession. You may send me, free and without obligation, your interesting little book "Rich Rewards in Radio" telling about the future of radio, and all information about your spare-time, home-study plan and your free employment service.

Name Age

Address

City State.....

Silver-Marshall, Inc.

RADIO

You can have

LABORATORY AMPLIFICATION CURVES

With your Transformers



McMurdo Silver
Asso. I. R. E.

THE INDIVIDUAL CURVE SHEET REMOVES ALL GUESSWORK

NOW you can obtain the same long-wave transformers that have made the SILVER-MARSHALL 401 unit the choice of engineers, each instrument supplied with its own particular amplification curve.

Think what this means—all the guesswork removed and the success of your intermediate amplifier an assured fact. The curve for each TWO-TEN or TWO-ELEVEN transformer is made under the personal supervision of McMurdo Silver, Asso. I. R. E. Each curve sheet tells just where the transformer peaks, and the exact amplification to be expected in a finished circuit.

SILVER-MARSHALL advanced engineering and production methods now enable you to have the full benefit of measurements heretofore available only in the fully equipped laboratory. The curves enable you to KNOW your transformers.

The TWO-TEN, an iron-core intermediate transformer. Passes 11 kilocycle band without distortion. Peaked at 6000 meters. Provides 1½ to 3½ times the amplification obtainable with any other transformer.

The TWO-ELEVEN, a sharply tuned input or output transformer, peaked at 6000 meters.

Both types in individual aluminum cases. Suitable with any tube in from one to four stages.

Supplied in sets of two or three TWO-TENS and one TWO-ELEVEN, with identical peaks and separate curves for each. Price each, \$8.00.

THE POWER BEHIND THE SILVER SUPER

The intermediate transformer unit type 401, or the TWO-TEN and TWO-ELEVEN transformers are the power behind the receivers described by Mr. Silver in the October and January issues of Radio Broadcast. All parts approved by Mr. Silver in the January number, and used by him, are listed below. Every item is backed by the S-M guarantee of immediate replacement if unsatisfactory.

	Price Each		Price Each
Silver .0005 Low Loss Condensers No. 301	\$ 4.50	Thordarson 3½:1 Audio Transformer	4.00
4" Moulded Dials—Tapered Knobs	1.00	Silver 5-Gang Panel Mounting 199 Socket No. 501	3.00
Howard 6½ Ohm Rheostat	1.10	.5 MFD By-pass Condensers90
Howard 200 Ohm Potentiometer	1.50	.00025 Mica Condensers with Leak Clips45
Insulated Top Binding Posts05	.002 Mica Condensers40
Carter 102A Jack80	.0075 Mica Condensers75
Carter 101 Jack70	.000045 Balancing Condensers	1.50
Silver R. F. Transformer Unit No. 401	14.00	5 Megohm Grid Leak50
(Note:—2 Intermediate Trans. type 210 and 1 Output transformer, type 211, may be substituted at \$8.00 each)		2 Megohm Grid Leak50
Silver Oscillator Coupler No. 101	2.50	7 x 18 x 3/16" Bakelite Panel, Drilled, Grained and Engraved	6.00
Silver 199-Sockets50	7 x 4½ x ½" Oak Base Board, Bus-Bar, Spaghetti, Screws, Nuts, Solder, Flexible Lead Wire	1.25

SEND FOR CIRCULARS ON ABOVE PARTS

FOR THOSE WHO BUILD THE BEST

Low-loss parts designed for maximum efficiency. Used by Mr. Silver in the FOUR-TUBE KNOCKOUT SET. 105 Low-loss coupler, for three-circuit, tuned R. F. or other circuits. Self-supporting coils, with a minimum of dielectric material in the fields. Wave-length range, 200-550 meters with .0005 condenser. Price, \$5.00. 205 Low-loss antenna coil, for tuned R. F. or other circuits. With self-supporting windings. Wave-length

range, 200-550 meters with .0005 condenser. Price \$2.50. 301 Straight-line low-loss, grounded-rotor condenser. Supplied only in .0005mfd. capacity. Price, \$4.50.

THE BOOK

The book "The Portable Super-heterodyne" is a record, in simple language, of Mr. Silver's years of research. Every Fan who means to build a Super should have a copy. Copiously illustrated with detail drawings, diagrams, and photographs. Price, 50c.

SILVER-MARSHALL, Inc.

110 So. Wabash Ave.
CHICAGO ILLINOIS



Eastern Distributor

TWENTIETH CENTURY RADIO CORP.
102 Flatbush Ave. Brooklyn, N. Y.

★ Tested and approved by RADIO BROADCAST ★

For Circuit Supremacy— CIR-KIT and Supereflex

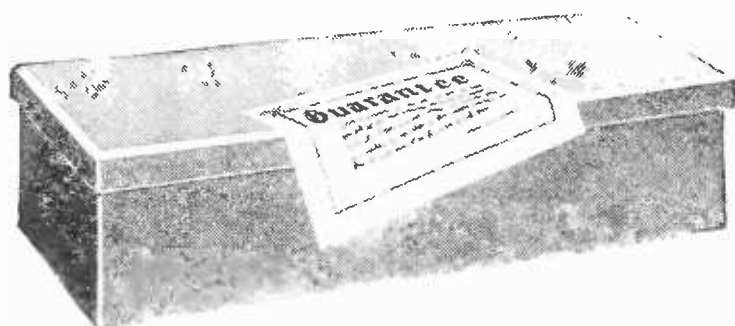

Erla Supereflex—new epoch in circuits. Not just a “wave” of popularity, but the permanence of *basically* superior principles, just as advanced today as when Erla introduced the circuits still rated more powerful, tube for tube.

Expressing the best of Erla science, Supereflex circuits also are so easy to own! Not only because of extreme economy in first cost and operation, but also because Erla *CIR-KIT* enables any experimenter to produce these greater circuits flawlessly. *CIR-KIT* provides every needed item of Erla Precision Radio Apparatus—exclusively responsible for matchless Erla range, volume, clarity, sensitiveness and remarkable ease of control.

CIR-KIT also provides full-size blueprints; stenciled baseboard; and drilled, lettered panel, so that every step must be correct. Assuring lasting supremacy in circuits; the pride of a truly professional hook-up; and incomparable entertainment, *CIR-KIT* is outstanding in radio today.

Electrical Research Laboratories
Dept. B, 2500 Cottage Grove Ave., CHICAGO

ERLA

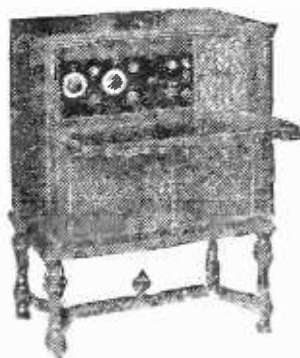

Erla
Floor
Console

Erla complete radio instruments lift radio to the realm of art, with the same superiorities CIR-KIT brings.

Erla Table Cabinet

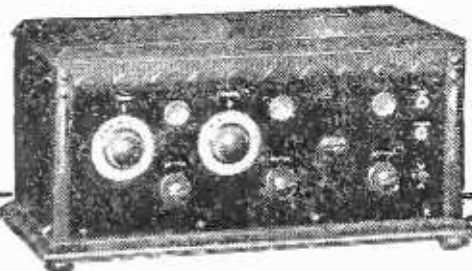

Erla
Table
Console

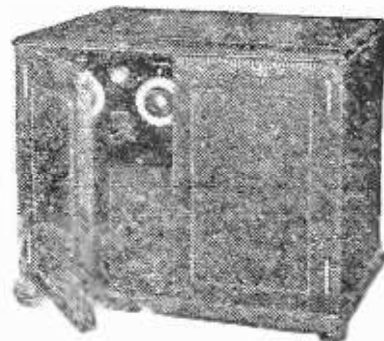

★ Tested and approved by RADIO BROADCAST ★

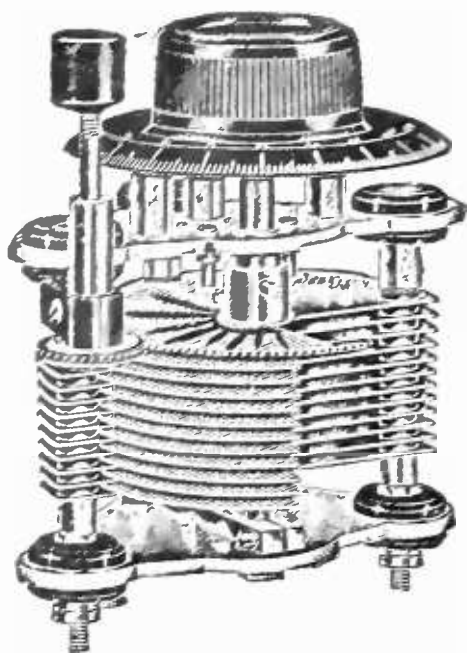

HEATH RADIANT Non-Dielectric CONDENSERS

Used in the

A. C. DAYTON "XL-5"
Radio Set

The A. C. Electrical Co., in designing their *Polydyne Receiver*, looked for the make of condenser which could stand up under all sorts of usage without lessening its efficiency one particle. That their choice was the HEATH RADIANT Condenser bears out the HEATH claim of *permanent efficiency*.

You want to make your new set the best yet—then learn about these "better condensers."

Permanently Flat Plates

Stamped under huge presses to absolute flatness and tempered to prevent warping.

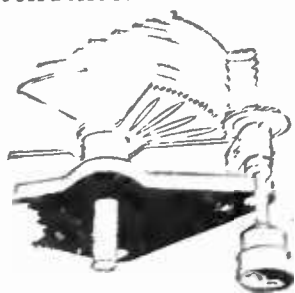

Micrometer Geared Vernier

Ordinary adjustments reduced by separate geared adjustment to hairbreadth distinction. We guarantee the Heath Vernier Condenser to be more highly selective than any condenser employing a vernier which actuates ALL of the plates.

Prices for Vernier Condensers

	With Dial	Without Dial
No. 12AV 12 Plate.....	\$5.00	\$4.35
No. 24AV 24 Plate.....	5.50	4.85
No. 44AV 44 Plate.....	6.50	5.85

Non-Vernier types in all capacities.

Heath Sockets with the Exclusive Shock Absorber Features, 75c Heath Bakelite dial in 2, 3, and 4 inch sizes.

Write for Literature

HEATH RADIO & ELECTRIC MFG. CO.
207 First St. Newark, N. J.

Canadian Distributors:
Marconi Wireless Telegraph Co., of Canada, Ltd.

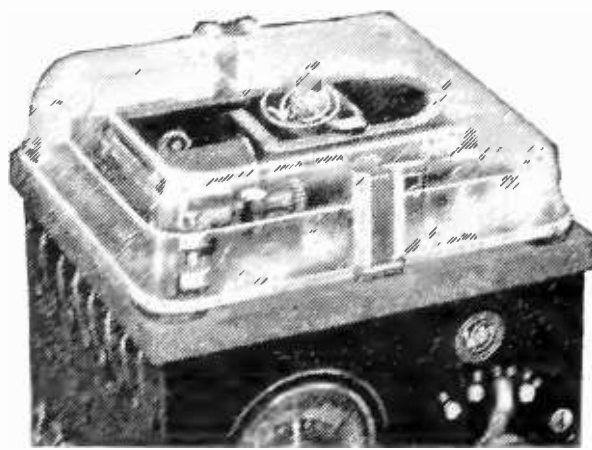

For All Batteries



Valley Battery Charger

For 2-volt peanut tube cells, for 6-volt A batteries and for 24-volt B batteries in from one to four units, the Valley Battery Charger is the only charger which you need.

Plugs into the ordinary light socket like a fan or other household necessity. Just as easy to operate. Takes about a dime's worth of current to bring your battery up to full charge.

Quiet in operation.
Full 6-ampere charging rate.
No liquids. No bulbs.

It has a grained and engraved Bakelite panel which harmonizes with any radio set. Clear glass top shows the simple, patented working parts at all times. Scientifically planned and substantially made by experienced manufacturers of storage battery charging equipment.

At radio dealers everywhere.
Further information gladly furnished on request.



VALLEY ELECTRIC CO.
3157 S. Kingshighway, St. Louis, Mo.

AMBASSADOR Low Loss Products



Master Tuning Coil
Perfectly Balanced Head Phone
Low Loss Condenser

High grade, standard radio products that will increase the efficiency of any set and add to the satisfaction of the user. Ambassador Low Loss Products have long been the choice of particular fans. See them—compare them, and you will choose them too.

At all good dealers. Write for FREE diagrams of circuits in which Ambassador products can be used.



AMBASSADOR SALES COMPANY
108 Greenwich St., New York
326 W. Madison St., Chicago



Everyone Interested in RADIO Should Write for this FREE Radio Book



Write for Your
FREE
copy
to-day

Deal with us and your Radio worries are over. Everything we advertise is *absolutely* legitimate. Our business policy is to sell Honest Merchandise at a low margin of profit. Some friend in your town has bought from "Wholesale Radio." Ask him!

Our Cockaday is Approved
by Popular Radio Lab. and
Lawrence M. Cockaday.

Cockaday 8-Tube Superheterodyne

Parts for Building the Cockaday Eight-tube Superheterodyne Reflex

	List Price
1 General Instrument low-loss condenser (Isolantite insulation) .0005 mfd.	\$ 5.00
1 General Instrument low-loss condenser (Isolantite insulation) .001	6.00
1 Haynes Griffin input transformer (new type)	20.00
3 Haynes Griffin intermediate transformers (new type)]	
1 Precision autodyne coupler	3.50
1 Karas Harmonik audio-freq. transformer	7.00
1 Amplex gridenser .0005 mfd.	1.25
1 Benjamin Cle-ra-tone socket	1.00
7 Federal sockets No. 16	8.40
1 Pacent double circuit jack60
1 Pacent single circuit jack50
2 Na-ald 4 in. dials No. 3043	1.50
1 Amsco Rheostat 2 ohms	1.35
1 Amsco Rheostat 400 ohms	1.50
2 Daven resisto-coupler mountings	2.50
1 Daven grid-leak mounting35
2 Daven resistors .5 megohm	1.00
1 Daven resistor 5 megohms50
1 Daven resistor .005 megohm	1.00
2 Daven resistors .25 megohm	1.00
2 N. Y. mica fixed condensers .0001 mfd.70
4 N. Y. mica fixed condensers .006 mfd.	3.00
1 N. Y. mica fixed condenser .00025 mfd. with grid leak	

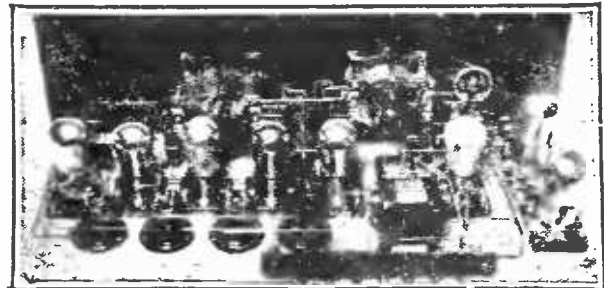

	List Price
mounting45
1 Duratran radio-freq. transformer	4.00
1 Walbert A battery switch50
7 Eby marked binding posts	1.40
1 Bakelite 7x24 highly polished, drilled and engraved panel	8.00
1 Sub-Panel size 1x9—drilled25
1 Set of Popular Radio, three full sized blue prints.....	1.10
1 Box of assorted screws, nuts, washers, lugs, etc50
40 ft. bus bar wire75
1 Baseboard50

OUR KIT PRICE, POSTPAID, \$65.00

Complete Parts for the New Cockaday 5-Tube Set

4-Circuit tuner with resistance amplifier. Every part exactly as specified and approved by Mr. Lawrence M. Cockaday, including

drilled and engraved panel—no extras to buy—everything needed is included. Positively no substitutes \$52.50

Roberts 4-Tube Knock-Out Receiver

	List Price
1 7x21 Drilled and Engraved Panel	\$ 4.00
1 Baseboard60
1 Set of Roberts Nazeley Coils	8.00
2 Triangle Low Loss grounded rotor Condensers .0005 Capacity	10.00
1 Dubilier .00025 Grid Condenser with grid leak mounts..	.40
1 Daven or Electrad 2 meg. leak50
1 Dubilier Mica Condenser .0025 mfd.40
1 Dubilier Mica Condenser .005 mfd.60
1 Fada type Neutralizing Cond.	2.00
3 Pacent 20 ohm rheostats	3.00
4 Bestone Double contact spring sockets	4.00
2 Como or Modern push pull transformers	12.50
1 All American 5-1 ratio Audio transformer	4.75
1 Fada type Inductance switch25
1 Doz. switch points and stops10
3 Univernier New type Dials	3.75
1 Drilled and Engraved Binding post panel75
7 Unmovable binding posts70
1 Pacent Closed Circuit Jack60
1 Pacent Open Circuit Jack50

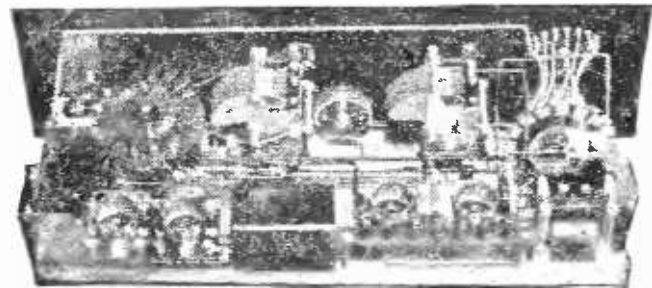

	List Price
1 Eveready C Battery50
8 Feet of high Grade Cambric tubing75
1 Box of assorted sereds, nuts, washers, lugs, etc.....	.50
30 Feet of tinned bus wire75
1 Set of Radio Broadcast blue prints and book of instructions	1.00
	\$60.90

OUR KIT PRICE, POSTPAID, \$42.50

5 Tube Neutrodyne Set with Genuine Fada Neutroformers and Complete High Grade Parts \$39.50

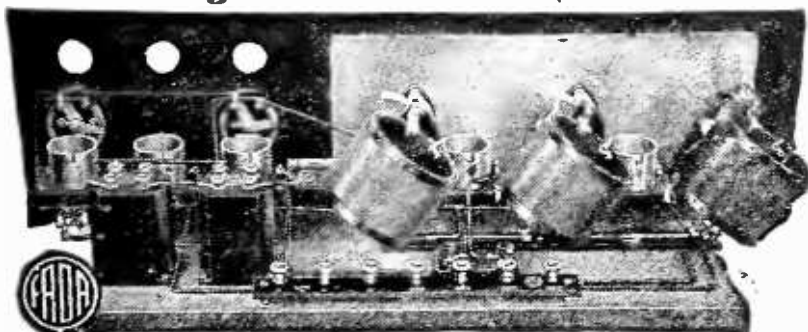

Knock-Down Sets

Consisting of only standard guaranteed parts, drilled and engraved panel with each kit.

3 Tube Cockaday	\$21.50
4 Superdyne Low Loss Coils and Cond.	29.50
8 Tube Phenix Ultradyne.....	63.50
Acme 5 Tube Model S Kit Set	65.00
2 Tube Roberts.....	26.50
3 Stage Resistance Amplifier.....	17.95

SEND MONEY ORDER OR PAY POSTMAN

WHOLESALE RADIO SERVICE CO., Dept. R. B., 9 Church St., N. Y. C.

Twenty-five years of musical experience built into a radio speaker



IN BEAUTIFUL cabinet design and finish as well as in musical acoustic properties, Royal Radio Speaker combines the experience of a quarter of a century in manufacturing high grade pianos and organs.

With the Royal Radio Speaker you always have the best seat in the house. You never seem so near that there is discord nor so far that the delicate overtones of a symphony orchestra or the obligato of a harp is lost.

The Tone Modulator of Royal Radio Speaker has overcome the chief problem of radio amplification, that of preserving all the naturalness of tone of head phones without the distortion or emphasis of interfering noises that is associated with ordinary loud speakers.

The necessity for maximum amplification to bring in distant stations has heretofore presented what seemed to engineers to be an insurmountable difficulty. Royal Radio Speaker has solved it well by the combination of a Scientifically Synchronized Tone Chamber coupled with the Tone Control Modulator.

So unobtrusive is the Royal Radio Speaker that whether operated directly on the radio set or at some point distant, it is never conspicuous. In two finishes, either duo-tone walnut or mahogany, it will add charm to any setting in which it is placed.

Royal Radio Speaker will operate with any radio set where amplification is possible. It is particularly effective with Adler-Royal Neutrodyne and in cabinet design harmonizes perfectly with Adler-Royal instruments.

Royal Radio Speakers are on sale at high class dealers everywhere. If your dealer does not carry it, please address us.

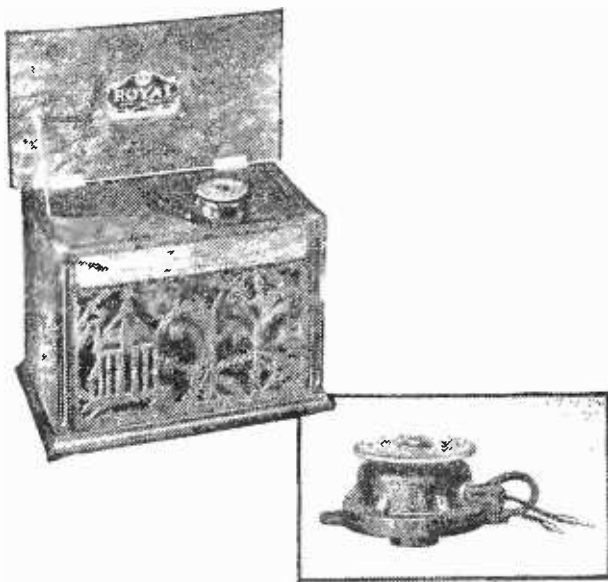

The Royal Radio Speaker Modulator

THE tone modulator makes accurate shading of tone possible without distortion or magnifying interfering noises. The modulator is readily accessible merely by lifting the lid.



Price \$30.00

ADLER MANUFACTURING COMPANY, Inc.
General Sales Office: Dept. C 2, 881 Broadway, New York City
Factories: Louisville, Ky.

Adler-Royal Radio Speaker

ADLER MANUFACTURING CO.
Dept. C 2, 881 Broadway, New York City
Gentlemen:- I am unable to secure a Royal Radio Speaker from my dealer. I therefore enclose herewith my check for \$30.00 so that you may send one to me direct—all shipping charges to be prepaid by you.

My dealer's name is.....
Address.....
My name is.....
Address.....

★ Tested and approved by RADIO BROADCAST ★

Combines distance, selectivity, power, deep full tone, beauty and simplicity!

Looks like—and performs like—a \$200 radio set

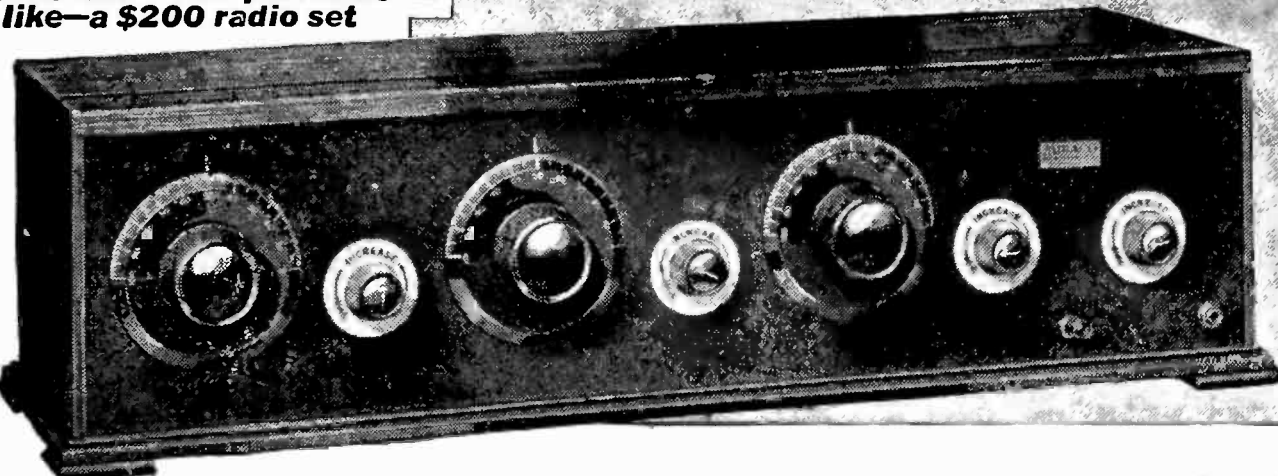

BUILT TO GIVE LOUD SPEAKER ENTERTAINMENT FROM STATIONS THOUSANDS OF MILES DISTANT WHILE LOCAL STATIONS ARE BROADCASTING

MIRACO RADIO GETS 'EM COAST TO COAST

Iowa Hears Cuba
My Miraco is working fine. Have had Havana, Cuba, and all of the stations along

the coast in the United States.—

J. F. Abraham, Talleyrand, Iowa.

Oklahoma Hears Europe

Nov. 27th, was able to get two of the foreign stations on my Miraco, also Porto Rico and Guatemala, Mexico.—W. J. Lowe, Verdun, Okla.

Michigan Hears Germany

My Miraco is working fine. Nov. 28th I got 5 NO, Newcastle, England and LP, Berlin, Germany. Can you beat that record?—Thomas Walker, Howell, Mich.

Pennsylvania Hears Paris

Believe Miraco the best distance-getter on the market for the price. Nov. 24th I picked up Paris, also Havana, Cuba and San Juan, Porto Rico. Nov. 25th I picked up 5 NO, Newcastle, England. Nov. 27th got 5 NO and 2 BD, Aberdeen, Scotland. Now have 98 other stations on my log to date including KGO, Oakland, Cal.—Earl C. Way, Coleman, Pa.

Indiana Hears Europe

Nightly
During the European test I had some foreign station every night on my Miraco. Nov. 22nd I also heard New York, Los Angeles, Canada, Texas, and 31 others.—C. J. D. Rudolph, Evansville, Ind.

Kansas Hears Coast to Coast

Am using a Miraco and will let the following list of stations tell what I think of your sets. These are not all the stations I have tuned in as I do not "log" a station unless I hear it at least twice. The unrecorded stations include several in Canada, two in Mexico and one in Cuba. Expect to do better still: KHJ, KFI, Los Angeles; KGO, Oakland, Cal.; KPO, KVO, San Francisco; WBZ, Springfield, Mass.; WGY, Schenectady, N. Y.; WOO, Philadelphia; WSB, Atlanta, Ga.; KFDX, Shreveport, La.; WOAI and WCAR, San Antonio, Tex.; WFAA, Dallas, Tex.; WGR, Buffalo; WBAH, Minneapolis; WCAM, Villanova, Pa.; KSD, St. Louis; WOAW, Omaha; KOKA, Pittsburgh; WEBH, Chicago; WGN and WMAQ, Chicago; WTAS, Elgin, Ill., and twenty others in Missouri, Kansas, Iowa, Illinois, Minnesota, Nebraska and Oklahoma.—J. A. West, Augusta, Kan.

The Marvelous **MIRACO** Ultra 5

- costs only \$ **75**

★

Send for free bulletins and **SPECIAL OFFER** today!

[FIVE TUBE OUTFIT IN BEAUTIFUL SOLID MAHOGANY CASE]

Completely built, thoroughly tested and factory guaranteed by one of America's oldest and most reliable manufacturers of quality sets! Years of experience and quantity production explain its almost incredible price. Users say that friends who see and hear it are amazed that it sells for less than \$150 or \$200. Radio experts, who know good construction and quality parts, are equally astonished. You, too, will be delighted, thrilled, amazed with your big five-tube Miraco Ultra 5 in its beautiful hand-rubbed solid mahogany cabinet!

Imagine getting all this for \$75—a beautiful sweet toned "coast to coast

loud speaker" set, composed of finest parts, equipped with the latest improvements, refinements and features found on costliest sets. An instrument approved by radio's highest authorities! A set anyone can connect and operate. Even beginners learn quickly to cut through the "locals," get distant stations loud and clear, log stations and return to them at will. (Full directions with each set.) It is non-radiating, non-distorting, non-howling. Has cut-out switch—and a first stage phone jack for tuning—on Bakelite panel. All wiring concealed under Bakelite sub-base. Works on storage battery or dry cells. Literature describes other newest features.



Other Miraco Long Distance Sets \$14³⁵ up



Miraco Model R justly deserves its title, "Radio's finest low priced quality receiver." One tube acts as a tuned radio frequency amplifier and detector combined. A great distance getter. Easy to operate and log. Covers all wave lengths 150 to 625 meters. Like all Miraco sets, it operates on a storage battery or dry cells. Never such value before at only \$14.35. Send coupon today!



This wonderful new Miraco Model R-3 is the three-tube, long distance, loud speaker set that has created such a sensation. Easy to tune and log. Covers wave lengths 150 to 625 meters. Detector acts also as a tuned radio frequency amplifier. 2 stages audio frequency amplification. Has no equal for simplicity, volume, range or clearness at anywhere near its price of \$29.50. Use coupon!

All the Proof you want is waiting for You!

Reports from the many users in every state prove Miraco Tuned Radio Frequency Receivers—at rock bottom prices—have efficiency of sets costing up to three times as much. Remember that Miraco Sets are the product of a long established, reputable manufacturer—pioneer builders of sets. Send for further evidence that they are Radio's finest moderately priced receivers. All Miraco sets bear the endorsement of radio's highest authorities. Mail coupon now for latest bulletins, SPECIAL OFFER and plenty of additional testimony from users leaving no doubt that "Miraco Radio Gets 'em Coast to Coast."

Dealers! Jobbers! Agents!

Write for the new Miraco proposition. The wonderful tone, volume and distance-getting ability of Miraco Sets makes them easy to sell. Send coupon for proposition; good territory open.

Send coupon for free bulletins or order direct from this ad

MIDWEST RADIO CORPORATION
Pioneer Builders of Sets, 406-T E. Eighth St., Cincinnati, O.
Send free literature, SPECIAL OFFER and all particulars regarding Miraco Sets. () Jobber () Dealer () Agent () User

NAME.....
ADDRESS.....
.....

★ Tested and approved by RADIO BROADCAST ★

3 Tubes DO THE WORK OF 6



Crosley Trirdyn Special, \$60.00
With tubes and Crosley Phones \$75.75

In the CROSLEY Trirdyn

SINCE the inception of radio, the results obtained with Armstrong Regenerative Receivers have been the goal of comparison for all others. Trick circuits have been designed to get around the Armstrong Patent, hoping to obtain results "just as good." This has resulted in the use of more tubes, necessary without, but unnecessary with regeneration.

This is one reason why Crosley Radios, licensed under Armstrong U. S. Patent No. 1,113,149 have performed everywhere so remarkably on so few tubes.

The Crosley Trirdyn, employing Armstrong Regeneration combined with tuned non-oscillating radio frequency amplification and reflexed audio frequency amplification and using only three tubes, consistently gives greater selectivity, more volume and wider range than can be obtained where five or six tubes are employed without regeneration. With no regeneration, two stages of radio frequency amplification, requiring at least two additional tubes, must be employed in front of the detector tube to get the same results as furnished by one tube where regeneration is used. Every additional tube means additional expense; an added dial to tune, greater difficulty in operation, more distortion and more tube noises. The three tube Crosley Trirdyn has only two dials. These operate but two circuits, making tuning and logging very easy.

You can't beat the results obtained from an Armstrong Regenerative Crosley Radio. A trial will convince you.

**BEFORE YOU BUY—COMPARE
YOUR CHOICE WILL BE A CROSLEY**

For Sale By Good Dealers Everywhere

*Crosley Regenerative Receivers are licensed under Armstrong
U. S. Patent 1,113,149*

Prices West of Rockies—Add 10%

Write for Complete Catalogue

THE CROSLEY RADIO CORPORATION

Powel Crosley, Jr., President

220 Sassafras St.

Cincinnati, Ohio

Crosley Owns and Operates Broadcasting Station WLW



Crosley One Tube
Model 50, \$14.50
With tube and Crosley Phones \$22.25



Crosley Two Tube
Model 51, \$18.50
With tubes and Crosley Phones \$30.25

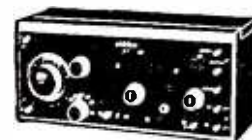

Crosley Three Tube
Model 52, \$30.00
With tubes and Crosley Phones \$45.75

CROSLEY
Better—Costs Less
Radio

Crosley
Head Phones
Better—Cost Less
\$3.75



Crosley Trirdyn Regular, \$50.00
With tubes and Crosley Phones \$65.75



Crosley Trirdyn Newport, \$85.00
With tubes and Crosley Phones \$100.75

Mail
This
Coupon
At Once

The Crosley
Radio Corp'n.
220 Sassafras St.
Cincinnati, O.
Mail me, free of
charge, your catalog
of Crosley receivers
and parts.

Name _____

Address _____

★ Tested and approved by RADIO BROADCAST ★

THE COUNTRY LIFE PRESS, GARDEN CITY, NEW YORK